



**VOICE-VIDEO-DATA**  
**CONNECTIVITY SOLUTIONS**



**STEREN**<sup>®</sup>

ELECTRONICS GROUP



**STEREN ELECTRONICS INTERNATIONAL, LLC.** 6260 Sequence Drive, Suite 110, San Diego, California 92121  
Toll Free 800-266-3333 Fax 800-266-3334 [www.sterenusa.com](http://www.sterenusa.com)



**Welcome to the Steren**  
Connectivity Solutions Catalog,  
the ultimate source for all  
your voice, video and data  
connectivity needs.

For more than 50 years, Steren has been committed to delivering technology excellence, supplying thousands of products used in broadband service drop installations, premises audio/video systems, digital telephony/VoIP networks, data and networking systems and fiber optic networks.

As part of the Steren Group of Companies, we offer one of the largest product portfolios in the electronics world. We remain on the cutting edge from concept, design, engineering and production to performance testing, quality assurance and technical support. Using the latest breakthroughs in technology, Steren remains the undisputed leader in voice, video and data connectivity solutions.

Steren is a proud Certified Minority Business Enterprise (MBE). We recognize the value of diversity and strive to incorporate diversity into every aspect of our business environment.

Thank you for choosing Steren,



*David Shteremberg*  
*Pepe Zyman*

**Partners**  
**The Steren Group**

For more information, contact us at (800) 266-3333  
Or visit our website at [www.sterenusa.com](http://www.sterenusa.com)

# Introduction

## The Steren Group of Companies

The Steren Group of companies is committed to delivering the finest quality products and the highest level of customer service to ensure superior value to our customers and their consumers.

Serving globally, our presence is firmly entrenched in the broadband and communications industries with coast-to-coast United States distribution facilities, over 220 engineers and developers throughout the United States, Mexico and South East Asia, as well as over 300 franchise Steren retail and SterenShop stores in Mexico.

Our Steren Group family represents a solid organization in the engineering, design, manufacture and distribution of leading-edge electronics, interconnection products and consumer electronics. We offer a wide variety of innovative solutions to produce industry-leading results.



Steren, the undisputed leader in voice, video and data solutions, providing the highest quality products used in broadband service drop installations, premises audio/video connectivity systems, VoIP/digital networks, data and networking systems and fiber optic networks. [www.sterenusa.com](http://www.sterenusa.com)



Jumper Shop, a premier manufacturer/supplier of custom broadband connectivity solutions, offering installation hardware, custom fiber cable, mini-coax/wire harnesses and much more. [www.jumpershop.com](http://www.jumpershop.com)



CASE-SRS, a major distributor of installation supplies and accessories to the satellite, broadband and structured wiring industries. [www.case-srs.com](http://www.case-srs.com)



Electrónica Steren S.A. de C.V., the major electronics retailer in Mexico and a pioneer in the sales and distribution of electronics products and components, based in Mexico City. [www.steren.com.mx](http://www.steren.com.mx)



SterenShop, a boutique electronics store offering a wide range of electronics accessories and many exciting novelty products to the consumer. [www.sterenshopusa.com](http://www.sterenshopusa.com)

**USA Corporate Headquarters**  
STEREN ELECTRONICS INTERNATIONAL  
6260 Sequence Drive, Suite 110  
San Diego, CA 92121  
**Toll Free 800-266-3333 Fax 800-266-3334**  
[www.sterenusa.com](http://www.sterenusa.com)

**México Corporate Headquarters**  
ELECTRONICA STEREN S.A DE C.V  
Calz. Camarones No. 112 (esq. eje 2 norte)  
Col. Obrero Popular, 02840 México, D.F.  
**Toll Free 55-5354-2200 cib 60 líneas**  
[www.steren.com.mx](http://www.steren.com.mx)

# Table of Contents



## AUDIO/VIDEO

### Hardware

Video Connectors.....	7-20
Audio Connectors.....	20-24
Drop Hardware.....	25-31
Fasteners.....	31-35
Miscellaneous.....	35-36
Switches & Modulators.....	37

### Mounts

Mounting Brackets.....	38-39
------------------------	-------

### Cables

Audio.....	39-44
RG59.....	45
RG6.....	46
Composite/S-Video.....	47
Component/SVGA.....	48
SVGA/VGA/DVI.....	49
HDMI®/Coaxial.....	49-50
HDMI® Accessories.....	51
Other Video.....	52



## COMMUNICATIONS

### Hardware

Coupler/Adapters.....	55-56
Modular Connectors.....	56-57
Fasteners.....	57
Miscellaneous.....	58-60
RJ11 / 12 & RJ45.....	61

### Cables

CAT5E/CAT6.....	62
USB/SUB/IEEE.....	63-64



## WALL PLATES

Audio/Video.....	67-70
Telephony.....	71-74

### Custom Networking

Wall Plates.....	74-77
Modular Jacks.....	77-80
Patch Panels.....	81-82



## FASTHOME™

Modules & Accessories.....	85
Enclosures.....	86



## TOOLS & METERS

### Audio/Video

Compression Tools.....	89
Crimp Tools.....	89
Cable Preparation Tools.....	90
Security Tools.....	90
Fiber Tools.....	90

### Datacom/Telephony

Modular-Plug Tools.....	91
Punch-Down Tools & Blades.....	92
D-Sub Installation tools.....	92

### Meter/Test Equipment

Digital Multimeters.....	93
Satellite Finders/Meters.....	94-95
Network Cable Testers.....	95
Test Equipment Accessories.....	95

### Installation/Miscellaneous

Tool Bags & Pouches.....	96
Miscellaneous/Cable Tools.....	96-98



## BULK CABLE

Coaxial Cable.....	101-102
Audio Cable.....	103-104
Telephony.....	104

Datacom.....	105
Structured Wire.....	106
Thermostat Cable.....	107



## POWER

Power Adapters.....	111
Power Cords.....	112

Power Strips.....	112-114
Power Miscellaneous.....	114

Charge Card Application.....	116
Credit Application.....	117-118
Order Form Application.....	119-120
Product Index.....	121-124

# Steren Catalog Logo Legend

## General/Standard Icons, Logos & Symbols:



New Item



Products Complies with  
Canadian Standards Association



Products Verified by Intertek  
ETL Semko



Product Listed by Underwriters  
Laboratories in the U.S.



Product Listed by Underwriters  
Laboratories in Canada and the U.S.



Product Listed by Underwriters  
Laboratories (Component)  
in Canada and the U.S.

## Coaxial Products, Satellite/CATV Drop Installation materials:



Environmentally Friendly Product



Port Caps protected by  
Plastic Covers



Steren SkyTracker™  
Satellite Signal Meters

## Audio/Video Connectivity Telephony & Twisted-Pair Products



Digital Visual Interface  
Compatible Product



50µm Gold Plating



100% Factory Tested Product



Product Complies with Category 3  
Voice Grade Specifications



Product Complies with  
Category 5 or 5E Specifications



Product Complies with  
Category 6 Specifications



Steren Fast-Home™ Fast Media  
Home Network Systems Product



Steren Fast Media  
Home Network Systems Product



GripClip™ Mounting Clip



Contains UV Inhibitor™ additive for  
ultraviolet ray protection

## Datacom Connectivity Products:



IEEE-1394 Compatible Product



USB-Compatible Product

## Resale Packaged Icon:



Resale Packaged



www.sterenusa.com

## Copyright Notice

© 2011 Steren Electronics, LLC. All Rights reserved. No portion of this publication may be reproduced in any form or any means, electronic or mechanical, nor may photographs or drawings be reproduced for any purpose without the express written permission of laws of the United States. Steren, Proam are trademarks of Steren Electronics International, LLC. Other trademarks referenced are the property of their respective owners.



audio/video audio/video audio/video



audio/video





### Universal F Compression Connector

- High performance RG6 F compression connector
- Universal for standard, tri-shield, or quad shielded SCTE and SBCA specification RG6 coaxial cable
- Manufactured of high quality brass with nickel plating
- Patented Internal Compression design offers excellent RFI shielding properties
- Designed to be watertight for outdoor applications
- Internal O-ring fully seals the connector collar, ensuring reliability and high performance



**CPS-6STQ-P** F Compression Connector RG6

### F Compression Connector

- One piece all metal design
- Universal for 60% through quad shield RG-59 cable
- Meets all applicable SCTE specifications
- Weather-sealed nut seals without separate port seals or thread protectors
- Excellent shielding protection



**PCT-DRS-59** F Compression Connector RG59

### BNC Compression Connector

- One piece all metal design
- Universal for 60% through quad shield RG59 and RG6 cables
- Meets all applicable SCTE specifications
- Weather-sealed nut seals without separate port seals or thread protectors
- Excellent shielding protection



**AP-BNC-59** BNC Compression Connector RG59  
**AP-BNC-6** BNC Compression Connector RG6

### RCA Compression Connector

- One piece all metal design
- Universal for 60% through quad shield RG6 cable
- Meets all applicable SCTE specifications
- Weather-sealed nut seals without separate port seals or thread protectors
- Excellent shielding protection



**AP-RCA-6** RCA Compression Connector RG6

### F TaperSeal™ Connector

- Commercial grade crimp connector
- Suitable for coaxial broadband networks used in video, data and telephony applications with standard shield cable types
- Conical tapered swedge termination
- Precision machined annealed-brass construction
- Internal neoprene o-ring weather sealed
- 7/16" Hex 4.3mm wide heavy duty easy-grip nut



**200-017** F Taper Seal Crimp Connector RG59  
**200-017-25** 25ct F Taper Seal Crimp Connector RG59

### F TaperSeal™ Connector

- Commercial grade crimp connector
- Suitable for coaxial broadband networks used in video, data and telephony applications with standard shield cable types
- Conical tapered swedge termination
- Precision machined annealed-brass construction
- Internal neoprene o-ring weather sealed
- 7/16" Hex 4.3mm wide heavy duty easy-grip nut



**200-029** F Taper Seal Crimp Connector RG6  
**200-029-25** 25ct F Taper Seal Crimp Connector RG6

### F Series Connector

- Commercial grade F series connector
- Suitable for coaxial networks used in video, data and telephony applications
- 1/4" Barrel



**200-015** F Hex Crimp Connector RG6

### F Series Connector

- Commercial grade F series connector
- Suitable for coaxial networks used in video, data and telephony applications



**200-025** F Hex Crimp Connector RG6



### F Series Connector

- Commercial grade F series connector
- Suitable for coaxial networks used in video, data and telephony applications



- 200-030** F Hex Crimp Connector RG59  
**200-030-25** 25ct F Hex Crimp Connector RG59  
**200-035** F Hex Crimp Connector RG6  
**200-035-25** 25ct F Hex Crimp Connector RG6

### F Series Connector

- Commercial grade F series connector
- Suitable for coaxial networks used in video, data and telephony applications



- 200-031** F Hex Crimp Connector RG59-Gold  
**200-036** F Hex Crimp Connector RG6 Gold  
**200-036-25** 25ct F Hex Crimp Connector RG6 Gold

### F Series Connector

- Commercial grade F series connector
- Suitable for coaxial networks used in video, data and telephony applications



- 200-039** F Twist On Connector RG6  
**200-039-25** 25ct F Twist On Connector RG6  
**200-040** F Twist On Connector RG59  
**200-040-25** 25ct F Twist On Connector RG59

### F Series Connector

- Commercial grade F series connector
- Suitable for coaxial networks used in video, data and telephony applications



- 200-041** F Twist On Connector RG59 Gold  
**200-041-25** 25ct F Twist On Connector RG59 Gold  
**200-043** F Twist On Connector RG6  
**200-043-25** 25ct F Twist On Connector RG6

### F Crimp Connector

- Commercial grade F crimp connector
- Suitable for coaxial broadband networks used in video, data and telephony applications
- Reliable easy-crimp annealed-brass construction prevents rupturing or cracking



- 200-033** F Hex Crimp Connector RG6/Quad  
**200-033-25** 25ct F Hex Crimp Connector RG6/Quad

### F Crimp Connector

- Commercial grade F crimp connector
- Suitable for coaxial broadband networks used in video, data and telephony applications
- Reliable easy-crimp annealed-brass construction prevents rupturing or cracking



- 200-034** F Hex Crimp Connector RG6/Plenum  
**200-034-25** 25ct F Hex Crimp Connector RG6/Plenum

### F Crimp Connector

- Commercial grade F crimp connector
- Suitable for coaxial broadband networks used in video, data and telephony applications
- Reliable easy-crimp annealed-brass construction prevents rupturing or cracking



- 200-027** F Hex Crimp Connector RG6  
**200-027-25** 25ct F Hex Crimp Connector RG6

### F Crimp Connector

- Commercial grade F crimp connector
- Suitable for coaxial broadband networks used in video, data and telephony applications
- Reliable easy-crimp annealed-brass construction prevents rupturing or cracking



- 200-022** F Hex Crimp Connector RG11



### F Series Connector

- Commercial grade F series connector
- Suitable for coaxial networks used in video, data and telephony applications



**200-037** F Hex Crimp Connector RG6 O Ring  
**200-037-25** 25ct F Hex Crimp Connector RG6 O Ring

### F Series Connector

- Commercial grade F series connector
- Suitable for coaxial networks used in video, data and telephony applications



**200-038** F Hex Crimp Connector RG6 O Ring/Silicone Gel  
**200-038-25** 25ct F Hex Crimp Connector RG6 O Ring/Silicone Gel

### BNC Series Connector

- Commercial grade BNC series connector
- Suitable for video and headend applications



**200-131** BNC Hex Crimp Connector 2pc RG59  
**200-131-10** 10ct BNC Hex Crimp Connector 2pc RG59  
**200-134** BNC Hex Crimp Connector 2pc RG58  
**200-138** BNC Hex Crimp Connector 2pc RG59 Plenum  
**200-139** BNC Hex Crimp Connector 2pc RG6  
**200-139-10** 10ct BNC Hex Crimp Connector 2pc RG6

### BNC Series Connector

- Commercial grade BNC series connector
- Suitable for video and headend applications



**200-141** BNC Hex Crimp Connector 3pc RG6  
**200-141-10** 10ct BNC Hex Crimp Connector 3pc RG6  
**200-143** BNC Hex Crimp Connector 3pc RG59/62  
**200-145** BNC Hex Crimp Connector 3pc RG58  
**200-147** BNC Hex Crimp Connector 3pc RG58A/C

### BNC Connector Crimp Kit

- 75Ω BNC crimp kit
- Nickel-plated connector bodies, ferrules and washers
- Delrin dielectric
- Gold plated center contacts
- Includes RG58/RG59P, RG59/RG6P and RG6/RG8X ferrules



**200-123** BNC Hex Crimp Connector Kit 2pc, 75Ω  
**200-123-10** 10ct BNC Hex Crimp Connector Kit 2pc, 75Ω

### BNC Series Connector

- Commercial grade BNC series connector
- Suitable for video and headend applications



**200-144** BNC Clamp Connector 3pc RG59/62

### BNC Series Connector

- Commercial grade BNC series connector
- Suitable for video and headend applications



**200-122** BNC Twist On Connector RG6  
**200-122-10** 10ct BNC Twist On Connector RG6  
**200-142** BNC Twist-On Connector RG59/62  
**200-142-10** 10ct BNC Twist-On Connector RG59

### BNC Series Connector

- Commercial grade BNC series Connector
- Suitable for video and headend applications



**200-135** BNC Hex Crimp Jack 2pc RG59/62



### BNC Series Connector

- Commercial grade BNC series connector
- Suitable for video and headend applications



**200-148** BNC Jack Panel Mount

### RCA Coaxial Connector

- RCA plug crimp RG59
- 1/4" Ring



**200-060** RCA Hex Crimp Connector RG59

### RCA Coaxial Connector

- RCA plug crimp RG59 with spring strain relief



**200-063** RCA Solder Connector RG59 Gold  
**200-063-10** 10ct RCA Solder Connector RG59 Gold

### UHF Series Connector

- Commercial grade UHF series connector



**200-190** UHF Jack Panel Mount

### UHF Series Connector

- Commercial grade UHF series connector



**200-192** UHF Solder Connector RG8

### UHF Series Connector

- Commercial grade UHF series connector



**200-193** UHF Hex Crimp Connector RG59

### N Series Connector

- Commercial grade N series connector
- Suitable for video and headend applications



**200-720** N Plug Clamp-on RG8A/11/213/214

### N Series Connector

- Commercial grade N series connector
- Suitable for video and headend applications



**200-731** N Jack Panel Mount



### SMA Series Connector

- Commercial grade SMA series connector



**200-844** SMA Plug Hex Crimp 3pc RG58A

### DIN Connector

- Nickel-plated contacts
- Solder terminal
- Black plastic housing with strain relief



**250-220** 8C DIN Plug Connector

### Mini-DIN Connector

- Nickel-plated contacts
- Solder terminals
- Black plastic housing with strain relief



**250-235** 6C Mini-DIN Plug Connector

**250-236** 8C Mini-DIN Plug Connector

### Mini-DIN Connector

- Nickel-plated contact
- Solder terminals
- Black plastic housing with strain relief



**250-238** 4C Mini-DIN Jack Connector

### F Series Adapter

- Commercial grade F series adapter
- Suitable for coaxial networks used in video, data and telephony applications



**200-050** F Jack to F Jack Adapter

**200-050-25** 25ct F Jack to F Jack Adapter

### F Series Adapter

- Commercial grade F series adapter
- Suitable for coaxial networks used in video, data and telephony applications



**200-056** 3/8" Nut-Washer for F-Fittings

### F Series Adapter

- Commercial grade F series adapter
- Suitable for coaxial networks used in video, data and telephony applications



**200-051** F Jack to F Jack Adapter Gold

**200-051-25** 25ct F Jack to F Jack Adapter Gold

### F Series Adapter

- Commercial grade F series adapter
- Suitable for coaxial networks used in video, data and telephony applications



**200-053** F Jack to F Jack Panel Mount Adapter

**200-053-25** 25ct F Jack to F Jack Panel Mount Adapter



### F Series Premium Adapter

- High-performance F splice
- Engineered for high-frequency broadband network and distribution system applications



**200-057** F Jack to F Jack Adapter 1GHz  
**200-057-25** 25ct F Jack to F Jack Adapter 1GHz

### F Series Premium Adapter

- High-performance F splice
- Engineered for high-frequency broadband network and distribution system applications



**200-058** F Jack to F Jack Adapter 2.5GHz  
**200-058-25** 25ct F Jack to F Jack Adapter 2.5GHz

### F Series Premium Adapter

- High-performance F splice
- Engineered for high-frequency broadband network and distribution system applications



**200-059** F Jack to F Jack Adapter 3GHz

### F Series Adapter

- Commercial grade L-adapter
- Suitable for coaxial networks used in video, data and telephony applications



**200-107** F Jack to F Plug L Adapter  
**200-107-25** 25ct F Jack to F Plug L Adapter

### F Series Premium Adapter

- High-performance L-adapter
- Engineered for high-frequency broadband network and distribution system applications



**200-106** F Jack to F Plug L Adapter 2.5GHz  
**200-106-10** 10ct F Jack to F Plug L Adapter 2.5GHz

### F Series Adapter

- Commercial grade F series adapter
- Suitable for coaxial networks used in video, data and telephony applications



**200-100** F Plug to F Plug Adapter  
**200-100-25** 25ct F Plug to F Plug Adapter

### F Series Adapter

- Commercial grade F series adapter
- Suitable for coaxial networks used in video, data and telephony applications



**200-055** F Jack Panel Mount

### F Series Adapter

- Commercial grade F series adapter
- Suitable for coaxial networks used in video, data and telephony applications



**200-075** F 75-Ohm Terminator  
**200-075-25** 25ct F 75-Ohm Terminator



### F Series Adapter

- Commercial grade F series adapter
- Suitable for coaxial networks used in video, data and telephony applications



**200-103** F Jack to F Quick Plug Adapter  
**200-103-25** 25ct F Jack to F Quick Plug Adapter

### F Series Adapter

- Commercial grade F series adapter
- Suitable for coaxial networks used in video, data and telephony applications



**200-104** F Jack to F Quick Plug Adapter Gold  
**200-104-25** 25ct F Jack to F Quick Plug Adapter Gold

### F Series Adapter

- Gold-plated brass construction
- Used with round-cavity decorator-style inserts
- F Adapter



**251-503** F Jack to F Jack Panel Mount Adapter  
**251-503-10** 10ct F Jack to F Jack Panel Mount Adapter

### F Series Adapter

- Commercial grade F series adapter
- Suitable for coaxial networks used in video, data and telephony applications



**200-045** RCA Jack to F Plug Adapter  
**200-045-25** 25ct RCA Jack to F Plug Adapter

### F Series Adapter

- Commercial grade F series adapter
- Suitable for coaxial networks used in video, data and telephony applications



**200-108** BNC Jack to F Plug Adapter  
**200-108-25** 25ct BNC Jack to F Plug Adapter

### BNC Series Adapter

- Commercial grade BNC series adapter
- Suitable for video and headend applications



**200-160** BNC Jack to BNC Jack Adapter  
**200-160-10** 10ct BNC Jack to BNC Jack Adapter

### BNC Series Adapter

- Commercial grade BNC series adapter
- Suitable for video and headend applications



**200-165** BNC Jack-Jack Panel Mount Adapter

### BNC Series Adapter

- Commercial grade BNC series adapter
- Suitable for video and headend applications



**200-133** BNC Plug to BNC Plug Adapter



**BNC Series Adapter**

- Commercial grade BNC series adapter
- Suitable for video and headend applications



**200-150** BNC Jack T-Adapter

**BNC Series Adapter**

- Commercial grade BNC series adapter
- Suitable for video and headend applications



**200-155** 2-BNC Jack to BNC Plug T Adapter  
**200-155-10** 10ct 2-BNC Jack to BNC Plug T Adapter

**BNC Series Adapter**

- Commercial grade BNC series adapter
- Suitable for video and headend applications



**200-175** BNC Plug Terminator 50-Ohm 5%  
**200-177** BNC Plug Terminator 75-Ohm 5%  
**200-178** BNC Plug Terminator 75-Ohm 1%

**BNC Series Adapter**

- Commercial grade BNC series adapter
- Suitable for video and headend applications



**200-158** BNC Jack to BNC Plug L Adapter

**BNC Series Adapter**

- Commercial grade BNC series adapter
- Suitable for video and headend applications



**200-130** F Jack to BNC Plug Adapter  
**200-130-10** 10ct F Jack to BNC Plug Adapter

**BNC Series Adapter**

- Commercial grade BNC series adapter
- Suitable for video and headend applications



**200-173** RCA Jack to BNC Plug Adapter  
**200-173-10** 10ct RCA Jack to BNC Plug Adapter

**BNC Series Adapter**

- Commercial grade BNC series adapter
- Suitable for video and headend applications



**200-132** BNC Plug to UHF Jack Adapter

**Audio/Video Adapter**

- Black molded plastic construction
- Nickel contacts



**251-115** RCA Jack to RCA Jack Adapter  
**251-115-10** 10ct RCA Jack to RCA Jack Adapter





### Audio/Video Adapter

- Black molded plastic construction
- Gold-plated contacts



**251-117** 3-RCA Jack to 3-RCA Jack Adapter  
**251-117-10** 10ct 3-RCA Jack to 3-RCA Jack Adapter

### Audio/Video Adapter

- Black molded plastic construction
- Gold-plated contacts



**251-116** RCA Jack to RCA Jack Adapter Gold  
**251-116-10** 10ct RCA Jack to RCA Jack Adapter Gold

### Audio/Video Adapter

- Black molded plastic construction
- Nickel-plated contacts



**251-110** RCA Plug to RCA Plug Adapter

### Audio/Video Adapter

- Black molded plastic construction
- Gold-plated contacts



**251-113** RCA Plug to 2-RCA Jack Y Adapter  
**251-113-10** 10ct RCA Plug to 2-RCA Jack Y Adapter

### Audio/Video Adapter

- Black molded plastic construction
- Gold-plated contacts



**251-111** RCA Jack to RCA Plug L Adapter  
**251-111-10** 10ct RCA Jack to RCA Plug L Adapter

### Audio/Video Adapter

- Black molded plastic construction
- Gold-plated contacts



**251-153** S-Video Jack to RCA Plug Adapter  
**251-153-10** 10ct S-Video Jack to RCA Plug Adapter

### Audio/Video Adapter

- Black molded plastic construction
- Gold-plated contacts



**251-154** S-Video Plug to RCA Plug Adapter

### RCA Coaxial Adapter

- Commercial grade RCA coaxial adapter



**200-110** F Jack to RCA Plug Adapter  
**200-110-25** 25ct F Jack to RCA Plug Adapter



**RCA Coaxial Adapter**

- Commercial grade RCA coaxial adapter



**200-170** BNC Jack to RCA Plug Adapter  
**200-170-10** 10ct BNC Jack to RCA Plug Adapter

**RCA Coaxial Adapter**

- Commercial grade RCA coaxial series adapter



**200-196** UHF-Jack to RCA-Plug Adapter

**Audio/Video Adapter**

- Gold-plated brass construction
- Used with round-cavity decorator-style inserts
- RCA connectors with red insulators



**251-505** RCA Jack to RCA Jack Panel Mount Adapter Red Insulator  
**251-505-10** 10ct RCA Jack to RCA Jack Panel Mount Adapter Red Insulator

**Audio/Video Adapter**

- Gold-plated brass construction
- Used with round-cavity decorator-style inserts
- RCA connectors with white insulators



**251-506** RCA Jack to RCA Jack Panel Mount Adapter White Insulator  
**251-506-10** 10ct RCA Jack to RCA Jack Panel Mount Adapter White Insulator

**Audio/Video Adapter**

- Gold-plated brass construction
- Used with round-cavity decorator-style inserts



**251-507** RCA Jack to F Jack Panel Mount Adapter Red Insulator  
**251-507-10** 10ct RCA Jack to F Jack Panel Mount Adapter Red Insulator

**Audio/Video Adapter**

- Gold-plated brass construction
- Used with round-cavity decorator-style inserts



**251-508** RCA Jack to F Jack Panel Mount Adapter White Insulator  
**251-508-10** 10ct RCA Jack to F Jack Panel Mount Adapter White Insulator

**F Series Adapter**

- Commercial grade F series adapter
- Suitable for coaxial networks used in video, data and telephony applications



**200-117** F Jack to 3.5 Mono Plug

**Audio/Video Adapter**

- Black molded plastic construction
- Gold-plated contacts



**251-151** RCA Jack to S-Video Jack Adapter



### Audio/Video Adapter

- Black molded plastic construction
- Gold-plated contacts



**251-152** RCA Jack to S-Video Plug Adapter  
**251-152-10** 10ct RCA Jack to S-Video Plug Adapter

### Audio/Video Adapter

- Black molded plastic construction
- Gold plated contacts



**251-410** S-Video Jack to S-Video Jack Adapter  
**251-410-10** 10ct S-Video Jack to S-Video Jack Adapter

### UHF Series Adapter

- Commercial grade UHF series adapter
- Suitable for video and headend applications



**200-197** UHF Jack to Plug L Adapter

### UHF Series Adapter

- Commercial grade UHF series adapter
- Suitable for video and headend applications



**200-198** UHF Jack to UHF Jack Adapter

### UHF Series Adapter

- Commercial grade UHF series adapter
- Suitable for video and headend applications



**200-199** UHF 2-Jack to UHF Plug T Adapter

### UHF Series Adapter

- Commercial grade UHF series adapter
- Suitable for video and headend applications



**200-194** F Jack to UHF Plug Adapter

### UHF Series Adapter

- Commercial grade UHF series adapter
- Suitable for video and headend applications



**200-195** BNC Jack to UHF Plug Adapter

### N Series Adapter

- Commercial grade N series adapter
- Suitable for video and headend applications



**200-734** N Coupler Jack-Jack



**N Series Adapter**

- Commercial grade N series adapter
- Suitable for video and headend applications



**200-748** BNC Jack to N Plug Adapter

**N Series Adapter**

- Commercial grade N series adapter
- Suitable for video and headend applications



**200-750** UHF Jack to N Plug Adapter

**SMA Series Adapter**

- Commercial grade SMA series adapter



**200-866** SMA Jack to Plug L-Adapter

**SMA Series Adapter**

- Commercial grade SMA series adapter



**200-870** BNC Jack to SMA Plug Adapter

**SMA Series Adapter**

- Commercial grade SMA series adapter



**200-872** UHF Jack to SMA Plug Adapter

**SMA Series Adapter**

- Commercial grade SMA series adapter



**200-874** N Jack to SMA Plug Adapter

**SMA Series Adapter**

- Commercial grade SMA series adapter



**200-882** SMA Jack to BNC Plug Adapter

**SMA Series Adapter**

- Commercial grade SMA series adapter



**200-886** SMA Jack to N Plug Adapter



### DVI to VGA HD15 Adapter

- Ideal for TVs, flat panel displays, VGA monitors and RGB projectors/displays
- Allows analog connections between a DVI-A device and VGA/SVGA port on a TV, computer, projector or monitor
- Fully molded construction



**516-005** DVI-I Jack to DEHD15 Plug Adapter

### DVI to VGA HD15 Adapter

- Ideal for TVs, flat panel displays, VGA monitors and RGB projectors/displays
- Allows analog connections between a DVI-A device and VGA/SVGA port on a TV, computer, projector or monitor
- Fully molded construction



**516-006** DE15HD Jack to DVI-A Plug Adapter

### HDMI® to DVI Adapter

- Ideal for HDTV sets, DVD players/recorders, set-top boxes and flat-panel displays
- Provides superior connections between HDMI and DVI-D single-link devices
- Fully molded construction



**516-007** HDMI Jack to DVI-D Plug Adapter

### HDMI® to DVI Adapter

- Ideal for HDTV sets, DVD players/recorders, set-top boxes and flat-panel displays
- Provides superior connections between HDMI and DVI-D single-link devices
- Fully molded construction



**516-008** DVI-D Jack to HDMI Plug Adapter

### HDMI® Adapter and Coupler

- High-definition multimedia interface adapter
- Slim design for tight spaces
- 90 Degree port saver



**528-001** HDMI Jack to Plug Right Angle Adapter

### HDMI® Adapter and Coupler

- High-definition multimedia interface adapter
- 180-Degree adjustable swivel



**528-002** HDMI Jack to Plug Swivel Adapter

### HDMI® Coupler

- High-definition multimedia interface adapter
- Slim design for tight spaces
- 90 Degree right angle coupler



**528-004** HDMI Jack to Jack Right Angle Adapter

### HDMI® Coupler

- High-definition multimedia interface adapter
- 180-Degree adjustable swivel



**528-005** HDMI Jack to Jack Swivel Adapter



### HDMI® Coupler

- High-definition multimedia interface adapter
- Couple 2 HDMI cables for longer runs



**528-006** HDMI Jack to Jack Adapter

## Call to see what other HDMI® Products are Available

Contact your Steren Representative  
for more information

**Phone:** (800) 266-3333

### Audio Phone Plug

- Integral strain relief
- Solder terminals
- Metal-threaded inserts



**250-105** 1/4" Mono Plug Metal Handle

### Audio Phone Plug

- Integral strain relief
- Solder terminals
- Metal-threaded inserts



**250-110** 1/4" Stereo Plug Plastic Handle

### Audio Phone Plug

- Integral strain relief
- Solder terminals
- Metal-threaded inserts



**250-115** 1/4" Stereo Plug Metal Handle

### Audio Phone Plug

- Integral strain relief
- Solder terminals
- Metal-threaded inserts



**250-135** 3.5mm Stereo Plug Plastic Handle

### Audio Phone Plug

- Integral strain relief
- Solder terminals
- Metal-threaded inserts



**250-150** 3.5mm Stereo Plug Metal Handle

### Audio Phone Jack

- Solder terminals



**250-535** 3.5mm Stereo Jack Panel Mount



### Audio Phone Jack

- Integral strain relief
- Solder terminals
- Metal-threaded inserts



**250-540** 3.5mm Mono Jack Plastic Handle

### Audio RCA Phone Connector

- Solder terminals



**250-180** RCA Plug Metal Handle

### Audio RCA Phone Connector

- Solder terminals



**250-613** RCA Jack Metal Handle

### Audio RCA Phone Connector

- Solder terminals



**250-615** RCA Jack Panel Mount Black

### Microphone Connector

- XLR 3C plug panel mount



**250-700** XLR 3C Plug Panel Mount

### Microphone Connector

- XLR 3C jack panel mount



**250-705** XLR 3C Jack Panel Mount

### Microphone Connector

- XLR 3C plug with strain relief



**250-710** XLR 3C Plug

### Microphone Connector

- XLR 3C jack with strain relief



**250-720** XLR 3C Jack



### Audio/Video Connector

- Gold-plated brass construction
- Used with round-cavity decorator-style inserts
- Binding post/banana connectors with red bands



**251-509** Binding Post/Banana Jack Panel Mount Adapter Red Band  
**251-509-10** 10ct Binding Post/Banana Jack Panel Mount Adapter Red Band

### Audio/Video Connector

- Gold-plated brass construction
- Used with round-cavity decorator-style inserts
- Binding post/banana connectors with black bands



**251-510** Binding Post/Banana Jack Panel Mount Adapter Black Band  
**251-510-10** 10ct Binding Post/Banana Jack Panel Mount Adapter Black Band

### Audio/Video Adapter

- Black molded plastic construction
- Nickel-plated contacts



**251-002** 3.5 Jack to 2.5 Plug Stereo Adapter  
**251-002-10** 10ct 3.5 Jack to 2.5 Plug Stereo Adapter

### Audio/Video Adapter

- Black molded plastic construction
- Nickel-plated contacts



**251-004** 2.5 Jack to 3.5 Plug Stereo Adapter  
**251-004-10** 10ct 2.5 Jack to 3.5 Plug Stereo Adapter

### Audio/Video Adapter

- Black molded plastic construction
- Nickel-plated contacts



**251-118** 3.5mm Jack to 3.5mm Jack Stereo Adapter  
**251-118-10** 10ct 3.5mm Jack to 3.5mm Jack Stereo Adapter

### Audio/Video Adapter

- Black molded plastic construction
- Nickel-plated contacts



**251-120** RCA Jack to 1/4 Mono Plug Adapter

### Audio/Video Adapters

- Black molded plastic construction
- Gold-plated contacts



**251-200** RCA Jack to 3.5mm Mono Plug Adapter

### Audio/Video Adapter

- Black molded plastic construction
- Nickel-plated contacts



**251-122** RCA Jack to 3.5mm Mono Plug Adapter





### Audio/Video Adapter

- Black molded plastic construction
- Nickel-plated contacts



**251-130** 2-3.5mm Jack to 3.5mm Plug Stereo Adapter  
**251-130-10** 10ct 2-3.5mm Jack to 3.5mm Plug Stereo Adapter

### Audio/Video Adapter

- Black molded plastic construction
- Nickel-plated contacts



**251-134** 2-3.5 Jack to 2.5 Plug Stereo Adapter

### Audio/Video Adapter

- Black molded plastic construction
- Nickel-plated contacts



**251-150** 3.5mm Mono Jack to RCA Plug Adapter

### Audio/Video Adapter

- Black molded plastic construction
- Nickel-plated contacts



**251-155** 1/4 Stereo Jack to 3.5mm Stereo Plug Adapter

### Audio/Video Adapter

- Black molded plastic construction
- Nickel-plated contacts



**251-156** 3.5mm Mono Jack to 1/4 Mono Plug Adapter

### Audio/Video Adapter

- Black molded plastic construction
- Nickel-plated contacts



**251-160** 3.5mm Stereo Jack to 1/4 Stereo Plug Adapter

### Audio/Video Adapter

- Black molded plastic construction
- Nickel-plated contacts



**251-165** 3.5mm Stereo Jack to 3.5mm Mono Plug Adapter

### Audio/Video Adapter

- Metal body construction
- Nickel-plated contacts



**251-310** XLR Jack to XLR Jack Adapter



### Audio/Video Adapter

- Metal body construction
- Nickel-plated contacts



**251-320** XLR Plug to XLR Plug Adapter

### Audio/Video Adapter

- Metal body construction
- Nickel-plated contacts



**251-330** XLR Jack to 1/4 Mono Plug Adapter

### Audio/Video Adapter

- Metal body construction
- Nickel-plated contacts



**251-340** XLR Plug to 1/4 Mono Plug Adapter

### Audio/Video Adapter

- Black molded plastic construction



**260-700** Toslink Jack to Toslink Jack Adapter

### Coaxial Power Plug

- Black plastic handle with strain relief
- Solder terminal, metal threaded insert



**250-187** 2.1mm Power Plug Plastic Handle

### Banana Plug

- Terminates speaker wires to connect amplifier/receiver and speakers
- Provides durable and secure fit for superior sound quality
- Features push-type installation

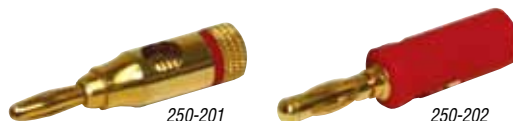

**250-201** 2ct Banana Plug Compression (Black/Red)  
**250-202** 2ct Banana Plug Set Screw (Black/Red)

**Contact your  
Stereon Representative  
for more information**

**Phone:** (800) 266-3333



### 900MHz MATV Splitter

- 5-900MHz 75Ω MATV low-cost F splitter
- Suitable for consumer MATV applications
- Epoxy-sealed back-cover
- Mounting tabs with screws
- Cast-in ground block



**200-202** 2-Way 900MHz Mini RF Splitter

### 900MHz MATV Splitter

- 5-900MHz 75Ω MATV low-cost F splitter
- Suitable for consumer MATV applications
- Epoxy-sealed back-cover
- Mounting tabs with screws
- Cast-in ground block



**200-203** 3-Way 900MHz Mini RF Splitter

### 900MHz MATV Splitter

- 5-900MHz 75Ω MATV low-cost F splitter
- Suitable for consumer MATV applications
- Epoxy-sealed back-cover
- Mounting tabs with screws
- Cast-in ground block



**200-204** 4-Way 900MHz Mini RF Splitter

### 900MHz MATV Splitter

- 5-900MHz 75Ω MATV low-cost F splitter
- Suitable for consumer MATV applications
- Epoxy-sealed back-cover
- Mounting tabs with screws
- Cast-in ground block



**200-206** 6-Way 900MHz Vertical Splitter

### 900MHz MATV Splitter

- 5-900MHz 75Ω MATV low-cost F splitter
- Suitable for consumer MATV applications
- Epoxy-sealed back-cover
- Mounting tabs with screws
- Cast-in ground block



**200-208** 8-Way 900MHz Vertical Splitter

### 900MHz MATV Splitter

- 5-900MHz 75Ω MATV low-cost F splitter
- Suitable for consumer MATV applications
- Epoxy-sealed back-cover
- Mounting tabs with screws
- Cast-in ground block



**200-212** 2-Way 900MHz Mini RF Splitter Gold

### 900MHz MATV Splitter

- 5-900MHz 75Ω MATV low-cost F splitter
- Suitable for consumer MATV applications
- Epoxy-sealed back-cover
- Mounting tabs with screws
- Cast-in ground block



**200-213** 3-Way 900MHz Mini RF Splitter Gold

### 900MHz MATV Splitter

- 5-900MHz 75Ω MATV low-cost F splitter
- Suitable for consumer MATV applications
- Epoxy-sealed back-cover
- Mounting tabs with screws
- Cast-in ground block



**200-214** 4-Way 900MHz Mini RF Splitter Gold



### 900MHz MATV Splitter

- 5-900MHz 75Ω MATV low-cost F splitter
- Suitable for consumer MATV applications
- Epoxy-sealed back-cover
- Mounting tabs with screws
- Cast-in ground block



**200-222** 2-Way 900MHz RF Splitter

### 900MHz MATV Splitter

- 5-900MHz 75Ω MATV low-cost F splitter
- Suitable for consumer MATV applications
- Epoxy-sealed back-cover
- Mounting tabs with screws
- Cast-in ground block



**200-223** 3-Way 900MHz RF Splitter

### 900MHz MATV Splitter

- 5-900MHz 75Ω MATV low-cost F splitter
- Suitable for consumer MATV applications
- Epoxy-sealed back-cover
- Mounting tabs with screws
- Cast-in ground block



**200-224** 4-Way 900MHz RF Splitter

### 1GHz 90dB F-Splitter

- 5-1000MHz 75Ω high-isolation F-splitter
- 90dB min. RFI shielding
- Epoxy-sealed back-cover
- High-performance printed-board circuitry
- Mounting tabs with screws
- Cast-in ground block
- 1" Centered F-ports accommodate security tool



**201-201** 3-Way 1GHz 90dB RF Balanced Splitter

### 1GHz 90dB F-Splitter

- 5-1000MHz 75Ω high-isolation F-splitter
- 90dB min. RFI shielding
- Epoxy-sealed back-cover
- High-performance printed-board circuitry
- Mounting tabs with screws
- Cast-in ground block
- 1" Centered F-ports accommodate security tool



**201-202** 2-Way 1GHz 90dB RF Splitter

### 1GHz 90dB F-Splitter

- 5-1000MHz 75Ω high-isolation F-splitter
- 90dB min. RFI shielding
- Epoxy-sealed back-cover
- High-performance printed-board circuitry
- Mounting tabs with screws
- Cast-in ground block
- 1" Centered F-ports accommodate security tool



**201-203** 3-Way 1GHz 90dB RF Splitter

### 1GHz 90dB F-Splitter

- 5-1000MHz 75Ω high-isolation F-splitter
- 90dB min. RFI shielding
- Epoxy-sealed back-cover
- High-performance printed-board circuitry
- Mounting tabs with screws
- Cast-in ground block
- 1" Centered F-ports accommodate security tool



**201-204** 4-Way 1GHz 90dB RF Splitter

**Contact your  
Steren Representative  
for more information**

**Phone: (800) 266-3333**



### 1GHz 130dB F-Splitter

- 5-1000MHz 75Ω Highest isolation F-splitter
- Soldered-back cover 130dB min. RFI shielding
- High-performance printed-board circuitry
- Mounting tabs with screws
- 1" Centered F-ports accommodate security tool
- Cast-in ground block



**201-222** 2-Way 1GHz 130dB RF Splitter

### 1GHz 130dB F-Splitter - Balanced

- 5-1000MHz 75Ω Highest isolation F-splitter
- Soldered-back cover 130dB min. RFI shielding
- High-performance printed-board circuitry
- Mounting tabs with screws
- 1" Centered F-ports accommodate security tool
- Cast-in ground block



**201-221** 3-Way 1GHz 130dB RF Balanced Splitter

### 1GHz 130dB F-Splitter

- 5-1000MHz 75Ω Highest isolation F-splitter
- Soldered-back cover 130dB min. RFI shielding
- High-performance printed-board circuitry
- Mounting tabs with screws
- 1" Centered F-ports accommodate security tool
- Cast-in ground block



**201-223** 3-Way 1GHz 130dB RF Splitter

### 1GHz 130dB F-Splitter

- 5-1000MHz 75Ω Highest isolation F-splitter
- Soldered-back cover 130dB min. RFI shielding
- High-performance printed-board circuitry
- Mounting tabs with screws
- 1" Centered F-ports accommodate security tool
- Cast-in ground block



**201-224** 4-Way 1GHz 130dB RF Splitter

### 1GHz 130dB One-Side Splitter

- 5-1000MHz 75Ω Highest isolation F-splitter
- Horizontal one-sided input and output ports
- One-sided port design allows close mounting in lock-boxes for easy access of cable connections
- Soldered-back cover 130dB min. EMI-RFI shielding
- High-performance printed-board circuitry
- Mounting tabs with screws
- Cast-in ground block
- Anti-corrosion nickel-plated zinc-alloy cast housing
- 1" Centered F-ports accommodate security tool



**201-282** 2-Way 1GHz 90dB 1-Side RF Splitter

### 1GHz 130dB One-Side Splitter - Balanced

- 5-1000MHz 75Ω highest isolation F-splitter
- Horizontal one-sided input and output ports
- One-sided port design allows close mounting in lock-boxes for easy access of cable connections
- Soldered-back cover 130dB min. EMI-RFI shielding
- High-performance printed-board circuitry
- Mounting tabs with screws
- Cast-in ground block
- Anti-corrosion nickel-plated zinc-alloy cast housing
- 1" Centered F-ports accommodate security tool



**201-281** 3-Way 1GHz 90dB 1-Side RF Balanced Splitter

### 1GHz 130dB One-Side Splitter

- 5-1000MHz 75Ω Highest isolation F-splitter
- Horizontal one-sided input and output ports
- One-sided port design allows close mounting in lock-boxes for easy access of cable connections
- Soldered-back cover 130dB min. EMI-RFI shielding
- High-performance printed-board circuitry
- Mounting tabs with screws
- Cast-in ground block
- Anti-corrosion nickel-plated zinc-alloy cast housing
- 1" Centered F-ports accommodate security tool

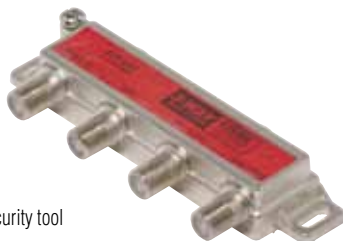

**201-283** 3-Way 1GHz 90dB 1-Side RF Splitter

### 1GHz 130dB One-Side Splitter

- 5-1000MHz 75Ω Highest isolation F-splitter
- Horizontal one-sided input and output ports
- One-sided port design allows close mounting in lock-boxes for easy access of cable connections
- Soldered-back cover 130dB min. EMI-RFI shielding
- High-performance printed-board circuitry
- Mounting tabs with screws
- Cast-in ground block
- Anti-corrosion nickel-plated zinc-alloy cast housing
- 1" Centered F-ports accommodate security tool



**201-284** 4-Way 1GHz 90dB 1-Side RF Splitter



### 1GHz 90dB Vertical F-Splitter

- 5-1000MHz 75Ω High isolation F-splitter
- Vertical port design allows close mounting in lock boxes for easy access of cable connections
- 90dB min. RFI shielding
- Epoxy-sealed back-cover
- High-performance printed-board circuitry
- Mounting tabs with screws
- Cast-in ground block
- 1" Centered F-ports accommodate security tool



201-262 2-Way 1GHz 90dB Vertical RF Splitter

### 1GHz 90dB Vertical F-Splitter - Balanced

- 5-1000MHz 75Ω High isolation F-splitter
- Vertical port design allows close mounting in lock boxes for easy access of cable connections
- 90dB min. RFI shielding
- Epoxy-sealed back-cover
- High-performance printed-board circuitry
- Mounting tabs with screws
- Cast-in ground block
- 1" Centered F-ports accommodate security tool



201-261 3-Way 1GHz 90dB Vertical RF Balanced Splitter

### 1GHz 90dB Vertical F-Splitter

- 5-1000MHz 75Ω High isolation F-splitter
- Vertical port design allows close mounting in lock boxes for easy access of cable connections
- 90dB min. RFI shielding
- Epoxy-sealed back-cover
- High-performance printed-board circuitry
- Mounting tabs with screws
- Cast-in ground block
- 1" Centered F-ports accommodate security tool



201-264 4-Way 1GHz 90dB Vertical RF Splitter

### 1GHz 90dB Vertical F-Splitter

- 5-1000MHz 75Ω High isolation F-splitter
- Vertical port design allows close mounting in lock boxes for easy access of cable connections
- 90dB min. RFI shielding
- Epoxy-sealed back-cover
- High-performance printed-board circuitry
- Mounting tabs with screws
- Cast-in ground block
- 1" Centered F-ports accommodate security tool

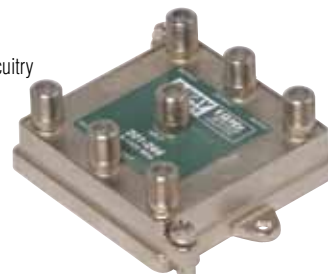

201-266 6-Way 1GHz 90dB Vertical RF Splitter

### 1GHz 90dB Vertical F-Splitter

- 5-1000MHz 75Ω High isolation F-splitter
- Vertical port design allows close mounting in lock boxes for easy access of cable connections
- 90dB min. RFI shielding
- Epoxy-sealed back-cover
- High-performance printed-board circuitry
- Mounting tabs with screws
- Cast-in ground block
- 1" Centered F-ports accommodate security tool

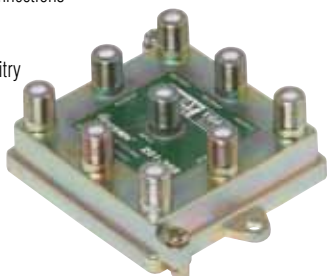

201-268 8-Way 1GHz 90dB Vertical RF Splitter

### 1GHz 130dB Vertical Splitter

- 5-1000MHz 75Ω High isolation F-splitter
- Vertical port design allows close mounting in lock boxes for easy access of cable connections
- 90dB min. RFI shielding
- Epoxy-sealed back-cover
- High-performance printed-board circuitry
- Mounting tabs with screws
- Cast-in ground block
- 1" Centered F-ports accommodate security tool



201-272 2-Way 1GHz 130dB Vertical Splitter

### 1GHz 130dB Vertical Splitter

- 5-1000MHz 75Ω Highest isolation F-splitter
- Vertical port design allows close mounting in lock boxes for easy access of cable connections
- Soldered-back cover 130dB min. RFI shielding
- High-performance printed-board circuitry
- Mounting tabs with screws
- Cast-in ground block
- 1" Centered F-ports accommodate security tool



201-273 3-Way 1GHz 130dB Vertical Splitter

### 1GHz 130dB Vertical Splitter

- 5-1000MHz 75Ω Highest isolation F-splitter
- Vertical port design allows close mounting in lock boxes for easy access of cable connections
- Soldered-back cover 130dB min. RFI shielding
- High-performance printed-board circuitry
- Mounting tabs with screws
- Cast-in ground block
- 1" Centered F-ports accommodate security tool



201-274 4-Way 1GHz 130dB Vertical RF Splitter



### 1GHz 130dB Vertical Splitter

- 5-1000MHz 75Ω Highest isolation F-splitter
- Vertical port design allows close mounting in lock boxes for easy access of cable connections
- Soldered-back cover 130dB min. RFI shielding
- High-performance printed-board circuitry
- Mounting tabs with screws
- Cast-in ground block
- 1" Centered F-ports accommodate security tool

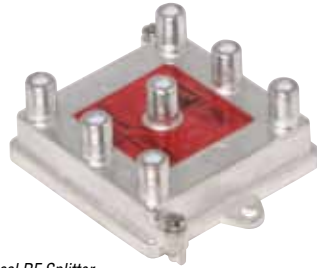

**201-276** 6-Way 1GHz 130dB Vertical RF Splitter

### 1GHz 130dB Vertical Splitter

- 5-1000MHz 75Ω Highest isolation F-splitter
- Vertical port design allows close mounting in lock boxes for easy access of cable connections
- Soldered-back cover 130dB min. RFI shielding
- High-performance printed-board circuitry
- Mounting tabs with screws
- Cast-in ground block
- 1" Centered F-ports accommodate security tool



**201-278** 8-Way 1GHz 130dB Vertical RF Splitter

### 1GHz 130dB Digital Splitter - Balanced

- Premium 1GHz 130dB digital ready splitter
- Broadband and CATV 5-1000MHz 75Ω splitters
- Suitable for hybrid distribution networks, HDTV, voice, data, modem and digital converter applications
- High-performance printed board circuitry
- Soldered-back cover 130dB min. EMI-RFI shielding
- 1" Centered F-ports accommodate security tool



**201-102** 2-Way 1GHz 130dB RF Balanced Digital Splitter

### 1GHz 130dB Digital Splitter - Balanced

- Premium 1GHz 130dB digital ready splitter
- Broadband and CATV 5-1000MHz 75Ω splitters
- Suitable for hybrid distribution networks, HDTV, voice, data, modem and digital converter applications
- High-performance printed board circuitry
- Soldered-back cover 130dB min. EMI-RFI shielding
- 1" Centered F-ports accommodate security tool



**201-101** 3-Way 1GHz 130dB RF Balanced Digital Splitter

### 1GHz 130dB Digital Splitter

- Premium 1GHz 130dB digital ready splitter
- Broadband and CATV 5-1000MHz 75Ω splitters
- Suitable for hybrid distribution networks, HDTV, voice, data, modem and digital converter applications
- High-performance printed board circuitry
- Soldered-back cover 130dB min. EMI-RFI shielding
- 1" Centered F-ports accommodate security tool



**201-103** 3-Way 1GHz 130dB RF Digital Splitter

### 1GHz 130dB Digital Splitter - Balanced

- Premium 1GHz 130dB digital ready splitter
- Broadband and CATV 5-1000MHz 75Ω splitters
- Suitable for hybrid distribution networks, HDTV, voice, data, modem and digital converter applications
- High-performance printed board circuitry
- Soldered-back cover 130dB min. EMI-RFI shielding
- 1" Centered F-ports accommodate security tool



**201-104** 4-Way 1GHz 130dB RF Balanced Digital Splitter

### 1GHz 130dB Digital Splitter - Balanced

- Premium 1GHz 130dB digital ready splitter
- Broadband and CATV 5-1000MHz 75Ω splitters
- Suitable for hybrid distribution networks, HDTV, voice, data, modem and digital converter applications
- High-performance printed board circuitry
- Soldered-back cover 130dB min. EMI-RFI shielding
- 1" Centered F-ports accommodate security tool

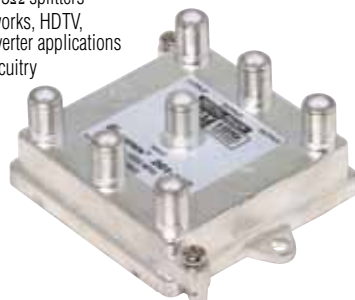

**201-106** 6-Way 1GHz 130dB RF Balanced Digital Splitter

### 1GHz 130dB Digital Splitter - Balanced

- Premium 1GHz 130dB digital ready splitter
- Broadband and CATV 5-1000MHz 75Ω splitters
- Suitable for hybrid distribution networks, HDTV, voice, data, modem and digital converter applications
- High-performance printed board circuitry
- Soldered-back cover 130dB min. EMI-RFI shielding
- 1" Centered F-ports accommodate security tool

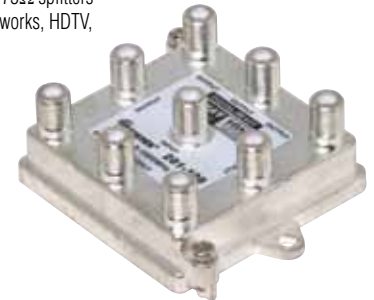

**201-108** 8-Way 1GHz 130dB RF Balanced Digital Splitter



### 2.4GHz Satellite Splitter

- 40-2400MHz 75Ω High-frequency F-splitter
- Suitable for analog and digital satellite applications
- 90dB min. RFI shielding
- Epoxy-sealed back-cover
- High-performance printed-board circuitry
- Mounting tabs with screws
- Cast-in ground block
- DC power passing to one port for remote LNB-powering applications and powering antenna pre-amplifier from headend
- 1" Centered F-ports accommodate security tool



**201-232** 2-Way 2.4GHz 90dB 1 Port Power Pass Splitter

### 2.4GHz Satellite Splitter

- 40-2400MHz 75Ω High-frequency F-splitter
- Suitable for analog and digital satellite applications
- 90dB min. RFI shielding
- Epoxy-sealed back-cover
- High-performance printed-board circuitry
- Mounting tabs with screws
- Cast-in ground block
- DC power passing to one port for remote LNB-powering applications and powering antenna pre-amplifier from headend
- 1" Centered F-ports accommodate security tool

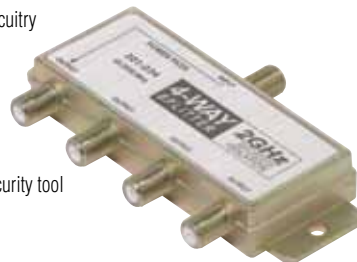

**201-234** 4-Way 2.4GHz 90dB 1 Port Power Pass Splitter

### 2.4GHz Satellite Splitter

- 40-2400MHz 75Ω High-frequency F-splitter
- Suitable for analog and digital satellite applications
- 90dB min. RFI shielding
- Epoxy-sealed back-cover
- High-performance printed-board circuitry
- Mounting tabs with screws
- Cast-in ground block
- DC power passing to one port for remote LNB-powering applications and powering antenna pre-amplifier from headend
- 1" Centered F-ports accommodate security tool



**201-242** 2-Way 2.4GHz 90dB Power Pass Splitter

### 2.4GHz Satellite Splitter

- 40-2400MHz 75Ω High-frequency F-splitter
- Suitable for analog and digital satellite applications
- 90dB min. RFI shielding
- Epoxy-sealed back-cover
- High-performance printed-board circuitry
- Mounting tabs with screws
- Cast-in ground block
- DC power passing to one port for remote LNB-powering applications and powering antenna pre-amplifier from headend
- 1" Centered F-ports accommodate security tool



**201-244** 4-Way 2.4GHz 90dB Power Pass Splitter

### 24 GHz Inline Attenuator Pad

- Inline attenuator pad
- 0-2000MHz Female-to-male inline attenuator
- Monolithic ceramic printed-board circuitry
- 22-Gauge spring-steel center
- Tolerance 5%
- Return loss 20dB typical
- DC blocking



- 201-403** Inline Attenuator Pad 3dB
- 201-406** Inline Attenuator Pad 6dB
- 201-408** Inline Attenuator Pad 8dB
- 201-410** Inline Attenuator Pad 10dB
- 201-412** Inline Attenuator Pad 12dB
- 201-416** Inline Attenuator Pad 16dB
- 201-420** Inline Attenuator Pad 20dB

#### Specifications

Insertion Loss (dB)	Insertion Loss Tolerance (dB)	M-Port Return Loss (min./dB)	F-Port Return Loss (min./dB)
3	1.5	12	12
6	1.5	15	15
8	1.5	15	15
10	1.5	12	12
12	1.5	12	12
16	1.5	15	15
20	1.5	15	15

### 2.4 GHz TV-Satellite Diplexer/Mixer

- 5-2400MHz TV-satellite diplexer
- Separates or combines off-air TV-antenna and satellite signals from or onto a single feed-line
- High-performance printed-board circuitry
- 90dB min. RFI shielding
- Epoxy-sealed back-cover
- 3/8" Precision machined F-connector threads
- DC power passing to one port 500mA max.
- ANT insertion loss 1.2dB @ 40-800MHz, 2.3dB @ 800-860MHz
- SAT insertion loss 3.3dB @ 950-1000MHz, 2.5dB @ 1000-2300MHz
- SAT return loss 12.5dB @ 40-890MHz



**201-252** TV-Satellite Diplexer/Mixer

### 2.4 GHz TV-Satellite Mini-Diplexer

- 5-2400MHz TV-satellite diplexer
- Separates or combines off-air TV-antenna and satellite signals from or onto a single feed-line
- High-performance printed-board circuitry
- 90dB min. RFI shielding
- Epoxy-sealed back-cover
- 3/8" Precision machined F-connector threads
- DC power passing to one port 500mA max.
- ANT insertion loss 1.2dB @ 40-800MHz, 2.3dB @ 800-860MHz
- SAT insertion loss 3.3dB @ 950-1000MHz, 2.5dB @ 1000-2300MHz
- SAT return loss 12.5dB @ 40-890MHz
- Dimensions: 1.12"(W) x 5.8"(H) x 1"(D)



**201-254** TV-Satellite Mini Diplexer/Mixer





### F Ground Block

- Used in CATV grounding applications
- Weather-resistant zinc-alloy cast housing
- 3/16" Grounding holes accept 8 AWG wire
- Includes mounting screws
- UL Listed



**200-271** Single Port F Ground Block 900MHz



### F Ground Block

- Used in CATV grounding applications
- Weather-resistant zinc-alloy cast housing
- 3/16" Grounding holes accept 8 AWG wire
- Includes mounting screws
- UL Listed



**200-272** Dual Port F Ground Block 900MHz



### F Ground Block

- Used in CATV grounding applications
- Weather-resistant zinc-alloy cast housing
- 3/16" Grounding holes accept 8 AWG wire
- Includes mounting screws
- UL Listed



**200-273** Dual Port F Ground Block 900MHz 2-Ground Screws



### F Ground Block

- Used in CATV grounding applications
- Weather-resistant zinc-alloy cast housing
- 3/16" Grounding holes accept 8 AWG wire
- Includes mounting screws
- UL Listed



**200-274** Single Port F Ground Block 1GHz



### F Ground Block

- Used in CATV grounding applications
- Weather-resistant zinc-alloy cast housing
- 3/16" Grounding holes accept 8 AWG wire
- Includes mounting screws
- UL Listed



**200-278** Single Port F Ground Block 2.5GHz 2-Ground Screws



### F Ground Block

- Used in CATV grounding applications
- Weather-resistant zinc-alloy cast housing
- 3/16" Grounding holes accept 8 AWG wire
- Includes mounting screws
- UL Listed



**200-279** Dual Port F Ground Block 2.5GHz 2-Ground Screws



### Ground Strap

- Provides low resistance ground connection for grounding CATV, satellite or telephone drops
- Adjustable easy-install for permanent connection to water pipes or service masts to 10-14 AWG ground wire
- Weather resistant

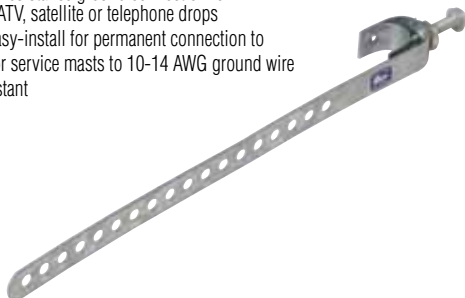

**200-280** 8" Galvanized Steel Ground Strap Suitable for 1/2"-2" Diameter Pipe  
**200-283** 10" Galvanized Steel Ground Strap Suitable for 1/2"-2 1/2" Diameter Pipe

### Ground Strap

- Provides low resistance ground connection for grounding CATV, satellite or telephone drops
- Adjustable easy-install for permanent connection to water pipes or service masts to 10-14 AWG ground wire
- Weather resistant

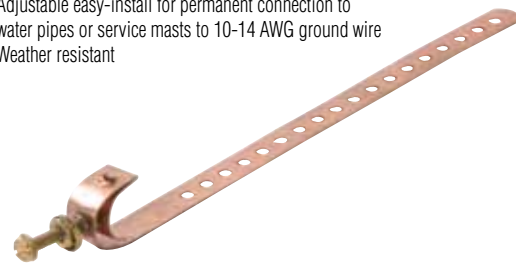

**200-286** 8" Copper Ground Strap Suitable for 1/2"-2" Diameter Pipe  
**200-288** 10" Copper Ground Strap Suitable for 1/2"-2 1/2" Diameter Pipe



### Grounding Rod

- 4' Universal copper-bonded steel rod
- 3/8" High-strength carbon-steel
- Cold-drawn for increased strength
- Conical tapered point eases soil penetration
- Includes hex-bolt ground clamp

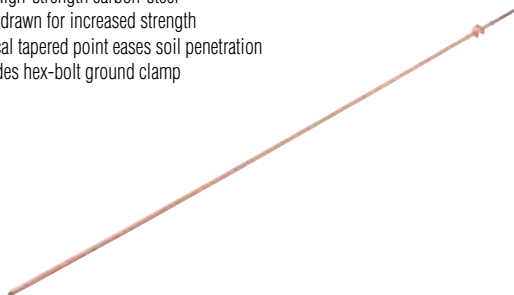

**200-290** 4' x 3/8" Copper Clad Ground Rod

### Grounding Hardware

- High-strength bonding ground clamps
- Exepts 10AWG wire



**200-230** I-Beam Galvanized Steel Ground Clamp

### Grounding Hardware

- High-strength bonding ground clamps



**200-292** 3/8" Acorn Ground Rod Clamp

### Grounding Hardware

- High-strength bonding ground clamps



**200-297** Ground Lug

### Split-Bolt Ground Connector

- High-clamping force split-volt connector
- Suitable for copper or copperweld connections
- Copper-bronze alloy



**200-246** #6 Split Bolt Connector  
**200-248** #8 Split Bolt Connector

### Galvanized Poleline Hardware

- High-quality drop line hardware
- Corrosion-resistant galvanized steel hardware

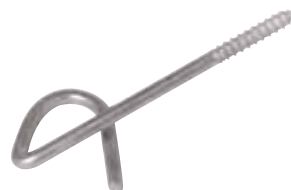

**200-232** P-Hook

### Galvanized Poleline Hardware

- High-quality drop line hardware
- Corrosion-resistant galvanized steel hardware



**200-234** J-Hook

### Galvanized Poleline Hardware

- High-quality drop line hardware
- High-strength cast aluminum jaw clamps
- Corrosion-resistant galvanized steel hardware



**200-236** O-Span Clamp



### Anchor Kit

- Anchor kit with anchors, screws and bit
- Clear plastic container with clasp closure
- Cut-out handle for pegboard hanging
- 100 pcs. 8-10 x 1" Mounting anchors
- 100 pcs. #8 Steel mounting screws
- 1 pc. 1/4" Masonry drill bit
- 6 5/16"(W) x 3 3/8"(H) x 1 1/2"(D)



**220-100** #8 Screw/Anchor Kit w/Drill Bit

### Hex Head Mounting Screw

- 1/4" x 2 1/2" Hex head lag screw



**220-120** 1/4" x 2-1/2" Lag Screw  
**220-215** 5/16" x 2" Lag Screw  
**220-220** 5/16" x 2-1/2" Lag Screw  
**220-225** 5/16" x 3" Lag Screw

### Mounting Anchor

- Lead double expansion anchor 1/4"
- Use 1/2" drill bit



**220-500** 1/4" Double Expansion Lead Anchor

### Cable Siding Clip

- Siding clip for attaching coaxial cable to horizontal aluminum or vinyl siding
- High-impact plastic
- UV Inhibitor™ protects from ultraviolet ray damage



**200-951** Vinyl Siding Clip Horizontal RG59, BK / CL

### Cable Siding Clip

- Siding clip for attaching coaxial cable to horizontal aluminum or vinyl siding
- High-impact plastic
- UV Inhibitor™ protects from ultraviolet ray damage



**200-952** Vinyl Siding Clip Horizontal RG6, BK / CL

### Cable Siding Clip

- Siding clip for attaching coaxial cable to vertical aluminum or vinyl siding
- High-impact plastic
- UV Inhibitor™ protects from ultraviolet ray damage



**200-953** Vinyl Siding Clip Vertical RG59, BK / CL

### Cable Siding Clip

- Siding clip for attaching coaxial cable to vertical aluminum or vinyl siding
- High-impact plastic
- UV Inhibitor™ protects from ultraviolet ray damage



**200-954** Vinyl Siding Clip Vertical RG6, BK / CL

### Coaxial Cable Clip

- 6-7mm Coaxial nail-in fastener
- Attaches to wood, concrete, brick, masonry, plaster
- Zinc-plated pre-inserted Hardened steel nail
- High-impact plastic



**200-955** 100ct RG59 Nail Clip, BK  
**200-961** 100ct Single RG6 Cable Mounting Clip, WH



### Coaxial Cable Clip

- 6-7mm Coaxial nail-in fastener
- Attaches to wood, concrete, brick, masonry and plaster
- Zinc-plated pre-inserted hardened steel nail
- High-impact plastic



**200-960** 100ct Single RG6 Cable Mounting Clip, BK  
**200-962** 100ct Dual RG6 Cable Mounting Clip, BK / WH



### Ground Wire Clip

- 10-14 AWG ground wire clip
- Attaches to wood, concrete, brick, masonry and plaster
- Zinc-plated pre-inserted hardened
- Steel nail
- High-impact plastic



**300-955** Ground Wire Mounting Clip, BK / WH



### Grip-Clip™ Mounting Clip

- Grip-Clip™ cable mounting clip
- Automatically adjusts to coaxial wire size
- Provides strain relief without pinching or damage
- Pre-loaded screws and integral automatic ratchet mechanism allow for easy, one-handed installation
- UV Inhibitor™ protects from ultraviolet ray damage



**200-963** 100ct Grip-Clip™ Single Cable Mounting Clip, BK / GY / WH  
**200-969** 100ct Grip-Clip™ Single Cable Mounting Clip, BK / WH



### Grip-Clip™ Mounting Clip

- Grip-Clip™ cable mounting clip
- Automatically adjusts to coaxial wire size
- Provides strain relief without pinching or damage
- Pre-loaded screws and integral automatic ratchet mechanism allow for easy, one-handed installation
- UV Inhibitor™ protects from ultraviolet ray damage



**200-964** 100ct Grip-Clip™ Dual Cable Mounting Clip, BK / GY / WH



### Grip-Clip™ Mounting Clip

- Grip-Clip™ cable mounting clip
- Automatically adjusts to coaxial wire size
- Provides strain relief without pinching or damage
- Pre-loaded screws and integral automatic ratchet mechanism allow for easy, one-handed installation
- UV Inhibitor™ protects from ultraviolet ray damage



**200-965** 100ct Grip-Clip™ Ground Wire Mounting Clip, BK / GY / WH



### Nylon Cable Clamp

- Clear virgin 6/6 nylon-UL94V2 self-extinguishing clamp



**400-510** 100ct 3/8" Nylon Cable Clamp, CL  
**400-515** 100ct 1/2" Nylon Cable Clamp, CL



### Metal Cable Clamp

- Series 6 cable aluminum cable-clip
- Steel E-drop cable clip



**400-525** 100ct RG6 Aluminum Cable Clip  
**400-530** 50ct E Drop Wire Clip



### Self-Locking Cable Tie

- Self-locking tie-wrap
- Bent finger-grip tip clear virgin nylon 6/6
- UL94V2 Self extinguishing



**400-708** 100ct 8" 120lb Nylon Cable Tie, CL  
**400-715** 100ct 15" 120lb Nylon Cable Tie, CL  
**400-804** 100ct 4" 18lb Nylon Cable Tie, BK, CL  
**400-806** 100ct 6" 18lb Nylon Cable Tie, CL  
**400-808** 100ct 8" 18lb Nylon Cable Tie, BK, CL  
**400-812** 100ct 12" 40lb Nylon Cable Tie, BK, CL  
**400-815** 100ct 15" 40lb Nylon Cable Tie, BK, CL  
**400-828** 100ct 8" 50lb Nylon Cable Tie, BK, CL  
**400-832** 100ct 12" 50lb Nylon Cable Tie, BK, CL  
**400-835** 100ct 15" 50lb Nylon Cable Tie, BK, CL  
**400-841** 100ct 21" 50lb Nylon Cable Tie, BK, CL



### Hook-and-Loop Wire Tie

- Hook-and-loop wire tie
- Nylon strap for tying cable
- 8" Length
- Hook side instantly attaches to loop side
- Easy to reopen and reclose



**400-858** 10ct 8" Hook & Loop Cable Tie, BK

### Matching Transformer

- 75/300Ω Impedance-matching balun
- Bandwidth 5-900MHz UHF-VHF-FM



**200-490** Matching Transformer 75/300Ω Indoor-Outdoor

### Matching Transformer

- 75/300Ω Impedance-matching balun
- Bandwidth 5-900MHz UHF-VHF-FM



**200-500** Matching Transformer 75/300Ω Indoor

### Matching Transformer

- 75/300Ω Impedance-matching balun
- Bandwidth 5-900MHz UHF-VHF-FM



**200-510** Matching Transformer 75/300Ω Quick Connect

### Thread Protector

- Environmentally seals F-Ports
- Compresses to form seal when F-connectors are tightened onto 3/8" threaded ports



**200-959** 100ct F Thread Protector, BK

### Security Shield

- 1 1/8" Die-cast metal security shield
- 0.58" Wall thickness
- 5/8" Diameter
- Blocks wrench access
- Protects F connectors on traps, ground blocks and converters from tampering



**200-966** 1-1/8" Screw-On Security Shield  
**200-968** 1-1/8" Slip-On Security Shield

### Cable Strain-Relief Boot

- Slip-On insulated strain-relief covers, protects and supports cable to prevent breakage
- UV Inhibitor™ ultraviolet-ray resistant



**200-972** RG59 Strain Relief Boot, BK

### Weather Boot

- Tapered inner-diameter weather boot
- Suitable for regular-tri-quad shield series 6 and series 59 coaxial cable
- Flexible rubber construction
- UV Inhibitor™ ultraviolet-ray resistant



**200-976** 2" RG59/6 Weather Boot Ribbed, BK



### Weather Boot

- Tapered inner-diameter weather boot
- Suitable for regular-tri-quad shield series 6 and series 59 coaxial cable
- Flexible rubber construction
- UV Inhibitor™ ultraviolet-ray resistant



**200-975** RG59/6 UV Weather Boot Long, BK  
**200-977** RG59/6 Weather Boot Long, BK



### Feed-Through Bushing

- Seals wall openings and protects cable
- Impact-resistant ABS plastic construction
- UV inhibitor™ protects bushing from ultraviolet ray damage



**200-984** RG6 Feed Through Bushing with Ground and Messenger Knock Outs, BK / CL / IV



### Feed-Through Bushings

- Seals wall openings and protects cable
- Impact-resistant ABS plastic construction
- UV inhibitor™ protects bushing from ultraviolet ray damage



**200-985** RG6 Dual Feed Through Bushing with Ground and Messenger Knock Outs, BK / CL / WH / IV



### Feed-Through Bushing

- Seals wall openings and protects cable
- Impact-resistant ABS plastic construction
- UV inhibitor™ protects bushing from ultraviolet ray damage



**200-986** RG6 Feed Through Bushing, BK / CL  
**200-986-10** 10ct RG6 Feed Through Bushing, BK



### Feed-Through Bushing

- Seals wall openings and protects cable
- Impact-resistant ABS plastic construction
- UV inhibitor™ protects bushing from ultraviolet ray damage



**200-988** RG6 Dual Feed Through Bushing, BK / CL  
**200-988-10** 10ct RG6 Dual Feed Through Bushing, BK / IV



### Self-Adhesive Tape

- 10' Self-adhesive tape for insulating and weatherproofing
- Seals to itself permanently
- 3 3/4" Wide – 118 mil thick



**221-410** Synthetic Rubber Sealing Tape 3-3/4" x 10'

### PVC Electrical Tape

- Weather-resistant PVC electrical tape - 3/4" wide



**400-904** 60' Electrical Tape Non-UL, BK

### PVC Electrical Tape

- Weather-resistant PVC electrical tape - 3/4" wide



**400-905** 60' Electrical Tape UL, BK / BL / GR / WH





### Audio-Video RF Modulator



- Audio-video NTSC RF modulator
- Connects RCA and s-video inputs from DVD players, camcorders, video game system consoles or any A/V equipment to an F-type output
- Suitable for older TV sets without RCA or s-video inputs
- RF output channels 3&4
- Power source 120VAC 60Hz 4.5W
- Dimensions: 5 7/8"(W) x 1 7/8"(H) x 3"(D)



**203-101** Ch 3/4 RF Modulator

### Coaxial Switch

- Switches between 2 input sources
- Hardware and adhesive pad included
- 75Ω inputs – 7Ω output
- Bandwidth 5-900MHz UHF-VHF-FM



**200-310** 2-Way Coaxial A/B Switch

### Coaxial Switch

- Switches between 2 input sources
- Hardware and adhesive pad included
- 75Ω inputs – 7Ω output
- Bandwidth 5-900MHz UHF-VHF-FM
- 90dB High-isolation



**200-315** 2-Way Coaxial A/B Switch

### TV/PC Converter/Tuner



- Sends TV programs, videos, DVDs and video games to PC monitor
- Converts composite video or s-video signal into VGA signal
- Enables plug-and-play without additional software or video card
- Convenient front panel controls
- Full-function remote control
- Includes RCA and s-video jacks
- Supports NTSC and PAL video standards
- Includes converter stand, batteries, AC/DC adapter and user manual
- Unit: 6"(W) x 1"(H) x 4"(D)
- Remote: 2 1/2"(W) x 5"(H) x 1"(D)



**203-250** TV to PC Monitor Converter & NTSC Tuner

### TV/PC Converter

- Displays PC applications on TV monitor
- Converts VGA signal into composite video or s-video signal
- Computer's USB port powers converter at 5VDC, 500mA
- Enables plug-and-play without additional software
- Special circuitry reduces video flickering
- Convenient front panel controls
- Full-function remote control
- Supports NTSC and PAL video standards
- Includes VGA and video cables, USB cable, batteries and user manual
- Unit 6 1/2"(W) x 1 1/2"(H) x 4 1/2"(D)
- Remote 2 1/2"(W) x 5"(H) x 1"(D)



**203-270** PC to TV Converter (NTSC)

### Digital HDMI® Repeater

- Extends HDTV source's reach up to 150'
- Designed for HDMI-compatible digital video recorders, DVD players and recorders, cable/satellite digital set-tops, HDTV sets and high-resolution monitors
- Maintains/equalizes digital video and audio quality over long stretches of HDMI cables
- Supports DDWG standards for HDMI-compliant monitors
- HDCP compliant, FCC and CE certified
- Includes 5VDC power adapter for longer length applications and user's manual
- Dimensions: 2.6"(W) x 0.9"(H) x 2.6"(D)



**516-011** HDMI Repeater w/ Power Supply

### Digital HDMI® Switch

- Suitable for HDMI-compatible digital video recorders, cable/satellite digital set-tops and DVD players
- Switches between different HDMI sources for display on an HDTV or monitor
- Remote control or front panel enables selection from multiple HDMI devices
- Supports DDWG standards for HDMI-compliant monitors
- HDCP compliant – FCC and CE certified
- Includes remote control, 9VDC power adapter and user's manual
- Dimensions: 7"(W) x 1"(H) x 2.9"(D)



**516-021** HDMI 2X1 Switch w/Remote

**516-024** HDMI 4X1 Switch w/Remote

**Contact your  
Stereon Representative  
for more information**

**Phone: (800) 266-3333**



## MOUNTS

### Mounting Brackets

#### Quick Pipe Adapter

- 1 5/8" DSS easy-install pipe adapter
- 8" Length suitable for 2 7/8" to 4 1/2" ID pipes
- Adapts C-band and prime star pipes for 18" dishes
- Powder-coated durable finish



**200-904** Satellite Dish Quick Pipe Adapter

#### Quick Pipe Adapter

- Penetration-free attachment ensures no damage to structures
- Provides reliable mounting on pipes, mast or secure flat structures.
- Steel construction
- Powder-coated durable finish
- SAE Grade 5 hardware
- 3/8" Slot width



**200-905** Satellite Dish Mount Quick Pipe Adapter

#### Satellite Dish Mount

- Bracket allows mounting of satellite dish to the eave of a building
- Increases dish mounting location options
- Eliminates roof penetration
- Steel construction
- Powder-coated durable finish
- SAE Grade 5 Hardware



**221-355** Fascia Mount Plate

#### Satellite Antenna Tripod

- Satellite antenna tripod tower base
- Swing-up easy installation
- Mounts DBS dish safely and securely
- Zinc-plated 16-gauge tubular steel
- Legs OD 1 1/4"
- Mast OD 1 5/8"
- 31 1/4"(W) x 45 1/2"(H) x 25 5/8"(D)



**221-120** 3' Antenna Tripod Kit

#### Satellite Dish Mount

- J" Pipe mount
- Steel construction
- 36" Long
- Electro-coated for maximum protection



**221-352** Satellite Dish J-Pipe Mount

#### Satellite Dish Mount

- Wall mount antenna brackets
- W-Type wall mount brackets
- 4" Clearance from wall
- Attaches antenna mast to side of building
- Set of two brackets
- Includes mounting hardware



**221-353** Satellite Dish Wall Mount Brackets

#### Satellite Dish Mount

- Penetration-free attachment ensures no damage to structures
- Clamps directly to roof overhangs, joists, patio/balcony railings or fences
- Suitable for dishes up to 24"
- Simple removal
- Steel construction
- Powder-coated durable finish
- SAE Grade 5 Hardware

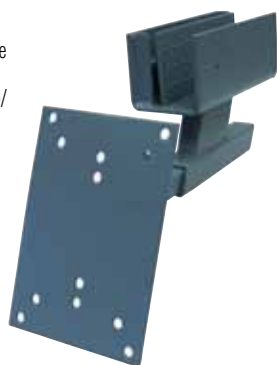

**221-360** Clamp-On Dish Mount - Small

#### Satellite Dish Mount

- Penetration-free attachment ensures no damage to structures
- Clamps directly to roof overhangs, joists, patio/balcony railings or fences
- Suitable for 18" - 36" dishes
- Simple removal
- Steel construction
- Powder-coated durable finish
- SAE Grade 5 Hardware



**221-365** Clamp-On Dish Mount - Large





### Non-Penetrating Roof Mount

- Non-penetrating roof mount
- Mounts DBS satellite dish safely and securely on rooftop
- Ideal for dish antennas with foot mounts
- Ensures smooth and fast antenna mounting
- Accepts standard-size concrete building blocks as anchors
- Sturdy steel construction
- Includes foot-mounting bolts, nuts, washers
- 37 1/2"(L) x 24 1/2"(D)



**221-110** Non-Penetrating Roof Mount

### Personal Audio Y-Cable

- Transfers audio to and from a personal audio player and other devices
- Suitable for portable CD players, MP3/MP4 players, PC sound cards and other devices
- Fully molded nickel-plated connectors



**252-001** 6" 3.5mm Plug to 2-3.5mm Jack Y Stereo Audio Patch Cord, WH  
**252-002** 2' 3.5mm Plug to 2-3.5mm Jack Y Stereo Audio Patch Cord, WH  
**252-006** 6' 3.5mm Plug to 2-3.5mm Jack Y Stereo Audio Patch Cord, WH

### Personal Audio Y-Cable

- Transfers audio to and from a personal audio player and other devices
- Suitable for portable CD players, MP3/MP4 players, PC sound cards and other devices
- Fully molded nickel-plated connectors



**252-051** 6" 3.5mm Stereo Plug to 2-RCA Plug Y Audio Patch Cord, WH  
**252-052** 2' 3.5mm Stereo Plug to 2-RCA Plug Y Audio Patch Cord, WH  
**252-056** 6' 3.5mm Stereo Plug to 2-RCA Plug Y Audio Patch Cord, WH  
**252-062** 12' 3.5mm Stereo Plug to 2-RCA Plug Y Audio Patch Cord, WH

### Y-Cable Audio Adapter

- Shielded Y-cables
- Black PVC jacket
- Fully molded nickel-plated RCA plugs



**255-010** 6" RCA Plug to 2-RCA Jack Y Audio Patch Cord, BK / RD / WH  
**255-010RD** 6" RCA Plug to 2-RCA Jack Y Audio Patch Cord, RD / RD / RD  
**255-010WH** 6" RCA Plug to 2-RCA Jack Y Audio Patch Cord, WH / WH / WH

### Y-Cable Audio Adapter

- Shielded Y-cables
- Black PVC jacket
- Fully molded nickel-plated RCA plugs
- Color-coded red-white to black



**255-020** 6" RCA Plug to 2-RCA Plug Y Audio Patch Cord

### Y-Cable Audio Adapter

- Shielded Y-cables
- Black PVC jacket
- Fully molded nickel-plated RCA plugs
- Color-coded red-white to black



**255-025** 6" RCA Jack to 2-RCA Plug Y Audio Patch Cord

### Y-Cable Audio Adapter

- Shielded Y-cables
- Black PVC jacket
- Fully molded nickel-plated RCA plugs
- Color-coded red-white to black



**255-036** 6" 3.5mm Stereo Jack to 2-RCA Plug Y Audio Patch Cord



### Y-Cable Audio Adapter

- Shielded Y-cables
- Black PVC jacket
- Fully molded nickel-plated RCA plugs
- Color-coded red-white to black



**255-037** 6" 3.5mm Stereo Plug to 2-RCA Plug Y Audio Patch Cord

### Y-Cable Audio Adapter

- Shielded Y-cables
- Black PVC jacket
- Fully molded nickel-plated RCA plugs
- Color-coded red-white to black



**255-038** 6" 3.5mm Stereo Plug to 2-RCA Jack Y Audio Patch Cord

### Y-Cable Audio Adapter

- Shielded Y-cables
- Black PVC jacket
- Fully molded nickel-plated RCA plugs
- Color-coded red-white to black



**255-039** 6" 3.5mm Stereo Jack to 2-3.5mm Stereo Plug Y Audio Patch Cord

### Y-Cable Audio Adapter

- Shielded Y-cables
- Black PVC jacket
- Fully molded nickel-plated RCA plugs
- Color-coded red-white to black



**255-042** 6" 3.5mm Stereo Plug to 2-3.5mm Stereo Jack Y Audio Patch Cord

### Y-Cable Audio Adapter

- Shielded Y-cables
- Black PVC jacket
- Fully molded nickel-plated RCA plugs
- Color-coded red-white to black



**255-045** 6" 3.5mm Stereo Plug to 2-RCA Plug Y Audio Patch Cord  
**255-047** 12" 3.5mm Stereo Plug to 2-RCA Plug Y Audio Patch Cord

### Y-Cable Audio Adapter

- Shielded Y-cables
- Black PVC jacket
- Fully molded nickel-plated RCA plugs
- Color-coded red-white to black



**255-048** 6" 3.5mm Stereo Plug to 2-RCA Jack Y Audio Patch Cord

### Y-Cable Audio Adapter

- Shielded Y-cables
- Black PVC jacket
- Fully molded nickel-plated RCA plugs
- Color-coded red-white to black



**255-059** 6" 1/4 Mono Plug to 2-RCA Jack Y Audio Patch Cord

### Home Theater Y-Cable

- Home Theater Y-cable audio interconnects
- Unparalleled quality and top-line performance for home theater audio equipment
- Ultra flexible rubberized PVC jacket
- Color-coded
- Fully molded construction



**254-045** 6" 3.5mm Stereo Plug to 2-RCA Plug Y Audio Patch Cord, BL



### Home Theater Y-Cable

- Home theater Y-cable audio interconnects
- Unparalleled quality and top-line performance for home theater audio equipment
- Ultra flexible rubberized PVC jacket
- Color-coded – fully molded construction



**254-206** 6" RCA Plug to 2-RCA Jack Y Audio Patch Cord, IV

### Home Theater Y-Cable

- Home theater Y-cable audio interconnects
- Unparalleled quality and top-line performance for home theater audio equipment
- Ultra flexible rubberized PVC jacket
- Color-coded – fully molded construction



**254-207** 6" RCA Jack to 2-RCA Plug Y Audio Patch Cord, IV

### RCA Audio Patch Cord

- Shielded RCA patch cord
- PVC jacket
- Fully molded construction
- High-retention RCA plugs



**255-105** 10' RCA Extension Patch Cord

### RCA Audio Patch Cord

- Shielded RCA patch cord
- PVC jacket
- Fully molded construction
- High-retention RCA plugs



**255-110** 6' RCA Audio Patch Cord  
**255-115** 10' RCA Audio Patch Cord  
**255-117** 25' RCA Audio Patch Cord

### RCA Audio Patch Cord

- Shielded RCA patch cord
- PVC jacket
- Fully molded construction
- High-retention RCA plugs



**255-120** 3' 2-RCA Stereo Audio Patch Cord  
**255-125** 6' 2-RCA Stereo Audio Patch Cord  
**255-130** 12' 2-RCA Stereo Audio Patch Cord  
**255-134** 20' 2-RCA Stereo Audio Patch Cord  
**255-135** 25' 2-RCA Stereo Audio Patch Cord  
**255-138** 50' 2-RCA Stereo Audio Patch Cord

### RCA Audio Patch Cord

- Shielded RCA patch cord
- PVC jacket
- Fully molded construction
- High-retention RCA plugs



**255-121** 3' 2-RCA Stereo Audio Patch Cord-Gold  
**255-126** 6' 2-RCA Stereo Audio Patch Cord-Gold  
**255-131** 12' 2-RCA Stereo Audio Patch Cord-Gold  
**255-136** 25' 2-RCA Stereo Audio Patch Cord-Gold

### RCA Audio Patch Cord

- Shielded RCA patch cord
- PVC jacket
- Fully molded construction
- High-retention RCA plugs



**255-140** 6' 2-RCA to 2-RCA Piggyback Audio Patch Cord  
**255-145** 12' 2-RCA to 2-RCA Piggyback Audio Patch Cord

### RCA Audio Patch Cord

- Shielded RCA patch cord
- PVC jacket
- Fully molded construction
- High-retention RCA plugs



**255-150** 6' 4-RCA to 4-RCA Audio Patch Cord Black



### RCA Audio Patch Cord

- Shielded RCA patch cord
- PVC jacket
- Fully molded construction
- High-retention RCA plugs



**255-175** 6' 2-RCA Plug to 2-RCA Jack Audio Patch Cord

### RCA Premium Patch Cord

- Dual RCA premium patch cord
- Black PVC jacket
- High-retention gold RCA plugs
- Color-coded red-white to red-white



**255-220** 3' 2-RCA Premium Audio Patch Cord  
**255-225** 6' 2-RCA Premium Audio Patch Cord  
**255-230** 12' 2-RCA Premium Audio Patch Cord  
**255-235** 18' 2-RCA Premium Audio Patch Cord  
**255-240** 25' 2-RCA Premium Audio Patch Cord

### Audio Patch Cord

- Suitable for general audio applications
- Fully molded construction



**252-601** 1.5' 2.5mm Stereo Audio Patch Cord  
**252-603** 3' 2.5mm Stereo Audio Patch Cord  
**252-606** 6' 2.5mm Stereo Audio Patch Cord  
**252-612** 12' 2.5mm Stereo Audio Patch Cord

### Audio Patch Cord

- Suitable for general audio applications
- Fully molded construction



**252-651** 1.5' 2.5mm Stereo Audio Patch Cord Extension  
**252-653** 3' 2.5mm Stereo Audio Patch Cord Extension  
**252-656** 6' 2.5mm Stereo Audio Patch Cord Extension  
**252-662** 12' 2.5mm Stereo Audio Patch Cord Extension

### Audio Patch Cord

- Suitable for general audio applications
- Fully molded construction



**252-682** 6' 3.5mm Stereo Jack to 2.5mm Stereo Plug Audio Patch Cord

### Audio Patch Cord

- Suitable for general audio applications
- Fully molded construction



**252-684** 6' 3.5mm Stereo Plug to 2.5mm Stereo Plug Audio Patch Cord

### Audio Patch Cord

- Suitable for general audio applications
- Fully molded construction



**255-155** 2' 3.5mm Mono Patch Cord  
**255-160** 6' 3.5mm Mono Patch Cord  
**255-165** 10' 3.5mm Mono Patch Cord

### Audio Patch Cord

- Suitable for general audio applications
- Fully molded construction



**255-170** 6' 3.5mm Mono Plug to RCA Plug Audio Patch Cord



### Audio Patch Cord

- Suitable for general audio applications
- Fully molded construction



**255-185** 10' 3.5mm Stereo Coiled Patch Cord Extension  
**255-187** 25' 3.5mm Stereo Coiled Patch Cord Extension

### Audio Patch Cord

- Suitable for general audio applications
- Fully molded construction



**255-190** 25' 1/4" Mono Coiled Patch Cord Extension

### Audio Patch Cord

- Suitable for general audio applications
- Fully molded construction



**255-195** 25' 1/4" Stereo Coiled Patch Cord Extension

### Audio Patch Cord

- Suitable for general audio applications
- Fully molded construction



**255-255** 2' 3.5mm Stereo Patch Cord  
**255-258** 6' 3.5mm Stereo Patch Cord  
**255-262** 12' 3.5mm Stereo Patch Cord

### Audio Patch Cord

- Suitable for general audio applications
- Fully molded construction



**255-264** 25' 3.5mm Stereo Patch Cord  
**255-272** 50' 3.5mm Stereo Patch Cord

### Audio Patch Cord

- Suitable for general audio applications
- Fully molded construction



**255-265** 6' 3.5mm Stereo Patch Cord Extension  
**255-268** 12' 3.5mm Stereo Patch Cord Extension  
**255-269** 25' 3.5mm Stereo Patch Cord Extension  
**255-274** 50' 3.5mm Stereo Patch Cord Extension

### Camcorder Cable

- Premium camcorder cables
- High-performance video and audio playback
- Connect to mini-plug-compatible camcorders
- 3.5mm AV mini-plug to three RCA plugs
- Color-coded high-retention RCA plugs



**255-217** 3' 3.5mm Plug to 3-RCA Plug Camcorder Patch Cord  
**255-219** 6' 3.5mm Plug to 3-RCA Plug Camcorder Patch Cord

### Microphone Cable

- Professional quality microphone cable
- Suitable for microphones, musical instruments and home entertainment systems
- Black flexible rubber jacket
- Low-loss heavy gauge cable



**255-290** 20' 1/4" Mono Plug to XLR Jack Microphone Cable



## CABLES Audio

### Microphone Cable

- Professional quality microphone cable
- Suitable for microphones, musical instruments and home entertainment systems
- Black flexible rubber jacket
- Low-loss heavy gauge cable



**255-295** 20' XLR Microphone Extension Cable  
**255-298** 60' XLR Microphone Extension Cable

### Home Theater Cable

- High-definition home theater RCA interconnects
- Unparalleled quality and top-line performance for home theater audio equipment
- Ultra-flexible rubberized PVC jacket
- High-retention RCA plugs
- Color-coded
- Fully molded construction



**254-210BL** 3' 2-RCA Stereo Audio Cable  
**254-215BL** 6' 2-RCA Stereo Audio Cable  
**254-220BL** 12' 2-RCA Stereo Audio Cable  
**254-225BL** 25' 2-RCA Stereo Audio Cable  
**254-230BL** 50' 2-RCA Stereo Audio Cable  
**254-235BL** 75' 2-RCA Stereo Audio Cable  
**254-240BL** 100' 2-RCA Stereo Audio Cable

### Optical Digital Audio Cable

- Suitable for general digital audio applications
- Suitable for CD, MiniDisc, DVD, MP3 applications
- Blue PVC jacket
- Fully molded construction with strain relief



**260-003** 3' Toslink Digital Optical Patch Cord  
**260-006** 6' Toslink Digital Optical Patch Cord  
**260-012** 12' Toslink Digital Optical Patch Cord

### Optical Digital Audio Cable

- Suitable for general digital audio applications
- Suitable for CD, MiniDisc, DVD, MP3 applications
- Blue PVC jacket
- Fully molded construction with strain relief



**260-203** 3' Mini-Plug Digital Optical Patch Cord  
**260-206** 6' Mini-Plug Digital Optical Patch Cord  
**260-212** 12' Mini-Plug Digital Optical Patch Cord

### S/PDIF Digital Audio Cable

- (S/PDIF) Digital audio cables
- Provides superior connections for digital audio equipment
- Fully supports S/PDIF audio file transfer format
- Fully molded construction for increased reliability



**254-006OR** 6' RCA-RCA SPDIF Cable  
**254-012OR** 12' RCA-RCA SPDIF Cable

### S/PDIF Digital Audio Cable

- (S/PDIF) Cables
- Provides superior connections for digital audio equipment
- Fully supports S/PDIF audio file transfer format
- Fully molded construction for increased reliability



**260-306OR** 6' SPDIF Digital Optical Patch Cord

## JRG CUSTOM PRE-ASSEMBLED COAXIAL CABLE JUMPERS

Jumper Shop's professional staff provides design experience for all custom cable assemblies, giving the best value for your dollar. With convenient and pre-terminated cable assemblies, you can reduce on-site labor cost. Our goal is to save you time and money.

Our manufacturing facilities are ready to suit your needs with the capacity to produce over 3 million jumpers in a month. Assemblies are factory tested to ensure high reliability and performance.

We have custom cable assemblies ready for diverse markets. Our cables are used in the satellite, CATV, broadband and consumer electronics industries.

We offer a broad range of coaxial cable assemblies including types F, RCA and BNC and other connections. We also have a multitude of coaxial cables with an array of colors, shielding, dimensions and cable series.

Jumper Shop offers the most versatile packaging including bulk packaging, private labeling and retail packaging.





### F Coaxial Cable

- Suitable for general video applications
- 75Ω Low-loss RG59/U coaxial cable



- 205-000** 1' F-F RG59 Patch Cable, BK
- 205-010** 3' F-F RG59 Patch Cable, BK / WH
- 205-015** 6' F-F RG59 Patch Cable, BK / WH
- 205-018** 9' F-F RG59 Patch Cable, BK
- 205-020** 12' F-F RG59 Patch Cable, BK / WH
- 205-030** 25' F-F RG59 Patch Cable, BK / WH
- 205-035** 50' F-F RG59 Patch Cable, BK / WH
- 205-045** 100' F-F RG59 Patch Cable, BK / WH

### F Coaxial Cable

- Suitable for general video applications
- 75Ω Low-loss RG59/U coaxial cable



- 205-210BK** 3' F-F RG59 Patch Cable-Gold
- 205-215BK** 6' F-F RG59 Patch Cable-Gold
- 205-220BK** 12' F-F RG59 Patch Cable-Gold
- 205-230BK** 25' F-F RG59 Patch Cable-Gold
- 205-233BK** 35' F-F RG59 Patch Cable-Gold

### F-Quick Coaxial Cable

- Suitable for general video applications
- 75Ω Low-loss RG59/U coaxial cable



- 205-110BK** 3' F-F RG59 Quick Connector Patch Cable
- 205-115BK** 6' F-F RG59 Quick Connector Patch Cable
- 205-120BK** 12' F-F RG59 Quick Connector Patch Cable

### F-Quick Coaxial Cable

- Suitable for general video applications
- 75Ω Low-loss RG59/U coaxial cable



- 205-310** 3' F-F RG59 Quick Connector Patch Cable-Gold, BK
- 205-315** 6' F-F RG59 Quick Connector Patch Cable-Gold, BK

### BNC Coaxial Cable

- BNC plug to BNC plug RG59 coaxial cable
- 75Ω and 50Ω
- Nickel-plated connectors
- Black cable



- 205-521** 3' BNC-BNC RG59 Patch Cable
- 205-525** 6' BNC-BNC RG59 Patch Cable
- 205-529** 12' BNC-BNC RG59 Patch Cable
- 205-537** 25' BNC-BNC RG59 Patch Cable
- 205-547** 50' BNC-BNC RG59 Patch Cable

### RCA Coaxial Cable

- 75Ω Low-loss RG59/U coaxial cable
- High-retention RCA connectors
- Black cable



- 206-000** 6' RCA-RCA RG59 Patch Cable
- 206-010** 12' RCA-RCA RG59 Patch Cable
- 206-015** 25' RCA-RCA RG59 Patch Cable
- 206-200** 6' RCA-RCA RG59 Patch Cable-Gold



## CABLES RG6

### High-Grade F Coaxial Cable

- 75Ω RG6/U UL Listed high definition cable
- Suitable for DSS, C/Ku satellite installations
- High-performance 100% fully swept to 3GHz



- 205-410** 3' F-F RG6 Patch Cable UL, BK / WH
- 205-415** 6' F-F RG6 Patch Cable UL, BK / WH
- 205-418** 9' F-F RG6 Patch Cable UL, BK
- 205-420** 12' F-F RG6 Patch Cable UL, BK / WH
- 205-423** 15' F-F RG6 Patch Cable UL, BK
- 205-430** 25' F-F RG6 Patch Cable UL, BK / WH
- 205-435** 50' F-F RG6 Patch Cable UL, BK / WH
- 205-440** 75' F-F RG6 Patch Cable UL, BK / WH
- 205-445** 100' F-F RG6 Patch Cable UL, BK / WH
- 205-450** 150' F-F RG6 Patch Cable UL, BK

### High-Grade F Coaxial Cable

- 75Ω RG6/U UL Listed high definition cable
- Suitable for DSS, C/Ku satellite installations
- High-performance 100% fully swept to 3GHz



- 205-910** 3' F-F RG6 Patch Cable-Gold UL, BK
- 205-915** 6' F-F RG6 Patch Cable-Gold UL, BK
- 205-920** 12' F-F RG6 Patch Cable-Gold UL, BK
- 205-930** 25' F-F RG6 Patch Cable-Gold UL, BK
- 205-940** 75' F-F RG6 Patch Cable-Gold UL, BK
- 205-945** 100' F-F RG6 Patch Cable-Gold UL, BK
- 205-950** 150' F-F RG6 Patch Cable-Gold UL, BK

### High-Grade BNC Cable

- 75Ω RG6/U UL Listed professional BNC cable
- Crimped precision machined zinc-alloy BNC connectors
- Double aluminum foil shield plus 60% copper braid shield



- 205-580** 3' BNC-BNC RG6 Patch Cable UL, BK
- 205-582** 6' BNC-BNC RG6 Patch Cable UL, BK
- 205-586** 12' BNC-BNC RG6 Patch Cable UL, BK
- 205-590** 25' BNC-BNC RG6 Patch Cable UL, BK
- 205-592** 50' BNC-BNC RG6 Patch Cable UL, BK
- 205-596** 100' BNC-BNC RG6 Patch Cable UL, BK

### Weather-Resistant F Cable

- 75Ω RG6/U UL Listed professional F cable
- Suitable for DSS, C/Ku satellite installations
- Crimped precision machined brass F-connectors
- Weatherproof o-ring
- Silicone compound sealed
- High-performance 100% fully swept to 3GHz



- 208-420** 12' F-F RG6 Weatherproof Patch Cable UL, BK / WH
- 208-430** 25' F-F RG6 Weatherproof Patch Cable UL, BK / WH
- 208-435** 50' F-F RG6 Weatherproof Patch Cable UL, BK / WH
- 208-440** 75' F-F RG6 Weatherproof Patch Cable UL, BK
- 208-445** 100' F-F RG6 Weatherproof Patch Cable UL, BK / WH
- 208-450** 150' F-F RG6 Weatherproof Patch Cable UL, BK / WH





### RCA Video Patch Cord

- Low-loss fully shielded RCA dubbing cable
- Applications include home theater, DSS receivers, S-video VCRs, camcorders and DVD players
- 1 RG59-Video + shielded audio conductor
- Fully molded color-coded gold RCA connectors



**206-250** 6' 2-RCA Composite Audio/Video Cable  
**206-252** 12' 2-RCA Composite Audio/Video Cable

### RCA Video Patch Cord

- Low-loss fully shielded RCA dubbing cable
- Applications include home theater, DSS receivers, s-video VCRs, camcorders and DVD players
- 1 RG59-video 2x shielded audio conductor
- Fully molded color-coded gold RCA connectors



**206-273** 3' 3-RCA Composite Audio/Video Cable  
**206-275** 6' 3-RCA Composite Audio/Video Cable  
**206-277** 12' 3-RCA Composite Audio/Video Cable  
**206-282** 18' 3-RCA Composite Audio/Video Cable  
**206-284** 25' 3-RCA Composite Audio/Video Cable  
**206-288** 50' 3-RCA Composite Audio/Video Cable  
**206-289** 60' 3-RCA Composite Audio/Video Cable

### Home Theater Cable

- High-definition home theater RCA interconnects
- Unparalleled quality and top-line performance for home theater audio equipment
- Ultra-flexible rubberized PVC jacket
- High-retention RCA plugs
- Color-coded
- Fully molded construction



**254-110BL** 3' 1-RCA Audio/Video Cable  
**254-115BL** 6' 1-RCA Audio/Video Cable  
**254-120BL** 12' 1-RCA Audio/Video Cable  
**254-125BL** 25' 1-RCA Audio/Video Cable  
**254-130BL** 50' 1-RCA Audio/Video Cable  
**254-135BL** 75' 1-RCA Audio/Video Cable  
**254-140BL** 100' 1-RCA Audio/Video Cable

### Home Theater Cable

- High-definition home theater RCA interconnects
- Unparalleled quality and top-line performance for home theater audio equipment
- Ultra-flexible rubberized PVC jacket
- Color-coded (RD, WH, YL)
- Fully molded construction



**254-310BL** 3' 3-RCA Audio/Video Cable  
**254-315BL** 6' 3-RCA Audio/Video Cable  
**254-320BL** 12' 3-RCA Audio/Video Cable  
**254-325BL** 25' 3-RCA Audio/Video Cable  
**254-330BL** 50' 3-RCA Audio/Video Cable  
**254-335BL** 75' 3-RCA Audio/Video Cable  
**254-340BL** 100' 3-RCA Audio/Video Cable

### Economy Video Patch Cord

- Low-loss fully shielded RCA dubbing cable
- Applications Include home theater, DSS receivers, S-video VCRs, camcorders and DVD players
- Fully Molded color-coded Nickel RCA connectors



**206-276** 6' 3-RCA Composite Audio/Video Cable  
**206-278** 12' 3-RCA Composite Audio/Video Cable

### S-Video Audio/Video Patch Cord

- Low-loss fully shielded S-video cable
- Applications include home theater, DSS receivers, VCRs, DVRs/PVRs, camcorders and DVD players
- 4-Contact mini-DIN plug S-video cable and dual-RCA plug stereo cables
- Fully molded color-coded high-retention RCA connectors
- Flexible black PVC jacket



**206-295** 6' S-Video+2-RCA Audio/Video Cable  
**206-297** 12' S-Video+2-RCA Audio/Video Cable

### Optical S-Video Patch Cord

- High-grade S-video optical patch cord
- Fully molded construction
- Gold-plated S-video connectors



**253-003BL** 3' S-Video + Toslink Digital Optical Patch Cord  
**253-006BL** 6' S-Video + Toslink Digital Optical Patch Cord  
**253-012BL** 12' S-Video + Toslink Digital Optical Patch Cord

### S-Video Cable

- Low-loss fully-shielded S-video cables
- 4-Contact mini-DIN plug to plug
- Gold-plated
- Fully molded
- Flexible black PVC jacket



**255-199** 3' S-Video Patch Cord  
**255-200** 6' S-Video Patch Cord  
**255-202** 12' S-Video Patch Cord  
**255-206** 25' S-Video Patch Cord  
**255-208** 50' S-Video Patch Cord  
**255-209** 75' S-Video Patch Cord  
**255-211** 100' S-Video Patch Cord



### Component Optical Cable

- Component-video optical-audio cable
- Provides high-definition A/V signal transfer between DVD Players and high-End TVs or monitors for optimum picture resolution and color
- High-purity wide-band audio transmission
- Ultra-flex satin-ivory rubber 6.0mm OD PVC jacket
- Flat-ribbon cable configuration with ultra-flex satin-ivory jacket
- High-retention RCA connectors
- Color-coded –fully molded construction



**253-103IV** 3' 3-RCA+Toslink Component Audio/Video Cable  
**253-106IV** 3' 3-RCA+Toslink Component Audio/Video Cable  
**253-112IV** 3' 3-RCA+Toslink Component Audio/Video Cable

### Component Video Mini Cable

- Component video RCA mini interconnects
- Provide high-definition video signal transfer between DVD players and high-end TVs or monitors
- Miniature size for use in limited space environments
- Ultra-flex satin-ivory rubber PVC jacket
- High-retention RCA connectors
- Color-coded – fully molded construction



**257-606** 6' 5-RCA Component Audio/Video Cable, BK / IV  
**257-612** 12' 5-RCA Component Audio/Video Cable, BK

### Component Video Cable

- Component video RCA interconnects
- Provides high-definition video signal transfer between DVD players and high-end TVs or monitors for optimum picture resolution and color
- Flat-ribbon cable configuration
- High-retention RCA connectors
- Ultra-flex satin-ivory rubber 6.0mm OD PVC jacket
- Color-coded – fully molded construction



**254-500IV** 100' 3-RCA Component Video Cable  
**254-503IV** 3' 3-RCA Component Video Cable  
**254-506IV** 6' 3-RCA Component Video Cable  
**254-512IV** 12' 3-RCA Component Video Cable  
**254-525IV** 25' 3-RCA Component Video Cable  
**254-550IV** 50' 3-RCA Component Video Cable  
**254-575IV** 75' 3-RCA Component Video Cable

### Component Video Cable

- Component video RCA interconnects
- Provides high-definition video signal transfer between DVD players and high-end TVs or monitors for optimum picture resolution and color
- Flat-ribbon cable configuration
- Ultra-flex satin-ivory rubber 6.0mm OD PVC jacket
- High-retention RCA connectors-color-coded



**254-600IV** 100' 5-RCA Component Audio/Video Cable  
**254-603IV** 3' 5-RCA Component Audio/Video Cable  
**254-606IV** 6' 5-RCA Component Audio/Video Cable  
**254-612IV** 12' 5-RCA Component Audio/Video Cable  
**254-625IV** 25' 5-RCA Component Audio/Video Cable  
**254-650IV** 50' 5-RCA Component Audio/Video Cable  
**254-675IV** 75' 5-RCA Component Audio/Video Cable

### HDTV Component Cable

- HDTV component video cables
- Unparalleled quality and performance for high-definition video and audio equipment
- Fully support (Y, Pr, Pb), (Y, Cr, Cb) and RGB high resolution standards
- Bundled cable configuration
- Ultra-flex satin-ivory rubber jacket
- High-retention connectors
- Color-coded – fully molded construction



**254-406IV** 6' 3-BNC Component Video Cable  
**254-412IV** 12' 3-BNC Component Video Cable  
**254-425IV** 25' 3-BNC Component Video Cable

### HDTV Component Cable

- HDTV component video cables
- Unparalleled quality and performance for high-definition video and audio equipment
- Fully support (Y, Pr, Pb), (Y, Cr, Cb) and RGB high resolution standards
- Bundled cable configuration
- Ultra-flex satin-ivory rubber jacket
- High-retention connectors
- Color-coded – fully molded construction



**254-706IV** 6' 3RCA to 3BNC Component Video Cable  
**254-712IV** 12' 3RCA to 3BNC Component Video Cable  
**254-725IV** 25' 3RCA to 3BNC Component Video Cable

### SVGA Component Cable

- SVGA RGB component video cable
- Fully supports RGB high-resolution standards
- Bundled cable configuration
- Ultra-flex satin-ivory rubber PVC jacket
- Gold-plated high-retention connectors
- Color-coded, fully molded construction
- Does not work for connecting a computer to a home TV



**253-506IV** 6' VGA-3RCA RGB Component Video Cable  
**253-512IV** 12' VGA-3RCA RGB Component Video Cable  
**253-525IV** 25' VGA-3RCA RGB Component Video Cable  
**253-550IV** 50' VGA-3RCA RGB Component Video Cable

### SVGA Component Cable

- SVGA RGB component video cable
- Fully supports RGB high-resolution standards
- Bundled cable configuration
- Ultra-flex satin-ivory rubber PVC jacket
- Gold-plated high-retention connectors
- Color-coded, fully molded construction
- Does not work for connecting a computer to a home TV

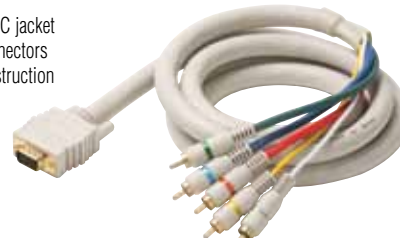

**253-606IV** 6' VGA-5RCA RGB H/V Component Video Cable  
**253-612IV** 12' VGA-5RCA RGB H/V Component Video Cable  
**253-625IV** 25' VGA-5RCA RGB H/V Component Video Cable



### SVGA Component Cable

- SVGA RGB component video cable
- Fully supports RGB high-resolution standards
- Bundled cable configuration
- Ultra-flex satin-ivory rubber PVC jacket
- Gold-plated high-retention connectors
- Color-coded, fully molded construction
- Does not work for connecting a computer to a home TV



- 253-806IV** 6' VGA-5BNC RGB H/V Component Video Cable
- 253-812IV** 12' VGA-5BNC RGB H/V Component Video Cable
- 253-825IV** 25' VGA-5BNC RGB H/V Component Video Cable

### SVGA + 3.5mm Cable

- Carries video and audio conveniently through one cable
- Connector 1: One DE15HD male
- Connector 2: One DE15HD male and one 3.5mm male



- 253-203BK** 3' SVGA DE15HD + 3.5MM Stereo M/M Monitor/Audio Cable
- 253-206BK** 6' SVGA DE15HD + 3.5MM Stereo M/M Monitor/Audio Cable
- 253-212BK** 12' SVGA DE15HD + 3.5MM Stereo M/M Monitor/Audio Cable
- 253-225BK** 25' SVGA DE15HD + 3.5MM Stereo M/M Monitor/Audio Cable
- 253-250BK** 50' SVGA DE15HD + 3.5MM Stereo M/M Monitor/Audio Cable
- 253-200BK** 100' SVGA DE15HD + 3.5MM Stereo M/M Monitor/Audio Cable

### VGA HD15 Cable

- Suitable for VGA/SVGA computer monitors, data projectors and other video displays
- Transfers analog video signals and connects to 15-Pin HD15 S/VGA jacks
- Fully molded construction with ferrites
- Super flexible satin black PVC jacket



- 253-300BK** 100' SVGA HD15 Cable (M/M)
- 253-303BK** 3' SVGA HD15 Cable (M/M)
- 253-306BK** 6' SVGA HD15 Cable (M/M)
- 253-310BK** 10' SVGA HD15 Cable (M/M)
- 253-315BK** 15' SVGA HD15 Cable (M/M)
- 253-325BK** 25' SVGA HD15 Cable (M/M)
- 253-350BK** 50' SVGA HD15 Cable (M/M)
- 253-375BK** 75' SVGA HD15 Cable (M/M)

### DVI-D Digital Interface Cable

- Installs easily on any DVI-D socket found on data projectors, plasma displays, digital TVs and set-top boxes
- Hot swappable
- Dual link (2048 x 1536)
- Super-flexible clack PVC jacket
- Fully molded construction
- Easy-grip captured screws
- UL Listed



- 506-956** 6' DVI-D Dual Link Patch Cable
- 506-960** 10' DVI-D Dual Link Patch Cable
- 506-962** 12' DVI-D Dual Link Patch Cable

### DVI-D Digital Interface Cable

- Installs easily on any DVI-D socket found on data projectors, plasma displays, digital TVs and set-top boxes
- Hot swappable
- Single link (1920 x 1080)
- Super-flexible black PVC jacket
- Fully molded construction
- Easy-grip captured screws
- UL Listed



- 506-906** 6' DVI-D Single Link Patch Cable
- 506-910** 10' DVI-D Single Link Patch Cable
- 506-912** 12' DVI-D Single Link Patch Cable

### DVI-A to VGA HD15 Cable

- Excellent for data projectors, flat-panel displays, digital TV sets and displays
- Provides clear analog video signal transport between VGA/SVGA and DVI-A Devices
- Fully molded construction
- Satin black PVC jacket and overmold



- 516-706BK** 6' DVI-A to SVGA DE15HD Monitor Cable
- 516-710BK** 10' DVI-A to SVGA DE15HD Monitor Cable
- 516-715BK** 15' DVI-A to SVGA DE15HD Monitor Cable

### HDMI® to DVI-D Cable

- HDMI to DVI-D (Single-Link) cables
- Precision manufactured fully molded construction
- Super-flexible satin black PVC jacket

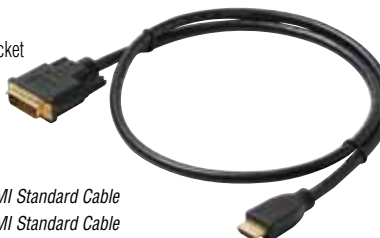

- 516-903BK** 3' DVI-D to HDMI Standard Cable
- 516-906BK** 6' DVI-D to HDMI Standard Cable
- 516-910BK** 10' DVI-D to HDMI Standard Cable
- 516-912BK** 12' DVI-D to HDMI Standard Cable
- 516-915BK** 15' DVI-D to HDMI Standard Cable
- 516-930BK** 30' DVI-D to HDMI Standard Cable

### HDMI® High-Speed with Ethernet (Category 2)

- Carries high-definition digital video, multi-channel audio plus Ethernet data all in one cable
- Supports resolutions beyond standard 1080p or 1440p
- Future proof for resolutions up to 4k x 2k
- Fully able to support 3D content
- Audio Return Channel eliminates excess cabling between TV and audio receiver

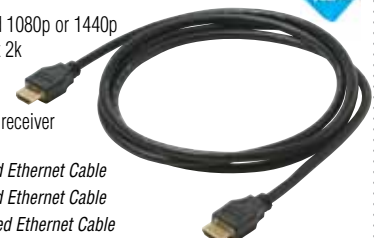

- 517-303BK** 3' HDMI High-Speed Ethernet Cable
- 517-306BK** 6' HDMI High-Speed Ethernet Cable
- 517-310BK** 10' HDMI High-Speed Ethernet Cable
- 517-312BK** 12' HDMI High-Speed Ethernet Cable
- 517-315BK** 15' HDMI High-Speed Ethernet Cable
- 517-330BK** 30' HDMI High-Speed Ethernet Cable
- 517-350BK** 50' HDMI High-Speed Ethernet Cable





## CABLES HDMI® / Coaxial

### HDMI® High-Speed (Category 2)

- High-definition multimedia interface cables
- Compatible with all HDMI-equipped devices
- Carries high-definition digital video and multichannel audio in one cable
- HDMI high-speed (Category 2)
- Super-flexible satin black PVC outer jacket
- Fully molded construction
- UL recognized



- 516-403BK** 3' HDMI C-C (Mini) High-Speed Cable  
**516-406BK** 6' HDMI C-C (Mini) High-Speed Cable  
**516-410BK** 10' HDMI C-C (Mini) High-Speed Cable

### HDMI® High-Speed (Category 2)

- High-definition multimedia interface cables
- Compatible with all HDMI-equipped devices
- Carries high-definition digital video and multichannel audio in one cable
- HDMI high-speed (Category 2)
- Super-flexible satin black PVC outer jacket
- Fully molded construction
- UL recognized



- 516-423BK** 3' HDMI A-C (Std-Mini) High-Speed Cable  
**516-426BK** 6' HDMI A-C (Std-Mini) High-Speed Cable  
**516-430BK** 10' HDMI A-C (Std-Mini) High-Speed Cable

### HDMI® High-Speed (Category 2)

- High-definition multimedia interface cables
- Compatible with all HDMI-equipped devices
- Carries high-definition digital video and multichannel audio in one cable
- HDMI high-speed (Category 2)
- Super-flexible satin black PVC outer jacket
- Fully molded construction
- UL recognized



- 516-503BK** 3' HDMI High-Speed Flat Cable  
**516-506BK** 6' HDMI High-Speed Flat Cable  
**516-510BK** 10' HDMI High-Speed Flat Cable  
**516-512BK** 12' HDMI High-Speed Flat Cable  
**516-515BK** 15' HDMI High-Speed Flat Cable

### HDMI® High-Speed (Category 2)

- High-definition multimedia interface cables
- Compatible with all HDMI-equipped devices
- Carries high-definition digital video and multichannel audio in one cable
- HDMI high-speed (Category 2)
- Super-flexible satin black PVC outer jacket
- Fully molded construction
- UL recognized



- 516-603BK** 3' HDMI High-Speed Cable  
**516-606BK** 6' HDMI High-Speed Cable  
**516-610BK** 10' HDMI High-Speed Cable  
**516-612BK** 12' HDMI High-Speed Cable

### Economy HDMI® Standard (Category 1)

- High-definition multimedia interface cable
- Compatible with all HDMI-equipped devices
- Carries high-definition digital video and multichannel audio in one cable
- HDMI standard (Category 1)
- Fully molded construction
- UL recognized



- 526-203BK** 3' HDMI Standard Economy Cable  
**526-206BK** 6' HDMI Standard Economy Cable  
**526-210BK** 10' HDMI Standard Economy Cable  
**526-212BK** 12' HDMI Standard Economy Cable  
**526-215BK** 15' HDMI Standard Economy Cable  
**526-230BK** 30' HDMI Standard Economy Cable  
**526-250BK** 50' HDMI Standard Economy Cable

### BNC Coaxial Cable

- BNC plug to BNC plug coaxial 50Ω cable
- Nickel-plated connectors



- 205-523** 3' BNC-BNC RG58 Patch Cable  
**205-527** 6' BNC-BNC RG58 Patch Cable  
**205-528** 10' BNC-BNC RG58 Patch Cable  
**205-530** 15' BNC-BNC RG58 Patch Cable  
**205-540** 25' BNC-BNC RG58 Patch Cable  
**205-550** 50' BNC-BNC RG58 Patch Cable  
**205-570** 100' BNC-BNC RG58 Patch Cable

### UHF Coaxial Cable

- UHF plug to UHF plug coaxial cable
- 50Ω Low-loss RG58
- Fully molded
- Nickel-plated connectors



- 205-603** 3' UHF-UHF RG58 Patch Cable, BK  
**205-606** 6' UHF-UHF RG58 Patch Cable, BK  
**205-612** 12' UHF-UHF RG58 Patch Cable, BK

### UHF Coaxial Cable

- UHF plug to UHF plug coaxial cable
- 50Ω Low-loss RG8x-mini
- Fully molded
- Nickel-plated connectors



- 205-700** 100' UHF-UHF Mini-RG8x Patch Cable, BK  
**205-703** 3' UHF-UHF Mini-RG8x Patch Cable, BK  
**205-706** 6' UHF-UHF Mini-RG8x Patch Cable, BK  
**205-712** 12' UHF-UHF Mini-RG8x Patch Cable, BK  
**205-720** 20' UHF-UHF Mini-RG8x Patch Cable, BK  
**205-750** 50' UHF-UHF Mini-RG8x Patch Cable, BK



### 5x1 HDMI® Switch

- Connects multiple HD devices to your HDTV for the ultimate viewing experience
- 5 HDMI inputs, 1 HDMI output
- HDMI High-speed certified and HDCP compliant
- Up to 1080p resolution



**BL-526-037** 5x1 HDMI Switch - 5 HDMI Inputs, 1 HDMI Output

### 3x1 HDMI® Switch

- Connects multiple HD devices to your HDTV for the ultimate viewing experience
- 3 HDMI inputs, 1 HDMI output
- HDMI High-speed certified and HDCP compliant
- Up to 1080p resolution



**BL-526-035** 3x1 HDMI Switch - 3 HDMI Inputs, 1 HDMI Output

### 1x4 HDMI® Splitter

- Takes high-definition video from a single HDMI media source and directs it to 4 separate HDTVs or displays, works up to 50ft away.
- Stream a single HD media source to 4 displays
- Zero signal loss from source to display
- Up to 1080p resolution



**BL-526-041** 1x4 HDMI Splitter - 4 HDMI Inputs, 1 HDMI Output

### 4x2 HDMI® Matrix Switch

- Takes your HDTV to the next level with multiple inputs and outputs to deliver a convenient, vivid and rich viewing experience.
- Cross-switch 4 different HD media sources between 2 different HDTVs or displays
- HDCP compliant
- Dolby® TrueHD and DTS-HD master audio™ support
- Up to 1080p resolution
- Power LED and active-port LED



**BL-526-039** 4x2 HDMI Matrix Switch

### HDMI® Extender

- Extends HD audio/video signal through two Cat5e/6 cables
- Cat5e up to 200ft for 1080p resolution
- Cat6 up to 250ft for 1080p resolution
- HDCP compliant
- Power LED and active signal LED for easy monitoring and troubleshooting



**BL-526-051** HDMI Extender

### HDMI® Repeater w/EQ

- Supports exceptionally long cable runs up to 135ft
- Up to 1080p resolution
- Fully compatible with HDCP compliant components
- Powered directly from most HDMI sources
- 24k Gold-plated connectors for optimum signal transfer



**BL-526-030** HDMI Repeater w/EQ

### 3x1 HDMI® Mini Switch

- Provides additional HDMI connections to your HDTV for the ultimate viewing experience
- 3 HDMI inputs, 1 HDMI output
- HDMI high-speed certified and HDCP compliant
- Up to 1080p resolutions



**BL-526-033** 3x1 HDMI MINI Switch

### HDMI® Cat5e Extender

- HDMI Over dual Cat5e cables in a wall plate solution
- Delivers 1080p full HD video and digital audio for 50'



**526-119** Passive HDMI over Cat5e Wall Plate, IV / WH



### F-F Flat Through Cable

- 8" Flat 75Ω F jumper
- Cable thickness 3/32"
- Eliminates drilling through walls and conveniently runs under or over windows and doors
- Mounting adhesive-taped back

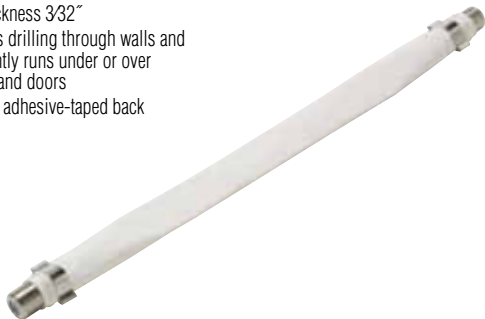

**205-090WH** 8" F-F Flat Coaxial Cable

### LCD/Plasma Screen Cleaning Kit

- Safe and powerful cleaning solution to ensure a clear, vibrant picture
- Removes dust, dirt, and oily fingerprints
- Advanced formula cleans without dripping, streaking, or staining
- Includes a high-tech reusable MicorFiber cloth to clean without scratching



**CL-207-508** LCD/Plasma Screen Cleaning Kit



communications communication

communications **communications** communication

comm







### Telephone Adapter

- Modular telephone adapter
- Cross-wired for telephone
- High-impact ABS plastic
- Gold-plated contacts

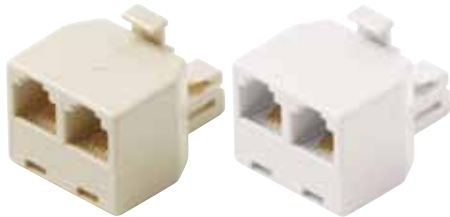

**300-024** Modular 4C Tel T Adapter, IV / WH  
**300-024-10** 10ct Modular 4C Tel T Adapter, IV / WH

### Telephone Adapter

- Modular telephone adapter
- Cross-wired for telephone
- High-impact ABS plastic
- Gold-plated contacts



**300-026** Modular 6C Tel T Adapter, IV

### Telephone Adapter

- Modular telephone adapter
- Straight-wired for data applications
- High-impact ABS plastic
- Gold-plated contacts



**300-028** Modular 8C Data T Adapter, IV

### Telephone Adapter

- Modular telephone adapter
- Cross-wired for telephone
- High-impact ABS plastic
- Gold-plated contacts



**300-034** Modular 4C Tel Coupler, IV / WH  
**300-034-10** 10ct Modular 4C Tel Coupler, IV / WH

### Telephone Adapter

- Modular telephone adapter
- Cross-wired for telephone or straight-wired for data applications
- High-impact ABS plastic
- Gold-plated contacts



**300-036** Modular 6C Voice Coupler, IV  
**300-037** Modular 6C Data Coupler, IV  
**300-039** Modular 8C Data Coupler, IV

### Telephone Adapter

- Modular telephone adapter
- Cross-wired for telephone
- High-impact ABS plastic
- Gold-plated contacts



**300-074** Modular 4C 3-Tel Jack T Adapter, IV

### Telephone Adapter

- Modular telephone adapter
- Cross-wired for telephone
- High-impact ABS plastic
- Gold-plated contacts



**300-124** Modular 4C Triplex Adapter, IV

### Telephone Adapter

- Modular telephone adapter
- Straight wired for data applications
- High-impact ABS plastic
- Gold-plated contacts



**300-324** Modular 4C Triplex Line Splitter/Adapter, IV / WH  
**300-324-10** Modular 4C Triplex Line Splitter/Adapter, IV



**HARDWARE**  
Couplers / Adapters & Modular Connectors

**Telephone Adapter**

- Modular telephone adapter
- Straight-wired for data applications
- High-impact ABS plastic
- Gold-plated contacts



**301-324** Modular 4C Triplex Line Splitter/Adapter UL, IV / WH

**Telephone Extension**

- 6x4 4-Wire 28 AWG ivory extensions plug to jack



**300-142** 15' Modular 5 Outlet Extension, IV

**Category-5E Coupler**

- Category-5E jack-jack couplers
- Joins two RJ45 cords
- Reverse configuration



**310-039** Cat5e In Line Coupler, BK / IV

**In-Line DSL Filter**

- Single-line configuration
- Plug-and-play installation
- Meets ANSI TIE 1.4 7R2 standards for DSL filter compliance

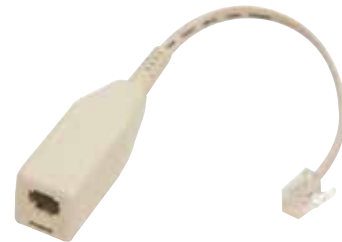

**300-261** Single Line Telephone DSL Filter, IV

**Flat-Cable Modular Plug**

- Terminates 24-26 AWG flat stranded cable
- High-impact clear polycarbonate plugs



- 300-062** 4C 4x4 Handset Plug Plug [A]
- 300-064** 4C 6x4 RJ11 Modular Plug [B]
- 300-066** 6C 6x6 RJ12 Modular Plug [C]
- 300-067** 6C 6x6 RJ12 Modular Plug [D]
- 300-068** 8C 8x8 RJ45 Modular Plug [E]

**Flat-Cable Modular Plug**

- Terminates 24-26 AWG flat stranded cable
- High-impact clear polycarbonate plugs
- UL Version



- 301-064** Modular 6x4 Flat/Stranded RJ11 Plug UL
- 301-064-25** 25ct Modular 6x4 Flat/Stranded RJ11 Plug UL

**Flat-Cable Modular Plug**

- Terminates 24-26 AWG flat stranded cable
- High-impact clear polycarbonate plugs
- UL Version



- 301-066** Modular 6x6 Flat/Stranded RJ12 Plug UL
- 301-068** Modular 8x8 Flat/Stranded RJ45 Plug UL

**Round-Cable Modular Plug**

- Terminates 24-26 AWG round solid cable
- High-impact clear polycarbonate plugs



- 300-164** Modular 6x4 Round/Solid RJ11 Plug
- 300-166** Modular 6x6 Round/Solid RJ12 Plug



### Round-Cable Modular Plug

- Terminates 24-26 AWG round stranded solid cable
- High-impact clear polycarbonate plug



**300-168** Modular 8x8 Round/Solid RJ45 Plug  
**300-168-25** 25ct Modular 8x8 Round/Solid RJ45 Plug  
**300-170** Modular 8x8 Round/Stranded RJ45 Plug

### CAT5E RJ45 Modular Plug

- Suitable for category-5E cable installation
- Terminates 24-28 AWG stranded cable
- High-impact clear polycarbonate plug
- Flame auto-extinguish level UL94V-0



**301-172** Modular 8x8 Round/Stranded RJ45 Cat5e Plug UL  
**301-172-25** 25 ct Modular 8x8 Round/Stranded RJ45 Cat5e Plug UL

### CAT5E RJ45 Modular Plug

- Suitable for category-5E cable installation
- Terminates 24-28 AWG solid cable
- High-impact clear polycarbonate plug
- Flame auto-extinguish level UL94V-0



**301-176** Modular 8x8 Round/Solid 2-Prong RJ45 Cat5e Plug UL

### CAT5E RJ45 Modular Plug

- Suitable for category-5E cable installation
- Terminates 24-28 AWG solid cable
- High-impact clear polycarbonate plug
- Flame auto-extinguish level UL94V-0



**301-178** Modular 8x8 Round/Solid 3-Prong RJ45 Cat5e Plug UL  
**301-178-25** 25 ct Modular 8x8 Round/Solid 3-Prong RJ45 Cat5e Plug UL

### Shielded RJ45 Modular Plug

- Suitable for category-5E cable installations
- Terminates 24-28 AWG solid/stranded cable
- High-impact clear polycarbonate housing
- Flame auto-extinguish level UL94V-0



**301-182** Modular 8x8 Stranded Shielded RJ45 Cat5e Plug UL  
**301-188** Modular 8x8 Solid 3-Prong Shielded RJ45 Cat5e Plug UL

### Fast Media™ CAT6 Modular Plug

- Fast Media™ CAT6 modular plug
- Suitable for all RJ45 connections
- Designed to fit solid CAT6 cable
- Precision manufactured polycarbonate
- Accepts 22-24 AWG solid copper wire



**301-191** Modular 8x8 Round/Solid RJ45 Cat6 Plug UL  
**301-191-25** 25ct Modular 8x8 Round/Solid RJ45 Cat6 Plug UL

### Category-6 Coupler

- Category-6 jack-jack coupler
- Reverse configuration
- Compliant with ANSI / TIA / EIA



**310-040** Cat6 RJ45 Coupler, BK / WH

**Contact your  
Steren Representative  
for more information**

**Phone: (800) 266-3333**



**HARDWARE**  
*Miscellaneous*

**IDC Splicing Connector**

- UR In-line tap IDC connector
- Splices 22-26 AWG wire
- Polypropylene body – red



**300-072** UR 3-Wire Connector Red  
**300-072-25** 25ct UR Wire Connector Red

**IDC Splicing Connector**

- UB In-line tap IDC connector
- Splices 22-26 AWG wire
- Polypropylene body – blue



**300-073** UB Wire Connector Blue

**IDC Splicing Connector**

- UG In-line tap IDC connector
- Splices 22-26 AWG wire
- Polypropylene body – green



**300-075** UG Wire Connector Green

**Bean Wire Connector**

- Crimp-type blue bean wire connector
- Securely splices 19-26 AWG solid copper wire



**300-070** B Wire Connector

**Bean Wire Connector**

- Crimp-type blue bean wire connector
- Securely splices 19-26 AWG solid copper wire



**300-077** B Wire Connector with Gel

**RJ45 Snagless Boot**

- Suitable for round 0.25" dia. UTP cable
- Provides cable-end color ID



**300-080** RJ45 Boot, BK

**Telephone Accessory**

- Miniature suction pick-up coil
- Records or amplifies phone conversations



**300-130** Telephone Pick-up Coil Suction

**Telephone Accessory**

- Handset detangler adapter



**300-251** Handset Cord Detangler



### D-Sub Connector

- RS232 D-subminiature connectors



- 500-009** DE9 9C D-Sub Male Solder
- 500-015** DA15 15C D-Sub Male Solder
- 500-020** DE15 15C HD D-Sub Male Solder
- 500-025** DB25 25C D-Sub Male Solder

### D-Sub Connector

- RS232 D-subminiature connectors



- 500-010** DE9 9C D-Sub Male Crimp
- 500-027** DB25 25C D-Sub Male Crimp

### D-Sub Connector

- RS232 D-subminiature connectors



- 500-109** DE9 9C D-Sub Female Solder
- 500-115** DA15 15C D-Sub Female Solder
- 500-120** DE15 15C HD D-Sub Female Solder
- 500-125** DB25 25C D-Sub Female Solder

### D-Sub Connector

- RS232 D-subminiature connectors



- 500-110** DE9 9C D-Sub Female Crimp
- 500-122** DE15 15C HD D-Sub Female Crimp
- 500-127** DB25 25C D-Sub Female Crimp

### D-Sub Connector

- RS232 D-subminiature connectors



- 500-055** 100ct D-Sub Male Crimp Pin

### D-Sub Connector

- RS232 D-subminiature connectors



- 500-155** 100ct D-Sub Female Crimp Pin

### D-Sub Housing

- RS232 D-subminiature connector covers

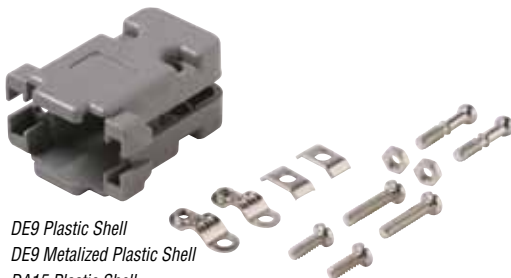

- 500-409** DE9 Plastic Shell
- 500-411** DE9 Metalized Plastic Shell
- 500-415** DA15 Plastic Shell
- 500-425** DB25 Plastic Shell
- 500-427** DB25 Metalized Plastic Shell

### D-Sub Housing

- RS232 D-subminiature connector covers

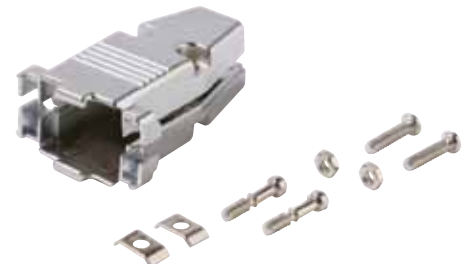

- 500-450** DE9 Metal Shell
- 500-453** DA15 Metal Shell
- 500-455** DB25 Metal Shell



**D-Sub Adapter**

- DE9 9C Mini-coupler

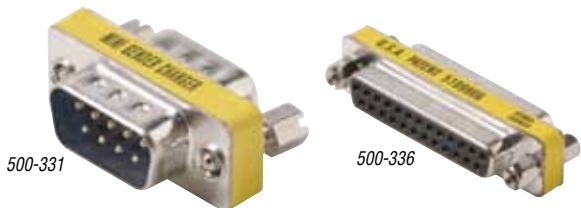

**500-331** DE9 Male-Male Gender Changer  
**500-336** DE9 Female-Female Gender Changer

**D-Sub Modular Adapter**

- Grey plastic hood with long thumbscrews



**504-207** DE9 Male to 6x6 Modular Adapter  
**504-209** DE9 Male to 8x8 Modular Adapter

**D-Sub Modular Adapter**

- Grey plastic hood with long thumbscrews

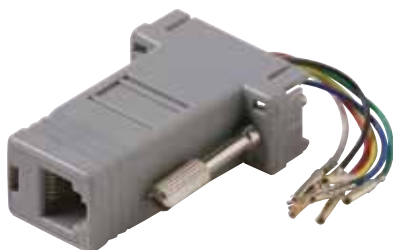

**504-217** DE9 Female to 6x6 Modular Adapter  
**504-219** DE9 Female to 8x8 Modular Adapter

**D-Sub Modular Adapter**

- Grey plastic hood with long thumbscrews



**504-307** DB25 Male to 6x6 Modular Adapter  
**504-309** DB25 Male to 8x8 Modular Adapter

**D-Sub Modular Adapter**

- Grey plastic hood with long thumbscrews



**504-319** DB25 Female to 8x8 Modular Adapter

**Contact your  
Stereon Representative  
for more information**

**Phone: (800) 266-3333**



### Modular Telephone Cord

- Flat modular cable – PVC jacket
- Suitable for telephone, VoIP telephone applications
- 28 AWG stranded conductors
- Cross-wired for telephone-voice applications

- 304-003** 3' 4C Telephone Line Cord, SL
- 304-007** 7' 4C Telephone Line Cord, IV / SL / WH
- 304-015** 15' 4C Telephone Line Cord, IV / SL / WH
- 304-025** 25' 4C Telephone Line Cord, BK / IV / SL / WH
- 304-050** 50' 4C Telephone Line Cord SL
- 304-100** 100' 4C Telephone Line Cord, BK / SL / WH



### Modular Telephone Cord

- Flat modular cable – PVC jacket
- Suitable for telephone, VoIP telephone applications
- 28 AWG stranded conductors
- Cross-wired for telephone-voice applications

- 306-007** 7' 6C Telephone Line Cord, SL
- 306-015** 15' 6C Telephone Line Cord, SL
- 306-025** 25' 6C Telephone Line Cord, SL



### Modular Telephone Cord

- Flat modular cable – PVC jacket
- Suitable for telephone, VoIP telephone applications
- 26AWG stranded conductors
- Cross-wired for telephone-voice applications
- UL version

- 314-007** 7ft 26AWG/4C Telephone Line Cord UL, SL
- 314-015** 15ft 26AWG/4C Telephone Line Cord UL, SL
- 314-025** 25ft 26AWG/4C Telephone Line Cord UL, SL



### Modular Data Cable

- Flat modular cable – PVC jacket
- 28 AWG stranded conductors
- Straight-wired for data applications

- 304-707** 7' 4C Data Cable, SL / WH
- 304-715** 15' 4C Data Cable, SL
- 304-725** 25' 4C Data Cable, SL



### Modular Data Cable

- Flat modular cable – PVC jacket
- 28 AWG stranded conductors
- Straight-wired for data applications

- 306-707** 7' 6C Data Cable, SL
- 306-715** 15' 6C Data Cable, SL



### Modular Data Cable

- Flat modular cable – PVC jacket
- 28 AWG stranded conductors
- Straight-wired for data applications

- 308-707** 7' 8C Data Cable, SL



### Coiled Handset Cord

- 4x4 4-Wire 28 AWG twisted tinsel conductors

- 302-007** 7' Handset Cord, BK
- 302-012** 12' Handset Cord, BK
- 302-015** 15' Handset Cord, BK / IV
- 302-025** 25' Handset Cord, BK



### Non-Booted CAT5E Patch Cord

- Non-booted, flexible data cables connect hub to patch-panel or wall-outlet to workstation
- Suitable for high-speed data applications, including gigabit ethernet, fast ethernet and 155Mbps TP-PMD/CDDI
- 4-Pair 24 AWG-stranded copper UTP cable
- 100% Tested wiring sequence and continuity
- Flame retardant - type CM
- Exceeds EIA/TIA 568B
- UL/cUL or ETL Listed

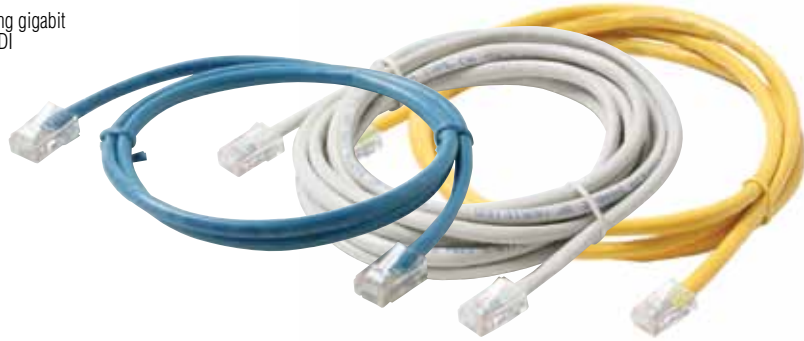

- 308-503** 3' Cat5e UTP Patch Cord, BL / GY  
**308-505** 5' Cat5e UTP Patch Cord, BL / GY / YL  
**308-507** 7' Cat5e UTP Patch Cord, BL / GY / WH / YL  
**308-510** 10' Cat5e UTP Patch Cord, BL / GY / YL

- 308-514** 14' Cat5e UTP Patch Cord, BL / GY / YL  
**308-525** 25' Cat5e UTP Patch Cord, BL / GY / YL  
**308-550** 50' Cat5e UTP Patch Cord, BL / GY  
**308-575** 75' Cat5e UTP Patch Cord, BL / GY

### Flush-Mold Booted CAT5E Cord

- Flush-mold-injected booted snagless category-5E patch cords
- Suitable for high-speed data applications, including gigabit ethernet, fast ethernet and 155Mbps TP-PMD/CDDI
- 4-Pair 24 AWG-stranded copper UTP cable
- 100% Tested wiring sequence and continuity
- Flame retardant - type CM
- Exceeds EIA/TIA 568B
- UL/cUL or ETL Listed



- 308-603** 3' Cat5e UTP Molded Patch Cord, BK / BL / GR / GY / RD / WH / YL  
**308-605** 5' Cat5e UTP Molded Patch Cord, BK / BL / GR / GY / RD / WH / YL  
**308-607** 7' Cat5e UTP Molded Patch Cord, BK / BL / GR / GY / PUR / WH / YL  
**308-610** 10' Cat5e UTP Molded Patch Cord, BK / BL / GR / GY / WH / YL  
**308-614** 14' Cat5e UTP Molded Patch Cord, BK / BL / GR / GY / PUR / WH / YL

- 308-625** 25' Cat5e UTP Molded Patch Cord, BK / BL / GR / GY / RD / WH / YL  
**308-650** 50' Cat5e UTP Molded Patch Cord, BK / BL / GR / GY / WH / YL  
**308-675** 75' Cat5e UTP Molded Patch Cord, BK / BL / GR / GY / WH / YL  
**308-600** 100' Cat5e UTP Molded Patch Cord, BK / BL / GR / GY / WH / YL

### Fast Media™ CAT6 Patch Cord

- Fast Media™ CAT6 booted patch cords
- Ultra-high-performance data communications cable
- Critical network applications, gigabit ethernet, fast ethernet, broadband audio and video, 155Mbps ATM, 100Mbps TP-PMD/CDDI, NEXT, ELFEXT and RL bandwidth compliant
- 4-Pair 23 AWG-stranded copper UTP cable
- 100% Tested wiring sequence and continuity
- Flame retardant - type CM
- Exceeds category-6 ANSI/TIA/EIA 568B.2-1 standards
- UL/cUL or ETL Listed



- 308-900** 100' Cat6 UTP Molded Patch Cord, GY  
**308-903** 3' Cat6 UTP Molded Patch Cord, BK / BL / GR / GY / RD / YL  
**308-905** 5' Cat6 UTP Molded Patch Cord, BL / GR / GY / WH / YL  
**308-907** 7' Cat6 UTP Molded Patch Cord, BL / GR / GY / YL

- 308-910** 10' Cat6 UTP Molded Patch Cord, BK / BL / GY / WH / YL  
**308-914** 14' Cat6 UTP Molded Patch Cord, BL / GY  
**308-925** 25' Cat6 UTP Molded Patch Cord, BL / GY  
**308-950** 50' Cat6 UTP Molded Patch Cord, BL / GY  
**308-975** 75' Cat6 UTP Molded Patch Cord, BL / GY





**USB Patch Cable**

- USB OTG A to micro B patch cable



**506-113** 3' USB OTG A to Micro B Patch Cable, BK  
**506-116** 3' USB OTG A to Micro B Patch Cable, BK

**USB Patch Cable**

- USB OTG micro A to micro B patch cable



**506-133** 3' USB OTG Micro A to Micro B Patch Cable, BK  
**506-136** 6' USB OTG Micro A to Micro B Patch Cable, BK

**USB Patch Cable**

- USB OTG micro B to micro B patch cable



**506-153** 3' USB OTG Micro B to Micro B Patch Cable, BK  
**506-156** 6' USB OTG Micro B to Micro B Patch Cable, BK

**USB v1.1 Serial Data Cable**

- USB v1.1 compliant data cables
- Supports 1.5 or 12Mbps transfer - hot-swappable
- Suitable for connections to modems, printers, keyboard, mice, digital cameras and external drives
- Flexible ash-grey PVC jacket - molded construction
- USB Type A male to Type A connectors
- UL Listed

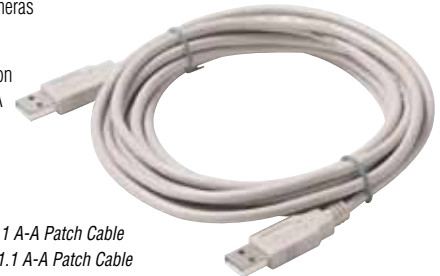

**506-306** 6' USB 1.1 A-A Patch Cable  
**506-310** 10' USB 1.1 A-A Patch Cable  
**506-315** 15' USB 1.1 A-A Patch Cable

**USB v2.0 Serial Data Cable**

- Premium high-speed USB v2.0 certified cables
- Supports 1.5/12/480 Mbps transfer - hot-swappable
- Backward-compatible with USBv1.1 devices
- Flexible PVC jacket - molded construction
- USB Type A male to Type A male connectors
- UL Listed

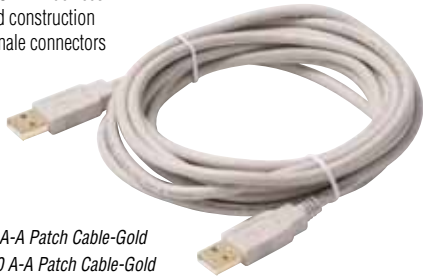

**506-356** 6' USB 2.0 A-A Patch Cable-Gold  
**506-360** 10' USB 2.0 A-A Patch Cable-Gold  
**506-365** 15' USB 2.0 A-A Patch Cable-Gold

**USB v1.1 Serial Data Cable**

- USB v1.1 Compliant data cables
- Supports 1.5 or 12Mbps transfer - hot-swappable
- Flexible ash-grey PVC jacket - molded construction
- USB Type A male to Type B male connectors
- UL Listed



**506-403** 3' USB 1.1 A-B Patch Cable  
**506-406** 6' USB 1.1 A-B Patch Cable  
**506-415** 15' USB 1.1 A-B Patch Cable

**USB v2.0 Serial Data Cable**

- Premium high-speed USB v2.0 certified cables
- Supports 1.5/12/480 Mbps transfer - hot-swappable
- Backward-compatible with USBv1.1 devices
- Flexible PVC jacket - molded construction
- USB Type A male to Type B male connectors
- UL Listed



**506-453** 3' USB 2.0 A-B Patch Cable-Gold  
**506-456** 6' USB 2.0 A-A Patch Cable-Gold  
**506-460** 10' USB 2.0 A-A Patch Cable-Gold  
**506-465** 15' USB 2.0 A-A Patch Cable-Gold

**USB v2.0 Serial Data Cable**

- Premium high-speed USB v2.0 certified cables
- Supports 1.5/12/480 Mbps transfer - hot-swappable
- Backward-compatible with USBv1.1 devices
- Flexible PVC jacket - molded construction
- USB Type A male to type mini B male connectors
- UL Listed

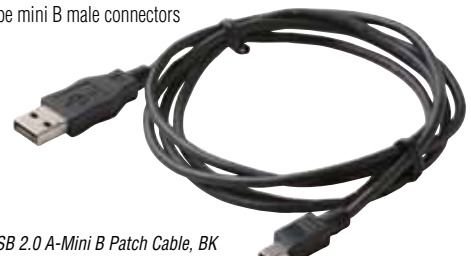

**506-513** 3' USB 2.0 A-Mini B Patch Cable, BK  
**506-516** 6' USB 2.0 A-Mini B Patch Cable, BK



**CABLES**  
USB / D-Sub / IEEE

**USB Adapter**

- Universal serial bus (USB) adapters
- Compatible with USB v1.1, v1.2, v2.0



**506-530** USB A Plug to Plug Adapter

**USB Adapter**

- Universal serial bus (USB) adapters
- Compatible with USB v1.1, v1.2, v2.0



**506-532** USB A Jack to Jack Adapter

**USB Adapter**

- Universal serial bus (USB) adapters
- Compatible with USB v1.1, v1.2, v2.0



**506-534** USB B Plug to Plug Adapter

**Mouse/Monitor Cable**

- Ash-grey jacket
- Rugged molded construction
- Long grip-textured slotted thumbscrews



**506-070** 6' DE15HD Male-Male VGA Cable  
**506-074** 10' DE15HD Male-Male VGA Cable

**IEEE1394 Digital Cable**

- Premium-grade IEEE1394 FireWire® cables
- Supports 393Mbps data transfer
- Hot swappable
- Suitable for connections to high-speed modems, digital and web cameras, digital camcorders, and scanners
- UL Listed



**506-606** 6' IEEE 1394 4/4 Pin Patch Cable

**IEEE1394 Digital Cable**

- Premium-grade IEEE1394 FireWire® cables
- Supports 393Mbps data transfer
- Hot swappable
- Suitable for connections to high-speed modems, digital and web cameras, digital camcorders, and scanners
- UL Listed



**506-706** 6' IEEE 1394 6/4 Pin Patch Cable

**IEEE1394 Digital Cable**

- Premium-grade IEEE1394 FireWire® cables
- Supports 393Mbps data transfer
- Hot swappable
- Suitable for connections to high-speed modems, digital and web cameras, digital camcorders, and scanners
- UL Listed



**506-806** 6' IEEE 1394 6/6 Pin Patch Cable

**Contact your  
Stereon Representative  
for more information**

**Phone: (800) 266-3333**



Wall Plates  
networking wall plates Cat5



Wall Plates



**TV Wall Plate**

- Modular TV standard wall plate
- High-performance F81 splices
- High-impact ABS plastic
- Flush-mount smooth finish
- Supplied with matching-color mounting screws
- Dimensions: 2 3/4"(W) x 4 1/2"(H)



**200-251** Standard TV Wall Plate, AL / IV / LA / WH  
**200-251-10** 10ct Standard TV Wall Plate, AL / IV / WH

**TV Wall Plate**

- Modular TV standard wall plate
- High-performance F81 splices
- High-impact ABS plastic
- Flush-mount smooth finish
- Supplied with matching-color mounting screws
- Dimensions: 2 3/4"(W) x 4 1/2"(H)



**200-252** Standard 2-TV Wall Plate, AL / IV / LA / WH  
**200-252-10** 10ct Standard 2-TV Wall Plate, AL / IV / WH

**TV Wall Plate**

- Modular TV standard wall plate
- High-impact ABS plastic
- flush-mount smooth finish
- Supplied with matching-color mounting screws
- Dimensions: 2 3/4"(W) x 4 1/2"(H)



**200-254** Standard TV 1-Hole Wall Plate, AL / BR / IV / WH

**TV Wall Plate**

- Modular TV standard wall plate
- High-performance F81 splice (200-058)
- Used in 2.5GHz version plates
- High-impact ABS plastic
- Flush-mount smooth finish
- Supplied with matching-color mounting screws
- Dimensions: 2 3/4"(W) x 4 1/2"(H)



**200-267** Standard 2.5GHz TV Wall Plate, AL / IV / WH  
**200-267-10** 10ct Standard 2.5GHz TV Wall Plate, IV / WH

**TV Wall Plate**

- Modular TV standard wall plate
- High-performance F81 splice (200-058)
- Used in 2.5GHz version plates
- High-impact ABS plastic
- Flush-mount smooth finish
- Supplied with matching-color mounting screws
- Dimensions: 2 3/4"(W) x 4 1/2"(H)



**200-268** Standard 2.5GHz 2-TV Wall Plate, AL / IV / WH  
**200-268-10** Standard 2.5GHz 2-TV Wall Plate, IV / WH

**TV Wall Plate**

- Modular TV standard wall plate
- High-impact ABS plastic
- flush-mount smooth finish
- Supplied with matching-color mounting screws
- Dimensions: 2 3/4"(W) x 4 1/2"(H)



**200-256** Standard TV 2-Hole Wall Plate, IV / WH

**TV-Telephone Wall Plate**

- Modular blank standard wall plate
- High-impact ABS plastic
- Flush-mount smooth finish
- Supplied with matching-color mounting screws
- Dimensions: 2 3/4"(W) x 4 1/2"(H)



**200-258AL** Standard Blank Wall Plate, AL / IV / LA / WH  
**200-258-10** 10ct Standard Blank Wall Plate, AL / IV / WH

**Mid-Size TV Wall Plate**

- Modular TV mid-size wall plate
- High-impact ABS plastic
- Flush-mount smooth finish
- Supplied with matching-color mounting screws
- High performance F81 splice
- Dimensions: 3 1/8"(W) x 4 7/8"(H)



**200-411** Mid-Sized TV Wall Plate, AL / IV / LA / WH



## AUDIO/VIDEO

### Mid-Size TV-Telephone Plate

- Modular blank mid-size wall plate
- High-impact ABS plastic
- Flush-mount smooth finish
- Supplied with matching-color mounting screws
- Dimensions: 3 1/8"(W) x 4 7/8"(H)



**200-418** Mid-Sized Blank Wall Plate, AL / IV / LA / WH

### Decorator-Style Wall Plate

- Single gang decorator-style flush plate
- High-impact ABS plastic mounting bracket
- Supplied with matching-color mounting screws
- Gold plated F81 splice
- Dimensions: 2 3/4"(W) x 4 1/2"(H)



**200-253** Standard TV Decorator Wall Plate (2-pc), IV / WH  
**200-253-10** 10ct Standard TV Decorator Wall Plate (2-pc), IV / WH

### Decorator-Style Wall Plate

- Single gang decorator-style flush plate
- High-impact ABS plastic mounting bracket
- Supplied with matching-color mounting screws
- Gold plated F81 splices
- Dimensions: 2 3/4"(W) x 4 1/2"(H)



**200-255** Standard 2-TV Decorator Wall Plate (2-pc), IV / WH  
**200-255-10** Standard 2-TV Decorator Wall Plate (2-pc), WH

### Decorator-Style Wall Plate

- Single gang decorator-style flush plate
- Gold-plated RCA jack to solder contact
- High-impact ABS plastic mounting bracket
- Supplied with matching-color mounting screws
- Dimensions: 2 3/4"(W) x 4 1/2"(H)



**200-260** Standard 3-RCA Decorator Wall Plate (2-pc), WH  
**200-260-10** 10ct Standard 3-RCA Decorator Wall Plate (2-pc), WH

### Economy Decorator Wall Plate

- Flush-mount TV wall plate
- High-impact ABS plastic with mounting hardware
- Dimensions: 2 3/4"(W) x 4 1/2"(H)



**200-261** Standard TV 1-Hole Decorator Wall Plate (1-pc), IV / WH

### Economy Decorator Wall Plate

- Flush-mount TV wall plate
- High-impact ABS plastic with mounting hardware
- Dimensions: 2 3/4"(W) x 4 1/2"(H)



**200-263** Standard TV 1-Hole Offset Decorator Wall Plate (1-pc), IV / WH

### Economy Decorator Wall Plate

- Flush-mount TV wall plate
- High-impact ABS plastic with mounting hardware
- High performance F81 splice
- Dimensions: 2 3/4"(W) x 4 1/2"(H)



**200-265** Standard TV Decorator Wall Plate (1-pc), IV / WH

### Economy Decorator Wall Plate

- Flush-mount TV wall plate
- High-Impact ABS plastic with mounting hardware
- High performance 1GHz F81 splice
- Dimensions: 2 3/4"(W) x 4 1/2"(H)



**200-266** Standard TV Decorator Wall Plate (1-pc), IV / WH  
**200-266-10** 10ct Standard TV Decorator Wall Plate (1-pc), IV / WH



**HDMI® Wall Plate**

- Flush mount decorator-style HDMI wall plate
- Feed-through design
- High-impact ABS plastic with mounting hardware
- Dimensions: 2 3/4"(W) x 4 1/2"(H)



**516-101** Standard HDMI Wall Plate, WH

**HDMI® Wall Plate**

- Flush mount decorator-style HDMI wall plate
- Dual feed-through design
- High-impact ABS plastic with mounting hardware
- Dimensions: 2 3/4"(W) x 4 1/2"(H)



**516-102** Standard 2-HDMI Wall Plate, WH

**HDMI® Wall Plate**

- Flush mount decorator-style HDMI wall plate
- HDMI feed-through design with RCA jack
- High-impact ABS plastic with mounting hardware
- Dimensions: 2 3/4"(W) x 4 1/2"(H)



**516-108** Standard HDMI+ RCA Jack Wall Plate, WH

**HDMI® Wall Plate**

- Flush mount decorator-style HDMI wall plate
- HDMI feed-through design with F splice
- High-impact ABS plastic with mounting hardware
- Dimensions: 2 3/4"(W) x 4 1/2"(H)



**516-111** Standard HDMI + F Jack Wall Plate, WH

**HDMI® Wall Plate**

- Flush mount decorator-style HDMI wall plate
- HDMI Feed-through design with 2 RCA Jacks
- High-impact ABS plastic with mounting hardware
- Dimensions: 2 3/4"(W) x 4 1/2"(H)



**516-113** Standard HDMI + 2-RCA Jack (R/W Insulator) Wall Plate, WH

**HDMI® Wall Plate**

- Flush mount decorator-style HDMI wall plate
- HDMI feed-through design with 3 RCA jacks
- High-impact ABS plastic with mounting hardware
- Dimensions: 2 3/4"(W) x 4 1/2"(H)



**516-115** Standard HDMI + 3-RCA Jack (Y/R/W Insulator) Wall Plate, WH

**HDMI® Wall Plate**

- Flush mount decorator-style HDMI wall plate
- HDMI feed-through design with 3 RCA jacks
- High-impact ABS plastic with mounting hardware
- Dimensions: 2 3/4"(W) x 4 1/2"(H)



**516-117** Standard HDMI + 3-RCA Jack (R/G/B Insulator) Wall Plate, WH

**Contact your  
Stereon Representative  
for more information**

**Phone: (800) 266-3333**



**AUDIO VIDEO**

**HDMI® Pigtail Wall Plate**

- In-wall wiring solution between audio/video components with a neat, clean exterior connection point
- 8.5" HDMI female to female pigtail cable ready for plug and play use
- Home theater audio/video connections



**526-101** Standard HDMI Pigtail Wall Plate, IV / WH

**HDMI® Pigtail Wall Plate**

- In-wall wiring solution between audio/video components with a neat, clean exterior connection point
- 8.5" HDMI female to female pigtail cable ready for plug and play use
- Home theater audio/video connections

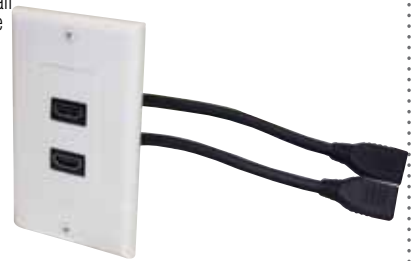

**526-102** Standard 2-HDMI Pigtail Wall Plate, IV / WH

**HDMI® Pigtail Wall Plate**

- In-wall wiring solution between audio/video components with a neat, clean exterior connection point
- 8.5" HDMI female to female pigtail cable ready for plug and play use
- Home theater audio/video connections



**526-111** Standard HDMI Pigtail + F Jack Wall Plate, IV / WH

**HDMI® Pigtail Wall Plate**

- In-wall wiring solution between audio/video components with a neat, clean exterior connection point
- 8.5" HDMI female to female pigtail cable ready for plug and play use
- Home theater audio/video connections



**526-115** Standard HDMI Pigtail + 3-RCA Jack (Y/R/W) Wall Plate, IV / WH

**HDMI® Pigtail Wall Plate**

- In-wall wiring solution between audio/video components with a neat, clean exterior connection point
- 8.5" HDMI female to female pigtail cable ready for plug and play use
- Home theater audio/video connections



**526-117** Standard HDMI Pigtail + 3-RCA Jack (R/G/B) Wall Plate, IV / WH

**Contact your Steren Representative for more information**

**Phone: (800) 266-3333**





**Telephone Wall Plate**

- Modular telephone standard wall plate
- High-impact ABS Plastic
- Gold-plated contacts
- Flush-mount smooth finish
- Matching color mounting screws
- Dimensions: 2 3/4"(W) x 4 1/2"(H)



**300-204** Standard 4C Tel Wall Plate, AL / IV / LA / WH  
**300-204-10** 10ct Standard 4C Tel Wall Plate, AL / IV / WH

**Telephone Wall Plate**

- Modular telephone standard wall plate
- High-impact ABS Plastic
- Gold-plated contacts
- Flush-mount smooth finish
- Matching color mounting screws
- Dimensions: 2 3/4"(W) x 4 1/2"(H)



**300-206** Standard 6C Tel Wall Plate, IV / WH  
**300-206-10** 10ct Standard 6C Tel Wall Plate, IV / WH

**Telephone Wall Plate**

- Modular telephone standard wall plate
- High-impact ABS Plastic
- Gold-plated contacts
- Flush-mount smooth finish
- Matching color mounting screws
- Dimensions: 2 3/4"(W) x 4 1/2"(H)



**300-214** Standard 4C 2-Tel Wall Plate, AL / IV / LA / WH  
**300-214-10** 10ct Standard 4C 2-Tel Wall Plate, AL / IV / WH  
**300-215** Standard 4C 2-Tel Bridged Wall Plate, IV / WH

**Telephone Wall Plate**

- Modular telephone standard wall plate
- High-impact ABS Plastic
- Gold-plated contacts
- Flush-mount smooth finish
- Matching color mounting screws
- Dimensions: 2 3/4"(W) x 4 1/2"(H)



**300-216** Standard 6C 2-Tel Wall Plate, IV / WH  
**300-216-10** 10ct Standard 6C 2-Tel Wall Plate, IV / WH

**Telephone Wall Plate**

- Tel-diplexer ivory smooth jack



**300-243** Standard 4C 2-Tel + TV Wall Plate , IV  
**300-243-10** 10ct Standard 4C 2-Tel + TV Wall Plate , IV / WH

**Telephone Wall Plate**

- Modular telephone standard wall plate
- High-impact ABS Plastic
- Gold-plated contacts
- Flush-mount smooth finish
- Matching color mounting screws
- Dimensions: 2 3/4"(W) x 4 1/2"(H)
- UL Listed



**301-004** Standard 4C Tel Wall Plate UL, WH

**Telephone Wall Plate**

- Modular telephone standard wall plate
- High-impact ABS Plastic
- Gold-plated contacts
- Flush-mount smooth finish
- Matching color mounting screws
- Dimensions: 2 3/4"(W) x 4 1/2"(H)
- UL Listed



**301-014** Standard 4C 2-Tel Wall Plate UL, WH  
**301-016** SStandard 6C 2-Tel Wall Plate UL, WH

**Telephone Wall Plate**

- Modular telephone standard wall plate
- High-impact ABS Plastic
- Gold-plated contacts
- Flush-mount smooth finish
- Matching color mounting screws
- Dimensions: 2 3/4"(W) x 4 1/2"(H)
- UL Listed



**301-204** Standard 4C Tel Wall Plate UL, AL / IV / WH  
**301-204-10** 10ct Standard 4C Tel Wall Plate UL, AL / IV / WH



**TELEPHONY**

**Telephone Wall Plate**

- Modular telephone standard wall plate
- High-impact ABS Plastic
- Gold-plated contacts
- Flush-mount smooth finish
- Matching color mounting screws
- Dimensions: 2 3/4"(W) x 4 1/2"(H)
- UL Listed



**301-214** Standard 4C 2-Tel Wall Plate UL, AL / IV / WH  
**301-214-10** 10ct Standard 4C 2-Tel Wall Plate UL, AL / IV / WH

**Mid-Size Telephone Plate**

- Modular telephone mid-size wall plate
- High-impact ABS Plastic
- Gold-plated contacts
- Flush-mount smooth finish
- Matching color mounting screws
- Dimensions: 3 1/8"(W) x 4 7/8"(H)



**300-203** Mid-Sized 4C Tel Wall Plate, AL / IV / LA / WH

**Mid-Size Telephone Plate**

- Modular telephone mid-size wall plate
- High-impact ABS Plastic
- Gold-plated contacts
- Flush-mount smooth finish
- Matching color mounting screws
- Dimensions: 3 1/8"(W) x 4 7/8"(H)



**300-213** Mid-Sized 4C 2-Tel Wall Plate, IV / LA / WH

**TV-Telephone Wall Plate**

- TV-telephone standard wall plate
- Gold-plated telephone contacts
- High-performance F81 splice
- High-impact ABS plastic
- Flush-mount smooth finish
- Supplied with matching color mounting screws
- Dimensions: 2 3/4"(W) x 4 1/2"(H)



**300-234** Standard 4C Tel + TV Wall Plate, AL / IV / LA / WH  
**300-234-10** 10ct Standard 4C Tel + TV Wall Plate, AL / IV / WH

**TV-Telephone Wall Plate**

- TV-telephone standard wall plate
- Gold-plated telephone contacts
- High-performance F81 splices (200-058) used in 2.5GHz version plates
- High-Impact ABS plastic
- Flush-mount smooth finish
- Supplied with matching color mounting screws
- Dimensions: 2 3/4"(W) x 4 1/2"(H)



**300-235** Standard 4C Tel + 2.5GHz TV Wall Plate, AL / BR / IV / WH  
**300-235-10** 10ct Standard 4C Tel + 2.5GHz TV Wall Plate, IV / WH

**TV-Telephone Wall Plate**

- TV-telephone standard wall plate
- Gold-plated telephone contacts
- High-performance F81 splice
- High-impact ABS plastic
- Flush-mount smooth finish
- Supplied with matching color mounting screws
- Dimensions: 2 3/4"(W) x 4 1/2"(H)



**300-237** Standard 4C Tel + 2-TV Wall Plate, IV / WH  
**300-237-10** 10ct Standard 4C Tel + 2-TV Wall Plate, IV / WH

**TV-Telephone Wall Plate**

- TV-telephone standard wall plate
- Gold-plated telephone contacts
- High-performance F81 splices (200-058) used in 2.5GHz version plates
- High-Impact ABS plastic
- Flush-mount smooth finish
- Supplied with matching color mounting screws
- Dimensions: 2 3/4"(W) x 4 1/2"(H)



**300-238** Standard 4C Tel + 2.5GHz, 2-TV Wall Plate, IV / WH  
**300-238-10** 10ct Standard 4C Tel + 2.5GHz, 2-TV Wall Plate, IV / WH

**TV-Telephone Wall Plate**

- Telephone-TV wall plate
- Suitable for CATV
- High-impact ABS plastic
- Gold-plated contacts
- Flush-mount smooth finish
- Matching color mounting screws
- Dimensions: 2 3/4"(W) x 4 1/2"(H)
- UL Listed



**301-234** Standard 4C Tel + TV Wall Plate UL, AL / IV / WH  
**301-234-10** 10ct Standard 4C Tel + TV Wall Plate UL, IV / WH



### Mid-Size TV-Telephone Plate

- TV-Telephone mid-size wall plate
- Gold-plated contacts
- High-performance F81 splice
- High-impact ABS plastic
- Flush-mount smooth finish
- Supplied with matching color mounting screws
- Dimensions: 3 1/8"(W) x 4 7/8"(H)



**300-233** Mid-Sized 4C Tel + TV Wall Plate, AL / IV / LA / WH

### Junction Box

- Surface mount junction box
- Suitable for single-gang wall plate
- High-impact ABS plastic
- Threaded brass inserts
- Dimensions: 2 3/4"(W) x 4 1/2"(H) x 1 7/8"(D)



**310-100** Surface Mount Junction Box, IV / WH  
**310-103** Single Gang Low Voltage Cut-In Ring

### Round Phone Jack

- 4C Round modular telephone jack
- High-impact ABS plastic
- Gold-plated contacts
- Matching color mounting screws



**300-054** Modular 4C Round Wall Jack, IV / WH

### Wall Phone Jack

- Wall-mounted-telephone modular jack plate
- High-Impact ABS Plastic
- Gold-plated contacts
- Matching color mounting screws



**300-090** Standard 4C 3-Jack Tel Hanging Wall Plate, IV

### Wall Phone Jack

- Wall-mounted-telephone modular jack plate
- High-impact ABS plastic
- Gold-plated contacts
- Matching-color mounting screws



**300-094** Standard 4C Tel Hanging Wall Plate, IV / WH  
**300-094-10** 10ct Standard 4C Tel Hanging Wall Plate, IV / WH

### Wall Phone Jack

- Wall-mounted-telephone modular jack plate
- Gold-plated contacts
- Steel



**300-095** Standard 4C Tel Hanging Wall Plate Steel

**Contact your  
Steren Representative  
for more information**

**Phone: (800) 266-3333**

**TELEPHONY/ CUSTOM NETWORKING**  
**Wall Plates**

**Wall Phone Jack**

- Wall-mounted-telephone modular jack plate
- High-impact ABS plastic
- Gold-plated contacts
- Matching color mounting screws
- UL Listed



**301-094** Standard 4C Tel Wall Plate UL, IV / WH

**Decorator-Style Wall Plate**

- Single-gang decorator-Style flush plate
- Mounts in standard electrical boxes
- Includes cover plate and jack assembly
- High-impact ABS plastic mounting bracket
- Gold-plated contacts
- Matching color mounting screws
- Dimensions: 2 3/4"(W) x 4 1/2"(H)



**300-003** Standard 4C Tel Decorator Wall Plate (2-pc), IV / LA / WH  
**300-103-10** 10ct Standard 4C Tel + TV Decorator Wall Plate (2-pc), IV / WH

**Modular Surface Jack**

- Modular telephone surface jack
- High-impact ABS Plastic with mounting screws
- Gold-plated contacts



**300-145** 4C Tel Surface Jack, IV / WH  
**300-147** 6C Tel Surface Jack, IV / WH  
**300-149** 8C Data Surface Jack, IV / WH

**Modular Surface Jack**

- Modular telephone surface jack
- High-impact ABS Plastic with mounting screws
- Gold-plated contacts



**300-146** 4C 2-Tel Surface Jack, IV / WH

**Modular Surface Jacks**

- Modular telephone surface jack
- High-impact ABS Plastic with mounting screws
- Gold-plated contacts
- UL Listed



**301-146** 4C 2-Tel Surface Jack UL, IV / WH

**Telephone Adapter**

- Modular telephone adapter
- High-impact ABS plastic
- Gold-plated contacts
- UL Listed



**301-024** Modular 4C Tel T Adapter UL, IV

**Keystone Wall Plate**

- Flush mount keystone wall plate
- 1 Cavity
- Holds industry standard modular keystone inserts
- Smooth finish high-impact ABS construction
- Matching color mounting screws
- UL Listed
- Dimensions: 2 3/4"(W) x 4 1/2"(H)



**310-201** Standard Keystone 1-Port Wall Plate, AL / BK / IV / LA / WH  
**310-201-10** 10ct Standard Keystone 1-Port Wall Plate, AL / IV / WH

**Keystone Wall Plate**

- Flush mount keystone wall plate
- 2 Cavity
- Holds industry standard modular keystone inserts
- Smooth finish high-impact ABS construction
- Matching color mounting screws
- UL Listed
- Dimensions: 2 3/4"(W) x 4 1/2"(H)



**310-202** Standard Keystone 2-Port Wall Plate, AL / BK / IV / LA / WH  
**310-202-10** 10ct Standard Keystone 2-Port Wall Plate, AL / IV / WH



### Keystone Wall Plate

- Flush mount keystone wall plate
- 3 Cavity
- Holds industry standard modular keystone inserts
- Smooth finish high-impact ABS construction
- Matching color mounting screws
- UL Listed
- Dimensions: 2 3/4"(W) x 4 1/2"(H)



**310-203** Standard Keystone 3-Port Wall Plate, AL / BK / IV / LA / WH  
**310-203-10** 10ct Standard Keystone 3-Port Wall Plate, AL / IV / WH

### Keystone Wall Plate

- Flush mount keystone wall plate
- 4 Cavity
- Holds industry standard modular keystone inserts
- Smooth finish high-impact ABS construction
- Matching color mounting screws
- UL Listed
- Dimensions: 2 3/4"(W) x 4 1/2"(H)



**310-204** Standard Keystone 4-Port Wall Plate, AL / BK / IV / LA / WH  
**310-204-10** 10ct Standard Keystone 4-Port Wall Plate, AL / IV / WH

### Keystone Wall Plate

- Flush mount keystone wall plate
- 6 Cavity
- Holds industry standard modular keystone inserts
- Smooth finish high-impact ABS construction
- Matching color mounting screws
- UL Listed
- Dimensions: 2 3/4"(W) x 4 1/2"(H)



**310-206** Standard Keystone 6-Port Wall Plate, AL / BK / IV / LA / WH  
**310-206-10** 10ct Standard Keystone 6-Port Wall Plate, AL / IV / WH

### Receptacle Wall Plate

- Suitable for standard-size single
- Fits standard electrical switch boxes
- High-impact ABS plastic
- Smooth finish
- Includes matching-color mounting screws
- UL Listed
- Single – dimensions: 2 3/4"(W) x 4 1/2"(H) x 5/16"(D)
- Dual – dimensions: 4 9/16"(W) x 4 1/2"(H) x 5/16"(D)



**310-820** Standard Single Gang Duplex Wall Plate, IV / WH

### Receptacle Wall Plate

- Suitable for standard-size duplex electrical receptacles
- Fits standard electrical switch boxes
- High-impact ABS plastic
- Smooth finish
- Includes matching color mounting screws
- UL Listed



**310-822** Standard Dual Gang Duplex Wall Plate, IV / WH

### Receptacle Wall Plate

- Suitable for standard-size single electrical receptacles
- Fits standard electrical switch boxes
- High-impact ABS plastic
- Smooth finish
- Includes matching color mounting screws
- UL Listed



**310-830** Standard Single Gang Single Recept Wall Plate, WH

### Decorator-Style Wall Plate

- Decorator-style flush wall plate for residential or commercial structured wiring
- Smooth finish high-impact ABS plastic
- Matching color mounting screws
- UL Listed



**310-801** Standard Single Gang Decorator Wall Plate, IV / WH  
**310-801-10** 10ct Standard Single Gang Decorator Wall Plate, WH

### Decorator-Style Wall Plate

- Decorator-style flush wall plate for residential or commercial structured wiring
- Smooth finish high-impact ABS plastic
- Matching color mounting screws
- UL Listed



**310-802** Standard Dual Gang Decorator Wall Plate, WH  
**310-802-10** 10ct Standard Dual Gang Decorator Wall Plate, WH



**CUSTOM NETWORKING**  
Wall Plates

**Decorator-Style Wall Plate**

- Decorator-style flush wall plate for residential or commercial structured wiring
- Smooth finish high-impact ABS plastic
- Matching color mounting screws
- UL Listed



**310-803** Standard Triple Gang Decorator Wall Plate, WH  
**310-803-10** 10ct Standard Triple Gang Decorator Wall Plate, WH

**Decorator-Style Wall Plate**

- Decorator-style flush wall plate for residential or commercial structured wiring
- Smooth finish high-impact ABS plastic
- Matching color mounting screws
- UL Listed



**310-804** Standard Four Gang Decorator Wall Plate IV / WH

**Decorator-Style Insert**

- For use with decorator-style wall plate
- Smooth finish high-impact ABS plastic construction
- Matching color mounting screws
- UL Listed



**310-851** Keystone 1-Port Decorator Insert, WH

**Decorator-Style Insert**

- For use with decorator-style wall plate
- Smooth finish high-impact ABS plastic construction
- Matching color mounting screws
- UL Listed



**310-852** Keystone 2-Port Decorator Insert, WH

**Decorator-Style Insert**

- For use with decorator-style wall plate
- Smooth finish high-impact ABS plastic construction
- Matching color mounting screws
- UL Listed



**310-853** Keystone 3-Port Decorator Insert, WH

**Decorator-Style Insert**

- For use with decorator-style wall plate
- Smooth finish high-impact ABS plastic construction
- Matching color mounting screws
- Not designed for side by side category jacks
- UL Listed



**310-854** Keystone 4-Port Decorator Insert, WH

**Decorator-Style Inserts**

- For use with decorator-style wall plate
- Smooth finish high-impact ABS plastic construction
- Matching color mounting screws
- UL Listed



**310-860** Keystone 1-Port + Barrel 2-Port Decorator Insert, WH

**Round-Cavity Decorator-Style Inserts**

- Ideal for residential or commercial structured wiring
- Designed for custom indoor audio/video applications
- Fits securely into decorator-style wall plates
- Smooth finish high-impact ABS plastic
- 1 Round-cavity style
- Matching color mounting screws
- UL Listed



**310-871** Barrel 1-Port Decorator Insert, WH



### Round-Cavity Decorator-Style Inserts

- Ideal for residential or commercial structured wiring
- Designed for custom indoor audio/video applications
- Fits securely into decorator-style wall plates
- Smooth finish high-impact ABS plastic
- 2 Round-cavity style
- Matching color mounting screws
- UL Listed



**310-872** Barrel 2-Port Decorator Insert, WH

### Round-Cavity Decorator-Style Inserts

- Ideal for residential or commercial structured wiring
- Designed for custom indoor audio/video applications
- Fits securely into decorator-style wall plates
- Smooth finish high-impact ABS plastic
- 4 Round-cavity style
- Matching color mounting screws
- UL Listed



**310-874** Barrel 4-Port Decorator Insert, WH

### Round-Cavity Decorator-Style Inserts

- Ideal for residential or commercial structured wiring
- Designed for custom indoor audio/video applications
- Fits securely into decorator-style wall plates
- Smooth finish high-impact ABS plastic
- 6 Round-cavity style
- Matching color mounting screws
- UL Listed



**310-876** Barrel 6-Port Decorator Insert, WH

### Round-Cavity Decorator-Style Inserts

- Ideal for residential or commercial structured wiring
- Designed for custom indoor audio/video applications
- Fits securely into decorator-style wall plates
- Smooth finish high-impact ABS plastic
- 8 Round-cavity style
- Matching color mounting screws
- UL Listed



**310-878** Barrel 8-Port Decorator Insert, WH

### Keystone Modular Jack

- Category-3 voice grade UL Listed RJ12 keystone jacks
- Quick snap-down-cover termination
- 22-26 AWG IDC contacts
- UL94V-0 Thermoplastic ABS housing



**310-106** Keystone 6C RJ12 Jack, AL / BK / IV / LA / WH  
**310-106-10** 10ct Keystone 6C RJ12 Jack, BK / IV / WH

### Keystone Modular Jack

- Category-3 voice grade UL Listed RJ45 keystone jacks
- Quick snap-down-cover termination
- 22-26 AWG IDC contacts
- UL94V-0 Thermoplastic ABS housing



**310-108** Keystone 8C RJ45 Jack, BK / IV / WH  
**310-108-10** 10ct Keystone 8C RJ45 Jack, BK / IV / WH

### Category-5E Keystone Jack

- Category-5E UL verified and listed keystone jack
- 22-26 AWG 110-IDC Contacts
- UL94V-0 Thermoplastic ABS housing 180°



**310-110** Keystone Cat5e RJ45 Jack, AL / BK / BL / GR / IV / LA / OR / RD / WH / YL  
**310-110-10** 10 ct Keystone Cat5e RJ45 Jack, BK / IV / WH

### Category-5E Keystone Jack

- Category-5E UL verified and listed keystone jack
- 22-26 AWG 110-IDC Contacts
- UL94V-0 Thermoplastic ABS housing 180°



**310-120** Keystone Cat5e RJ45 90° Jack, AL / BK / BL / GR / IV / LA / OR / RD / WH / YL  
**310-120-10** 10 ct Keystone Cat5e RJ45 90° Jack, BK / IV / WH

**CUSTOM NETWORKING**  
Modular Jacks

**Fast Media™ Category-6 Jack**

- Fast Media™ keystone category-6 UL jack
- 22-24 AWG 110-IDC Contacts
- UL94V-0 Thermoplastic ABS housing 90°



**310-140** Keystone Cat6 RJ45 90° Jack, AL / BK / BL / GR / IV / LA / OR / PR / RD / WH / YL  
**310-140-10** 10 ct Keystone Cat6 RJ45 90° Jack, BK / IV / WH

**Fast Media™ CAT6 Tool-less Keystone Jack**

- Fast Media™ Category-6 UL keystone tool-less jack
- Self-terminating IDC mechanism
- 22-24 AWG 110-IDC Contacts
- UL94V-0 Thermoplastic ABS housing



**310-150** Keystone Cat6 RJ45 Toolless Jack, BK / BL / GR / IV / LA / OR / PR / RD / WH / YL

**Keystone Modular Insert**

- Connector-module insert used with keystone wall plates
- Snap-in tabs make modules easy to insert and remove for adjustments and wiring changes



**310-410** Keystone BNC Jack Adapter, AL / WH / LA

**Keystone Modular Insert**

- Connector-module insert used with keystone wall plates
- Snap-in tabs make modules easy to insert and remove for adjustments and wiring changes



**310-415** Keystone F Jack Adapter, AL / BK / IV / LA / WH  
**310-415-10** 10ct Keystone F Jack Adapter, IV / WH

**Keystone Modular Insert**

- Connector-module insert used with keystone wall plates
- Snap-In tabs make modules easy to insert and Remove for adjustments and wiring changes
- Create video, voice or data outlets using F, BNC, RCA, and other connections



**310-417** Keystone F Blank Insert, AL / IV / WH

**Keystone Modular Insert**

- Connector-module insert used with keystone wall plates
- Snap-in tabs make modules easy to insert and remove for adjustments and wiring changes



**310-420** Keystone Blank Insert, AL / BK / IV / LA / WH  
**310-420-10** 10ct Keystone Blank Insert, IV / WH

**Keystone Modular Insert**

- Connector-module insert used with keystone wall plates
- Snap-in tabs make modules easy to insert and remove for adjustments and wiring changes



**310-450** Keystone S-VHS Jack Insert, WH

**Keystone Modular Insert**

- Connector-module insert used with keystone wall plates
- Snap-in tabs make modules easy to insert and remove for adjustments and wiring changes



**310-451** Keystone S-VHS Jack to Plug Insert, WH





### Keystone Modular Insert

- Connector-module insert used with keystone wall plates
- Snap-in tabs make modules easy to insert and remove for adjustments and wiring changes



**310-452** Keystone S-VHS TO RCA Jack Adapter, WH

### Keystone Modular Insert

- Connector-module insert used with keystone wall plates
- Snap-in tabs make modules easy to insert and remove for adjustments and wiring changes



**310-461** Keystone RCA Jack Adapter Red Insulator, AL / IV / WH  
**310-461-10** 10ct Keystone RCA Jack Adapter Red Insulator, IV / WH

### Keystone Modular Insert

- Connector-module insert used with keystone wall plates
- Snap-in tabs make modules easy to insert and remove for adjustments and wiring changes



**310-463** Keystone RCA Jack Adapter White Insulator, IV / LA / WH  
**310-463-10** 10ct Keystone RCA Jack Adapter White Insulator, IV / WH

### Keystone Modular Insert

- Connector-module insert used with keystone wall plates
- Snap-in tabs make modules easy to insert and remove for adjustments and wiring changes



**310-464** Keystone RCA Jack Adapter Yellow Insulator, IV / WH  
**310-464-10** 10ct Keystone RCA Jack Adapter Yellow Insulator, IV / WH

### Keystone Modular Insert

- Connector-module insert used with keystone wall plates
- Snap-in tabs make modules easy to insert and remove for adjustments and wiring changes



**310-465** Keystone RCA Jack to F Jack Adapter, IV / WH  
**310-465-10** 10ct Keystone RCA Jack to F Jack Adapter, IV / WH

### Keystone Modular Insert

- Connector-module insert used with keystone wall plates
- Snap-in tabs make modules easy to insert and remove for adjustments and wiring changes



**310-466** Keystone RCA Jack to F Jack Adapter, IV / WH

### Keystone Modular Insert

- Connector-module insert used with keystone wall plates
- Snap-in tabs make modules easy to insert and remove for adjustments and wiring changes



**310-467** Keystone Binding Post/Banana Jack Black Band, IV / WH  
**310-467-10** 10ct Keystone Binding Post/Banana Jack Black Band, WH

### Keystone Modular Insert

- Connector-module insert used with keystone wall plates
- Snap-in tabs make modules easy to insert and remove for adjustments and wiring changes



**310-468** Keystone Binding Post/Banana Jack Red Band, IV / WH  
**310-468-10** Keystone Binding Post/Banana Jack Red Band, WH

**CUSTOM NETWORKING**  
Modular Jacks

**Keystone Modular Insert**

- Connector-module inserts used with Keystone wall plates
- Snap-in tabs make modules easy to insert and remove for adjustments and wiring changes



**310-485** Keystone HDM® Jack Adapter, IV / WH

**Keystone Surface Mount Box**



- Surface mount Keystone empty biscuit box
- Holds industry standard modular Keystone inserts
- High-impact UL94V-0 thermoplastic housing
- Installation kit includes mounting screws, double-sided adhesive pad, label and protective label cover



**310-161** Keystone 1-Port Surface Mount Housing, WH  
**310-161-10** 10ct Keystone 1-Port Surface Mount Housing, WH

**Keystone Surface Mount Box**



- Surface mount Keystone empty biscuit box
- Holds industry standard modular Keystone inserts
- High-impact UL94V-0 thermoplastic housing
- Installation kit includes mounting screws, double-sided adhesive pad, label and protective label cover



**310-162** Keystone 2-Port Surface Mount Housing, WH  
**310-162-10** 10ct Keystone 2-Port Surface Mount Housing, WH

**Category-5E Coupler**

- Category-5E jack-jack coupler
- Joins two RJ45 cords
- Reverse configuration

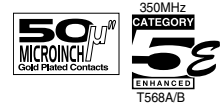

**310-042** Keystone Cat5e RJ45 Coupler, BK / WH  
**310-042-10** 10ct Keystone Cat5e RJ45 Coupler, BK / WH

**Category-5E Surface Jack**

- Surface mount biscuit block jack
- Category-5E UL verified and listed
- High-reliability printed-circuit board design
- 110-Termination 22-26 AWG tin-lead contact
- High-impact UL94V-0 thermoplastic housing
- Installation kit includes mounting screws, double-sided adhesive pad, designation label and protective label-cover



**301-151** Cat5e RJ45 Surface Jack, WH  
**301-151-10** 10ct Cat5e RJ45 Surface Jack, WH

**Category-5E Surface Jack**

- Surface mount biscuit block jack
- Category-5E UL verified and listed
- High-reliability printed-circuit board design
- 110-Termination 22-26 AWG tin-lead contact
- High-impact UL94V-0 thermoplastic housing
- Installation kit includes mounting screws, double-sided adhesive pad, designation label and protective label cover



**301-152** Cat5e 2-RJ45 Surface Jack, WH  
**301-152-10** 10ct Cat5e 2-RJ45 Surface Jack, WH

**Modular Surface Jack**

- Modular telephone or data surface jack
- High-impact ABS plastic with mounting screws
- Gold-plated contacts
- Shorting bar suitable for alarm system installation



**301-153** 8C RJ31X Surface Jack UL, IV

**Category-6 Coupler**

- Category-6 jack-jack coupler
- Joins two CAT6 RJ45 cords
- Reverse configuration
- Compliant with ANSI / TIA / EIA



**310-043** Keystone CAT6 RJ45 Coupler, BK / WH

### CAT5E 110-IDC Patch Panel

- Category-5E UL verified and listed patch panel
- High-reliability printed-circuit board design
- 110-termination 22-26 AWG tin-lead contact
- UL94V-0 black ABS modular jack banks
- Dual color-coded 568A/B wiring diagrams
- Numeric stencilled port ID labels

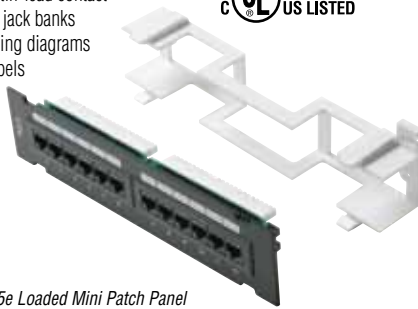
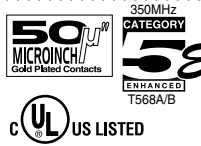

**310-320** 12-port Cat5e Loaded Mini Patch Panel

### CAT5E 110-IDC Patch Panel

- Category-5E UL verified and listed patch panel
- High-reliability printed-circuit board design
- 110-termination 22-26 AWG tin-lead contact
- UL94V-0 black ABS modular jack banks
- Dual color-coded 568A/B wiring diagrams
- Numeric stencilled port ID labels



**310-324** 24-Port Cat5e Loaded Patch Panel

### CAT5E 110-IDC Patch Panel

- Category-5E UL verified and listed patch panel
- High-reliability printed-circuit board design
- 110-termination 22-26 AWG tin-lead contact
- UL94V-0 black ABS modular jack banks
- Dual color-coded 568A/B wiring diagrams
- Numeric stencilled port ID labels

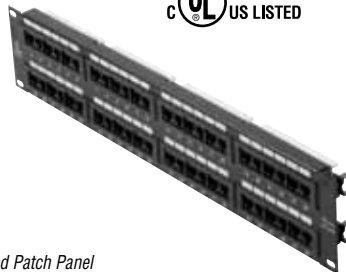

**310-348** 48-Port Cat5e Loaded Patch Panel

### CAT5E 110-IDC Patch Panel

- Category-5E UL verified and listed patch panel
- High-reliability printed-circuit board design
- 110-termination 22-26 AWG tin-lead contact
- UL94V-0 black ABS modular jack banks
- Dual color-coded 568A/B wiring diagrams
- Numeric stencilled port ID labels

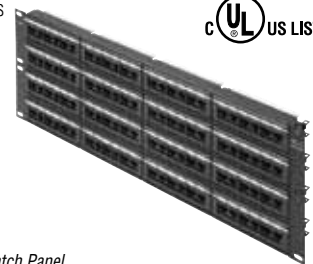

**310-356** 96-Port Cat5e Loaded Patch Panel

### Fast Media™ CAT6 Patch Panel

- Category-6 UL/cUL verified and listed
- High-reliability printed circuit board design
- 110-Termination 22-26 AWG tin-lead contact
- UL94V-0 black ABS modular jack banks
- Dual color-coded 568A/B wiring diagrams
- Numeric stencilled port ID labels



**310-334** 24-Port Cat6 Loaded Patch Panel

### Fast Media™ CAT6 Patch Panel

- Category-6 UL/cUL verified and listed
- High-reliability printed circuit board design
- 110-Termination 22-26 AWG tin-lead contact
- UL94V-0 black ABS modular jack banks
- Dual color-coded 568A/B wiring diagrams
- Numeric stencilled port ID labels

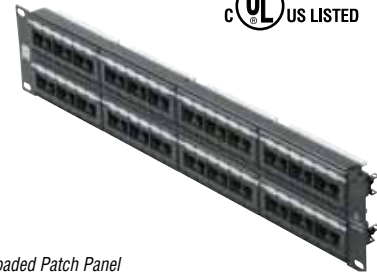

**310-349** 48-Port Cat6 Loaded Patch Panel

### Fast Media™ CAT6 Patch Panel

- Category-6 UL/cUL verified and listed
- High-reliability printed circuit board design
- 110-Termination 22-26 AWG tin-lead contact
- UL94V-0 Black ABS modular jack banks
- Dual color-coded 568A/B wiring diagrams
- Numeric stencilled port ID labels

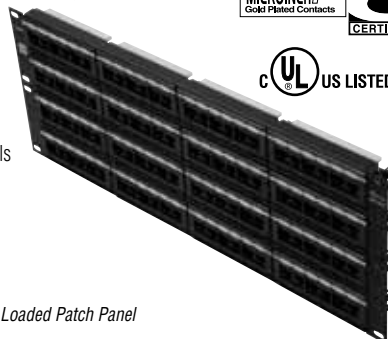

**310-358** 96-Port Cat6 Loaded Patch Panel

### Snap-In Patch Panel

- Unloaded panels suitable for any combination of coaxial, twisted-pair or fiber connectors
- Holds industry standard modular keystone inserts for custom installations
- Numeric stencilled port ID labels
- Use with Keystone series modules

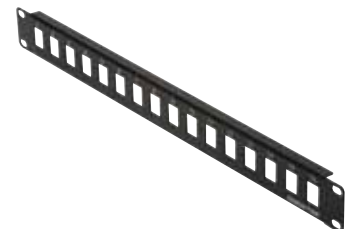

**310-216** 16-Port Blank Keystone Patch Panel



## CUSTOM NETWORKING

### Patch Panels

#### Snap-In Patch Panel

- Unloaded panels suitable for any combination of coaxial, twisted-pair or fiber connectors
- Holds industry standard modular Keystone inserts for custom installations
- Numeric stencilled port ID labels
- Use with keystone series modules

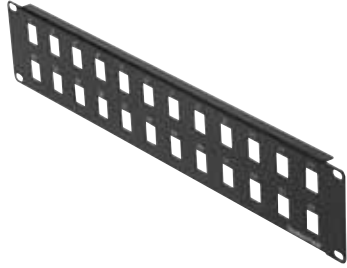

**310-224** 24-Port Blank Keystone Patch Panel

#### Hinged Wall Mount Bracket

- Wall mount bracket used for a 24 or 48 port panel
- 19" Standard width - EIA unit spacing compliant

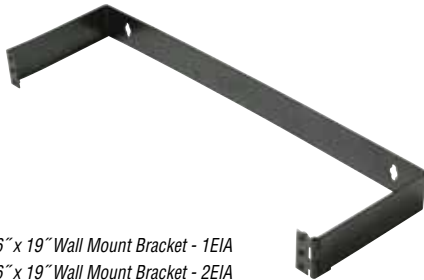

**310-601** 1-3/4" x 6" x 19" Wall Mount Bracket - 1EIA  
**310-602** 3-1/2" x 6" x 19" Wall Mount Bracket - 2EIA

#### 50-Pair Wiring Block

- 50-Pair Modular 110-IDC Wiring Block
- Flame retardant thermoplastic construction
- 110-IDC Terminals
- Terminates solid copper wire Category-3 24 AWG to Category-6 23 AWG
- Mounting bracket included



**310-368** 110-Type 50-Pair Wiring Block

#### Bridging Clip

- Bridging Clip for 66-IDC Wiring Block
- Nickel-Plated Brass Construction
- Dimensions: 1/2" (W) x 1/3" (H)
- Bags of 100



**310-372** 66-Type Bridging Clips for 310-366

#### Cable Management Panel

- 5-Ring low-profile cable manager
- Organizes front-rack patch cords for use on standard racks, wall brackets or cabinet installations
- Five 1 1/2"x4" horizontal plastic rings
- Some assembly required
- 1 x EIA Unit 19"(W) x 1 3/4"(H)

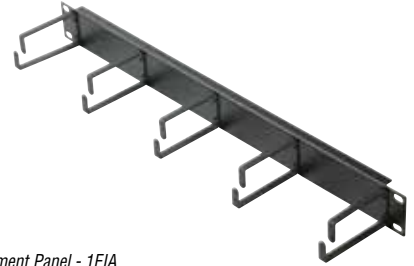

**310-399** Wire Management Panel - 1EIA

#### 50-Pair Wiring Block

- 50-Pair modular 66-IDC wiring block
- Flame retardant thermoplastic construction
- Quick-connect 66-IDC terminals
- Terminates solid copper wire Category-3 24 AWG to Category-6 23 AWG



**310-366** 66-Type 50-Pair Wiring Block

#### Mounting Bracket

- Mounting Bracket for 50-Pair Modular 66-IDC Wiring Block
- Flame Retardant Thermoplastic Construction

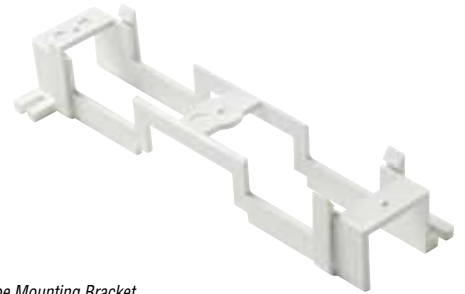

**310-367** 66-Type Mounting Bracket

#### Cable Distribution "D" Ring

- Suitable for use in cable terminals, ceilings, floors, walls, backboards and other surfaces
- Die-cast aluminum construction
- Smooth, rounded edges prevent damage to insulation and jackets



**310-390** 1-7/8" Cable Distribution Ring  
**310-392** 3-1/8" Cable Distribution Ring  
**310-394** 5-1/8" Cable Distribution Ring



ne fasthome™ **fasthome™** fasth





### FastHome™ Network Module

- Mount splitters, multiswitches, couplers and other devices
- Dimensions: 6 1/2" (W) x 2 3/4" (H)



**550-001** FastHome™ Universal Mount Plate

### FastHome™ Network Module

- Distributes 4 incoming phone, fax or modem lines to 6 rooms
- Combines, distributes 2 incoming cable TV lines to 6 rooms
- RJ31X Port for security system priority
- Expandable CAT5E phone hub
- Includes 9 VDC 300mA power adapter
- CATV input frequency 5-900 MHz
- Dimensions: 6 1/2" (W) x 4 3/4" (H) x 1" (D)



**550-010** FastHome™ Telephone/TV Hub Module

### FastHome™ Network Module

- Distributes 4 incoming phone, fax or modem lines to 6 rooms
- RJ31X port for security system priority
- Expandable CAT5E phone hub
- Dimensions: 6 1/2" (W) x 2 7/8" (H) x 1" (D)



**550-020** FastHome™ Telephone Hub Module

### FastHome™ Network Module

- Centrally terminates data wires from 8 locations for distribution to switches, hubs or routers
- Dimensions: 6 1/2" (W) x 2 7/8" (H) x 1" (D)



**550-030** FastHome™ Data Hub Module

### FastHome™ Network Module

- Combines, distributes 2 incoming cable TV lines to 6 rooms
- Includes 9VDC 300mA power adapter
- CATV input frequency 5-900 MHz
- Dimensions: 6 1/2" (W) x 2 7/8" (H) x 1" (D)



**550-040** FastHome™ TV Combiner/Splitter Module

### FastHome™ Network Module

- High-speed access - slide switch uplink
- Auto-negotiation on all ports
- Supports network IEEE 802.3/802.3u standards (10/100Mbps)
- Includes 12VDC 500mA power adapter
- Dimensions: 6 1/2" (W) x 2 7/8" (H) x 1" (D)



**550-060** FastHome™ Ethernet Switch Module

### FastHome™ Network Module

- Provides central 120VAC power for FastHome™ modules
- Features UL listed NEMA 5-15R duplex receptacle (125V, 15A, 2-pole, 3-wire)
- Dimensions: 6 1/2" (W) x 2 7/8" (H) x 1" (D)



**550-070** FastHome™ AC Power Module

**Contact your  
Stereon Representative  
for more information**

**Phone: (800) 266-3333**



### FastHome™ Network Enclosure

- Standard hole spacing allows flexibility for mounting FastHome™ or similar modules
- White textured powder-coated corrosion-resistant finish
- Mounts between 16" center wall studs
- Multiple knockouts and pre-punched holes
- Raised mounting rails create a clean wiring channel behind mounted module
- Captured hinge cover design for easy access
- Keyed latch for positive closure and security



550-200



550-205



550-210

**550-200**  
**550-205**  
**550-210**

FastHome™ In-Wall Mount Enclosure - 19"  
FastHome™ In-Wall Mount Enclosure - 32"  
FastHome™ In-Wall Mount Enclosure - 44"

### FastHome™ Network Enclosure

- Standard hole spacing allows flexibility for mounting FastHome™ or similar modules
- White textured powder-coated corrosion-resistant finish
- Mounts on surface of a wall
- Multiple knockouts and pre-punched holes
- Raised mounting rails create a clean wiring channel behind mounted module
- Captured hinge cover design for easy access
- Keyed latch for positive closure and security



550-100



550-105

**550-100**  
**550-105**

FastHome™ Surface Mount Enclosure - 11"  
FastHome™ Surface Mount Enclosure - 19"





tools

& meters **tools & meters** tools



tools & meters



**Compression Termination Tool** PermaSeal™

- Universal F-fitting compression tool
- Red rubberized grip handles
- Dimensions: 3"(W) x 8 1/2"(H) x 1"(D)

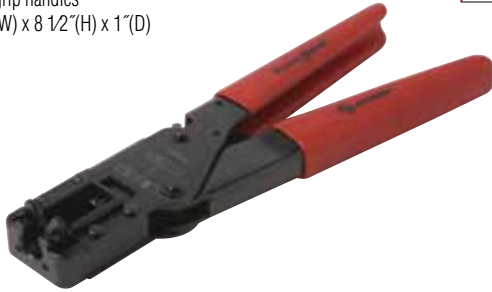

**204-001** Coax Compression Tool

**Compression Termination Tool** PermaSeal™

- Universal RG11 compression tool
- Terminates F fittings
- Built-in cable cutter
- Yellow/black rubberized grip handles
- Dimensions: 2"(W) x 9"(H) x 1"(D)



**204-031** Compression Tool RG11 F  
**204-034** 3-Piece Die Set for 204-036 and 204-031

**Compression Termination Tool** PermaSeal™

- Universal compression tool
- Terminates F, RCA, and BNC fittings
- Built-in cable cutter
- Yellow/black rubberized grip handles
- Dimensions: 2"(W) x 9"(H) x 1"(D)



**204-036** Compression Tool RG6/59 F/BNC/RCA  
**204-034** 3-Piece Die Set for 204-036 and 204-031

**Crimp Termination Tool**

- 3-Cavity hex crimp tool for RG58, RG59 and RG62 coaxial fittings
- Hex die 0.256", 0.213", 0.068"
- Full-cycle ratchet mechanism
- Yellow grip handles
- Dimensions: 2 1/2"(W) x 8 1/2"(H) x 3/4"(D)

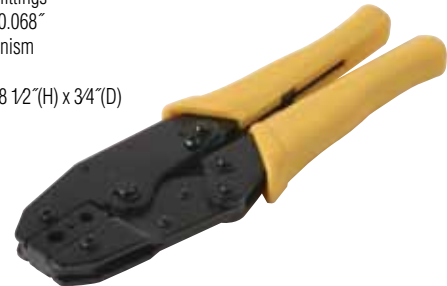

**204-004** 9" 3-Die Hex Crimp Tool

**Crimp Termination Tool**

- 4-Cavity hex crimp tool for RG58, RG59, RG62, RG6 coaxial fittings
- Hex Die 0.319", 0.256", 0.213", 0.068"
- Full-cycle ratchet mechanism
- Red grip handles
- Dimensions: 2 1/2"(W) x 8 3/4"(H) x 3/4"(D)



**204-005** 9" 4-Die Hex Crimp Tool

**Crimp Termination Tool**

- 2-Cavity hex crimp tool for RG59, RG62, and RG6 coaxial fittings
- Hex die 0.319", 0.256"
- Red grip handles
- Dimensions: 3"(W) x 9"(H) x 3/4"(D)



**204-007** 9" 2-Die Hex Crimp Tool

**Crimp Termination Tool**

- 2-Cavity hex crimp tool for RG59, RG6 universal and RG11 fittings
- Hex Die 0.480", 0.362"
- Blue grip handles
- Dimensions: 2 1/2"(W) x 8 3/4"(H) x 3/4"(D)



**204-009** 9" 2-Die Hex Crimp Tool

**Economy Crimp Tool**

- 2-Cavity hex economy crimp tool
- Suitable for RG59, RG62 and RG6 fittings
- Black grip handles
- Dimensions: 2"(W) x 8"(H) x 3/4"(D)



**204-011** Coax Crimping Tool



## AUDIO/ VIDEO

Cable Preparation Tools / Security Tools / Fiber Tools

### Cable Preparation Tool

- Precision coaxial cable stripper for RG58, RG59, RG62 and RG6
- Clothespin-style
- Fixed 3-blade construction
- Slide cable selection
- High-impact ABS plastic construction



**204-200** 3-Blade Clothespin Coax Stripper

### Cable Preparation Tool



- Precision coaxial cable stripper for RG58, RG59, RG62 and RG6
- Thumb wind-style
- Adjustable 2 or 3-blade construction
- High-impact ABS plastic construction



**204-202** 3-Blade Rotary Coax Stripper

### Cable Preparation Tool

- Precision coaxial cable stripper for RG58, RG59, RG62 and RG6
- Thumb-wind style
- Adjustable 2-blade construction
- High-impact ABS plastic construction



**204-205** Coax Stripping Tool



### Cable Preparation Tool

- Economy rotary coaxial cutter-stripper for RG58, RG59, or RG6
- Diameters 0.19"-0.30"
- Requires no blade adjustment



**204-300** Coax Cable Stripper Economy

### Cable Preparation Tool

- Coaxial cable cutter-stripper for RG59 and RG6
- Comfort molded grip plastic handles
- Sharp long-life hardened steel blades
- Integrated jacket and core stripper
- Integrated quick connector crimper
- Hardened carbon steel frames
- Red grip handles
- Weight: 4-oz.
- Dimensions: 1 3/4"(W) x 6"(H) x 1/4"(D)



**204-350** Coaxial Cable Cutter & Stripper



### Security Tool

- Security shield tool
- Precision machined nickel-plated
- Steel construction
- 7/16" Socket ensures even pressure
- Sure grip-end and clip ring
- Suitable for use with 200-966 and 200-968 security sleeves



**204-400** Security Shield Tool

### Fiber Preparation Tool

- Fiber optic cable cutter
- Wedge-shaped diamond tip for precise scribing and snapping of fiber steel chromate pen with pocket clip
- Dimensions: 3/8"(Dia.) x 5 3/16"(H)



**514-013** Precision Fiber Optic Fiber Cutter

**Contact your  
Steren Representative  
for more information**

**Phone: (800) 266-3333**



### Modular-Plug Crimp Tool

- Economy tool for handset and RJ11 plugs
- Suitable for 4x4 and 6x4 plugs
- Built-in cutting-stripping blade
- Plastic handles
- Dimensions: 3 3/4"(W) x 7 3/4"(H) x 5/16"(D)



**300-504** RJ11 Crimping Tool

### Modular-Plug Crimp Tool

- Economy tool for handset, RJ11, RJ45 plugs
- Suitable for 4x4, 6x4, 8x8 Plugs
- Built-in cutting-stripping blade
- Plastic handles
- Dimensions: 4 1/4"(W) x 7 1/2"(H) x 1"(D)



**300-508** Modular Plug Crimp Tool RJ11/45

### Modular-Plug Crimp Tool

- Crimp tool for handset plugs
- Suitable for 4x4 plugs
- Hardened steel
- Black-oxide finish
- Built-in cutting-stripping blades
- Blue grip handles
- Dimensions: 2 3/4"(W) x 7 1/2"(H) x 3/4"(D)

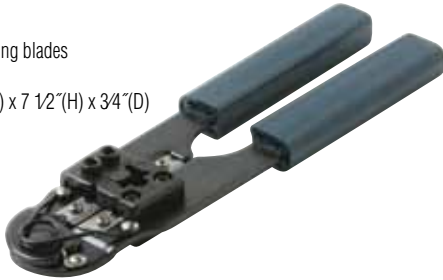

**300-552** Modular Plug Crimp Tool Handset

### Modular-Plug Crimp Tool

- Crimp tool for RJ11 and RJ12 plugs
- Suitable for 6x4 and 6x6 plugs
- Hardened steel
- Black-oxide finish
- Built-in cutting-stripping blades
- Blue grip handles
- Dimensions: 2 1/2"(W) x 7 1/2"(H) x 5/16"(D)



**300-555** Modular Plug Crimp Tool RJ11/12

### Modular-Plug Crimp Tool

- Crimp tool for RJ45 plugs
- Suitable for 8x8 plugs
- Hardened steel
- Black-oxide finish
- Built-in cutting-stripping blades
- Black grip handles
- Dimensions: 2 1/2"(W) x 8"(H) x 1"(D)

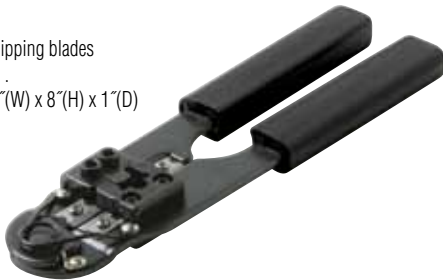

**300-558** Modular Plug Crimp Tool RJ45

### Modular-Plug Crimp Tool

- Crimp tool for RJ11, RJ12 and RJ45
- Suitable for 6x4, 6x6 and 8x8 plugs
- Hardened steel
- Black-oxide finish
- Built-in cutting-stripping blades
- Blue grip handles
- Dimensions: 3"(W) x 7 1/2"(H) x 1"(D)

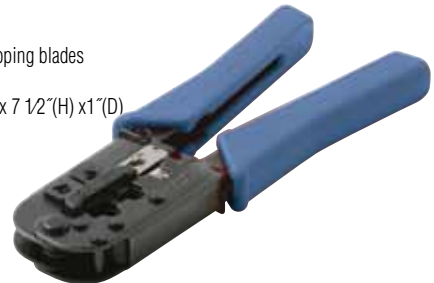

**300-568** Modular Plug Crimp Tool RJ11/12/45

### Modular-Plug Crimp Tool

- Ratchet crimp tool for RJ11, RJ12, RJ45
- Suitable for 6x4, 6x6, 8x8 plugs
- Precise, repeatable terminations
- Hardened steel
- Black oxide finish
- Built-in cutting-stripping blades
- Blue grip handles
- Dimensions: 2 3/4"(W) x 8 1/2"(H) x 1"(D)

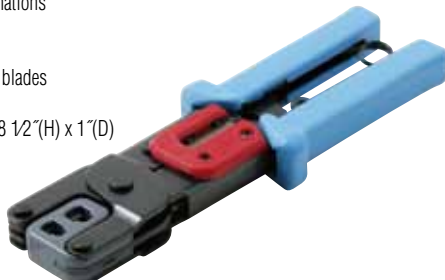

**300-574** Modular Plug Crimp Tool RJ11/12/45

**Contact your  
Stereon Representative  
for more information**

**Phone: (800) 266-3333**



## DATACOM / TELEPHONY

### Punch-Down Tools / Punch-Down Blades / D-Sub Installation Tool

#### Punch-Down Tool

- Impact punch-down tool
- Spring-loaded adjustable impact
- Terminates and cuts conductors on 110/88 or 66 blocks
- Spare blade storage compartment
- Blades supplied separately



**300-650** IDC Impact Punch-Down Tool

#### Punch-Down Tool

- Punch-down tool with hook
- Spring-loaded adjustable impact
- Terminates and cuts conductors on 110/88 or 66 Blocks
- Spare blade storage compartment
- Blades supplied separately



**300-653** IDC Impact Punch-Down Tool w/Hook

#### Punch-Down Tool

- Disposable punch-down tool
- Inexpensive
- Suitable for small jobs
- Terminates conductors on 110 blocks



**300-657** IDC Punch-Down Tool Disposable

#### Punch-Down Tool

- 5-Pair 110-blade punch-down tool
- Impact tool terminates wires on 110 punch-down block
- 5-Pair head seats up to 10 wires with one motion
- Reversible blade allows cutting and terminating wires, or terminating only
- Heavy-duty, easy-grip, no-slip handle



**300-685** 110 5-Pair Punch-Down Tool

#### Punch-Down Blade

- Reversible punch or punch-and-cut
- Used with 300-650 tool



300-670

300-675

**300-670** 66 Punch-Down Blade

**300-675** 110/88 Punch-Down Blade

#### Punch-Down Blade

- Reversible punch or punch-and-cut
- Used with 300-653 tool



300-672

300-677

**300-672** 66 Punch-Down Blade

**300-677** 110/88 Punch-Down Blade

#### D-Sub Installation Tool

- D-Sub pin-insertion/extraction tool



**500-200** D-Sub Pin Insert/Extract Tool

#### D-Sub Installation Tool

- D-sub crimp tool
- Suitable for D-sub contacts and 22-28 AWG butt-connectors
- Hardened steel construction
- Cushion-grip handles



**500-210** D-Sub Crimping Tool



### Test Probes

- 3' Banana plugs to test-probes



**601-500** 3' Repl Test Leads Banana Plug

### Digital Multimeter

- 3 1/2-Digit digital multimeter
- 1/2" LCD display
- 20-Position rotary range-switch
- Diode and transistor tester
- Overload protected
- Transistor tester 1.5mA max.
- Voltage 200mV-1000V DC  $\pm 0.5\%$
- Voltage 200-750V AC  $\pm 1.2\%$
- Current 200 $\mu$ A-10A DC  $\pm 1\%$
- Resistance 200 $\Omega$ -2M $\Omega$   $\pm 8\%$
- High-visibility yellow case
- Includes 30" test leads and 9V battery
- Dimensions: 2 5/8"(W) x 4 7/8"(H) x 1"(D)



**602-010** LCD Digital Multimeter

### Digital Multimeter

- 3 1/2-Digit adjustable-display DMM
- 1" High-contrast LCD display
- 30-Position rotary range-switch
- Diode and 50 $\Omega$  continuity beeper
- Overload protected – data-hold switch
- Transistor tester 10 $\mu$ A 3.4V
- Voltage 200mV-1000V DC  $\pm 0.5\%$
- Voltage 200mV-700V AC  $\pm 0.8\%$
- Input impedance 10-100M $\Omega$
- Current 200 $\mu$ A-10A DC  $\pm 0.8\%$
- Current 200 $\mu$ A-10A AC  $\pm 1\%$
- Capacitance 2nF-20 $\mu$ F  $\pm 2.5\%$
- Resistance 200 $\Omega$ -20M $\Omega$   $\pm 8\%$
- 36" 1500V Double-insulated test leads
- Yellow injection molded tuff case
- Includes leatherette case and 9V battery
- Dimensions: 3 3/4"(W) x 7 3/4"(H) x 15/8"(D)



**602-040** Auto/Manual LCD Digital Multimeter

### Digital Multimeter

- 3 1/2-Digit pocket DMM
- 3/4" LCD Display
- Diode and 50 $\Omega$  continuity beeper
- Overload protected
- Voltage 2-500V DC  $\pm 0.5\%$
- Voltage 200-500V AC  $\pm 1.2\%$
- Input impedance 1M $\Omega$
- Current 200mA DC  $\pm 1.5\%$
- Resistance 2k $\Omega$ -2M $\Omega$   $\pm 1.0\%$
- 18" Wrap-around test leads
- Includes leatherette pouch, 9V battery
- Dimensions: 2 3/4"(W) x 4 3/4"(H) x 3/4"(D)



**602-070** Pocket Size LCD Digital Multimeter

### Digital Clamp Multimeter

- 3 3/4-Digit mini clamp-on amp Meter
- Digital and analog backlight LCD display
- 42-Segment fast analog bar graph
- Display and audio continuity test
- Diode test – auto Power off
- Auto and manual range – data hold
- Voltage 0-600V DC  $\pm 1.0\%$
- Voltage 0-600V AC  $\pm 1.5\%$
- Current: AC 40-400A  $\pm 2.0\%$
- Resistance 400 $\Omega$   $\pm 1.0\%$
- 18" Test leads – includes AAA batteries
- Includes black carrying case
- Includes dust-proof wrist strap
- Dimensions: 2 3/4"(W) x 7 1/2"(H) x 1 1/4"(D)



**602-115** 3 3/4 Mini Autorange Digital Multimeter

### Digital Multimeter

- 3 3/4-Digit auto-range DMM
- 5/8" High contrast LCD display
- 33-Segment fast analog bargraph
- Diode and 50 $\Omega$  continuity beeper
- Manual range-override switch
- Overload protected – data hold switch
- Transistor tester 10 $\mu$ A 3.2V
- Frequency 32.6-200kHz  $\pm 1.2\%$
- Capacitance 326nF-32.6 $\mu$ F  $\pm 3.0\%$
- Voltage 326mV-1000V DC  $\pm 0.3\%$
- Voltage 326mV-750V AC  $\pm 0.8\%$
- Input impedance 10-100M $\Omega$
- Current 326 $\mu$ A-10A DC/AC  $\pm 1.5\%$
- Resistance 326 $\Omega$ -32.6M $\Omega$   $\pm 0.8\%$
- Yellow injection molded tuff case
- 36" 1500V Double-insulated test leads
- Includes tilt stand, holster, 9V battery
- Dimensions: 3 3/4"(W) x 7 3/4"(H) x 1 1/2"(D)



**602-270** Auto-Range LCD Digital Multimeter

### Inductive Voltage Detector

- Non-contact inductive voltage detector
- Senses 100-240VAC within 2" range
- Emits audible tone and flashing light
- 2 AAA Batteries included
- Dimensions: 3 4/4"(W) x 5 3/4"(H) x 1"(D)



**602-805** 100-240V AC Voltage Detector

### Cable Locator

- Cable locator tone-test set
- Amplifier probe and tone generator
- Helps locate, identify, trace cable-pairs, individual conductors in non-energized electrical, CATV, data, telephone and security cabling
- Includes 9V batteries and nylon holster
- Display packaged for resale



**602-810** Tone & Probe Line Tracer Kit



## METERS / TEST EQUIPMENT

### Satellite Finders / Meters

#### Satellite Finder Meter

- Highly sensitive meter
- Built-in buzzer with pitched tone for alignment reference
- Front panel sensitivity control
- RF and DC pass-through – 75Ω 950-2050MHz input
- Sensitivity 7mV@55dB – LNB gain 3-carrier C/N 15dB
- Input level -25 to -75dBm – LNB gain 52-60dB
- Power requirements 13-18VDC
- Requires 6dB attenuator for 60-65dB LNB gain



200-992



200-993

**200-992**

Analog Pocket Satellite Finder

**200-993**

LED Bar-Graph Pocket Satellite Finder

#### Dual Satellite Signal Level Meter

- Dual satellite signal level meter
- Simultaneously monitors two satellite LNBs
- Provides accurate alignment of altitude, elevation and tilt-skew
- Amplified broadband detector and variable gain controls allow detection of wide range of input levels
- Audio tones enable rough signal detection
- Meter deflection for precise acquisition
- Meters can be independently switched between level, current, voltage and 22kHz tone
- Frequency range 950-2150MHz
- Impedance 75Ω – insertion loss 4.5dB
- Internal rechargeable battery 100mA 11hrs
- Battery life 500 charge/discharge cycles
- Includes 24VDC 100mA transformer
- Includes custom carrying case
- Dimensions: 7 1/2"(W) x 5 7/8"(H) x 5 1/4"(D)
- Weight: 3.0 lbs.



**203-510**

Satellite Dual-Signal Level Meter

#### SkyTracker™ Signal Meter

- SkyTracker™ plus single-LNB meter
- LED and audio indicators
- Identifies DiSEqC and 22kHz
- Powered by receiver or DC supply
- Meter ranges 10-20V, 0-500mA
- Input level 20-100 dBμV
- Dimensions: 5 3/4"(W) x 2 1/4"(H) x 3/4"(D)

**SKY PRO TRACKER™**



**203-620**

Skytracker Plus Satellite Meter

#### SkyTracker™ Signal Meter

- SkyTracker™ pro dual-LNB meter
- Measures 2 LNBs simultaneously
- LCDs and selectable On/Off Tone
- Identifies DiSEqC, 22kHz, 13/18V, mA
- Can be set up as a two-way switch
- Runs DiSEqC 1.2/Sat scan actuator
- Transmits 22 kHz, DiSEqC to LNB
- Powered by receiver or DC supply
- Meter ranges 0-30V, 0-900mA
- Input level 20-100 dBμV
- Optional carrying case and battery
- Dimensions: 5 3/4"(W) x 2 1/4"(H) x 3/4"(D)



**203-630**

Sky Tracker Pro Satellite Meter

#### SkyTracker™ Satellite Meter

- SkyTracker™ Pro II dual LNB digital satellite meter
- Built-in 22kHz tone generator to control multiswitches
- Graphical LCD bar scale, numerical indicator or variable audio tone
- Signal strength readout
- Power consumption 40mA, with audible tone 50mA
- Overload protection with LNB current draw limiter
- Dimensions: 5 5/8"(W) x 2 1/4"(H) x 1 3/16"(D)

**SKY PRO TRACKER™**



**203-622**

Skytracker Pro II Satellite Meter Kit

#### SkyTracker™ Satellite Meter

- SkyTracker™ plus single LNB digital satellite meter
- Graphical LED scale or variable
- Audio tone signal strength readout
- Power consumption 10mA, with audible tone 25mA
- Dimensions: 5 7/8"(W) x 2 1/4"(H) x 1 3/16"(D)

**SKY PRO TRACKER™**



**203-621**

Skytracker Plus Satellite Meter Kit

#### Satellite Clinometer Tool

- Compass/Clinometer tool for accurate sight surveys and satellite antenna installations
- Clinometer in degrees and percentage for evaluation, slopes and heights
- Compass for azimuth readings with reverse scale to prevent error
- Protective carrying case
- Easy to read measurement cards with smooth operation
- Adjustable eyepieces

**NEW**



**203-661**

Combination Compass/Clinometer Tool

#### SkyTracker™ Signal Meter

- SkyTracker™ accessories kit
- Rechargeable external battery pack
- AC and car cigarette lighter adapter
- 6' RG6 quick connect patch cable
- Leather carrying case and strap
- Compartment for 203-620 or 203-630
- Dimensions: 9 1/2"(W) x 4 5/8"(H) x 1 7/8"(D)

**SKY PRO TRACKER™**



**203-635**

SkyTracker Accessories Kit

**203-640**

SkyTracker Pro II Satellite Meter





### SkyTracker™ Satellite Finder

- SkyTracker™ beeper satellite finder
- Suitable for RV with satellite dish
- Automatic attenuation adjustment
- Pitch tone indicator – includes earbud



**203-650** SkyTracker Satellite Finder

### Cable Continuity Tester

- Pocket toner
- Batteries included



**203-550** Pocket Toner

### Cable Continuity Tester

- Pocket toner test kit
- Includes F, RCA, BNC, RJ11 and RJ45 adapters
- Toner and adapters fit into slots inside durable carrying case



**203-560** Pocket Toner Test Kit

### Network Cable Tester

- 4-Pair twisted pair and coaxial cable tester
- Tests local or installed cable
- Removable RJ45-BNC remote unit
- Provides instant diagnosis of 4-Pair twisted-pair and coax for continuity, opens, shorts, miswires, crossed, reversed, transposed and split-pairs
- LEDs visually indicate good/faulty connections
- Includes 9V battery
- Display boxed for resale



**300-100** Ethernet Cable Tester RJ45 and BNC

### Alligator Clips

- Alligator clips



**258-101** 1" Alligator Clip, BK / RD  
**258-103** 2 1/2" Alligator Clip, BK / RD

### Alligator and Battery Clip

- 3" 30A Battery clamp



**258-661** 3" 30-Amp Battery Clamp, BK/RD

### Alligator and Battery Clip

- 4" 9-Volt battery clip connector
- 24 AWG stripped-tinned leads



**258-810** 9V Battery Clip Connector

**Contact your  
 Steren Representative  
 for more information**

**Phone: (800) 266-3333**



## INSTALLATION / MISCELLANEOUS

### Tool Bags and Pouches / Miscellaneous Tools

#### Tool Bag and Pouch

- 15-Pocket tool bag with 16" tray compartment
- 7 Inside/8 outside pockets
- Extra padded carrying handles for strength and comfort
- Comfortable, adjustable shoulder strap
- Metal tool snap and electrical tape strap
- Two large side compartments with web loops for large-handle tool
- Tools and tray not included
- Dimensions: 16"(L) x 11"(W) x 10"(H)



**204-451** 15 Pocket Tool Bag

#### Tool Bag and Pouch

- 35-Pocket tool bucket bag
- 8 Inside/27 outside pockets
- Fits inside standard 5-Gal. bucket
- Large interior pockets and room for big tool, spray cans, etc.
- Inside loop keeps hammer in place
- Outside loop can dispense tape without removing roll
- Includes shallow outside pockets for drill bits and screws
- Tools and bucket not included
- Dimensions: 20"(L), fits 5-gal. bucket



**204-452** 35 Pocket Tool Bucket Bag

#### Tool Bag and Pouch

- 23-Pocket industrial tool bag
- 17 Inside/6 outside pockets
- Padded carrying handles for strength and comfort
- Foam-padded sides and reinforced bottom create semi-rigid framework
- Comfortable, adjustable shoulder strap
- Tools not included
- Dimensions: 16"(L) x 9"(W) x 9"(H)



**204-453** 23 Pocket Industrial Tool Bag

#### Tool Bag and Pouch

- 28-Pocket electrical and maintenance tool pouch
- 9 Inside/19 outside pockets
- Box-shaped design keeps pouch steady on flat surface
- Includes many pockets for tools, drill bits electrical tape, etc.
- Tools not included
- Dimensions: 9"(L) x 9"(W) x 18"(H)



**204-454** 28 Pocket Electric Tool Pouch

#### Alligator Clip Set

- 1" 10-Cable alligator clip lead set
- 1' 24 AWG color coded leads

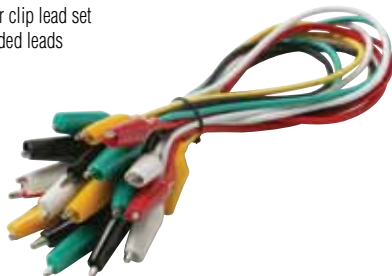

**259-101** 1" 10-Lead Alligator Clip Set

#### Alligator Clip Set

- 2 1/2" 5-Cable alligator clip lead set
- 2' 20 AWG color coded leads

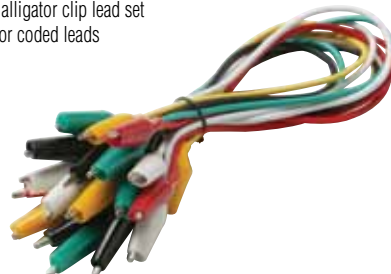

**259-103** 2 1/2" 5-Lead Alligator Clip Set



### Laser Level

- 16" Laser level
- Professional leveling tool
- Horizontal/vertical liquid level
- Convenient ruler in metric, english units
- Sliding cover selects line or dot projection
- Durable yellow aluminum frame
- Non-scratch machined bottom surface
- 1/4" Threaded tripod mounting hole
- Compliant with FDA standards
- Includes 2 AAA batteries
- Display packaged for resale

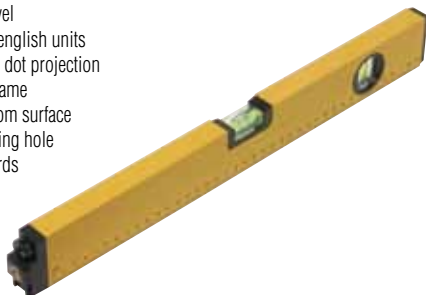

**203-606** 16" Laser Level

### Cable Caddy

- Cable caddy
- Increases ease and efficiency of installing cables
- Holds up to 1000' cable reels
- Folds neatly for storage and transport
- Light weight, durable steel construction
- Dimensions: 20"(W) x 12"(H) x 18 1/2"(D)



**204-407** Folding Cable Caddy

### Precision Stripper

- 5" Miniature adjustable stripper/cutter
- Suitable for 10-30 AWG wire
- Hardened-steel
- Dimensions: 1 1/2"(W) x 5"(H) x 3/16"(D)



**993-610** 5" Stripper-Cutter

### Plier/Cutter

- 5" Miniature precision flush cutter
- Display packaged for resale



**993-620** 5" Precision Flush Cutter

### Precision Stripper

- Precision stripper and cutter
- Suitable for 10-22 AWG wire
- Hardened-steel
- Dimensions: 2"(W) x 6 1/2"(H) x 3/8"(D)



**993-640** Wire Stripper & Cutter AWG 10-22

### Precision Stripper

- Precision Stripper/Cutter
- Suitable for 20-30 AWG Wire
- Hardened Steel - Weight 5oz
- Dimensions 2"(W) x 6 1/2"(H) x 3/8"(D)



**993-650** 5" Stripper-Cutter

### Precision Stripper

- Telecom cable stripper and cutter
- Suitable for 26 AWG-9.5m
- Cleanly Strips UTP, coax, flat cables
- Cable stops for precise strip lengths
- Replaceable blades
- High-impact ABS plastic construction
- Hardened-steel
- Dimensions: 2"(W) x 4 1/2"(H) x 1/2"(D)



**993-750** Universal Strip & Cut Tool

### Soldering Iron

- 30-Watt UL pencil soldering iron
- Bakelite Construction
- 1/8" Tip
- Display Packaged for Resale



**400-110** 30W Pencil Soldering Iron UL



## MISCELLANEOUS

### Miscellaneous Tools / Cable Preparation Tools

#### Soldering Iron

- Soldering station
- Electronic temperature regulation
- Adjustable dial range 300-700°F
- 48-Watt 24-volt
- Anti-static fully grounded
- LED-array temperature display
- Built-in tray with cleaning sponge
- Non heat-sinking spring funnel
- Nickel-plated iron-clad conical tip
- 117VAC Grounded 3-wire cord
- Display packaged for resale



**400-140** 48W Soldering Station

#### Soldering Iron

- Soldering iron stand
- Non heat-sinking spring funnel
- Cooling tray and sponge
- Display packaged for resale



**400-180** Pencil Soldering Iron Stand

#### Solder

- Solder tube dispenser
- 7", 18AWG 60/40 Rosin core



**400-150** 7' 60/40 Solder Dispenser Tube

#### Solder

- 1-lb Solder spool
- 18AWG 60/40 Rosin core



**400-155** 1-lb 60/40 Solder Spool

#### Desoldering Braid

- 5' x 0.1" Copper desoldering braid



**400-168** Desoldering Braid

#### Desoldering Pump

- Anti-static desoldering pump
- Aluminum-plastic construction
- Self-cleaning
- Rugged TFE tip
- Display packaged for resale



**400-170** Desoldering Pump



bulk cable **bulk cable** bulk

bulk o





**Economy Bulk Coaxial Cable**

- Economy grade RG59/U coaxial cable suitable for consumer applications and general RF signal transmission
- Supplied in 1000' spool

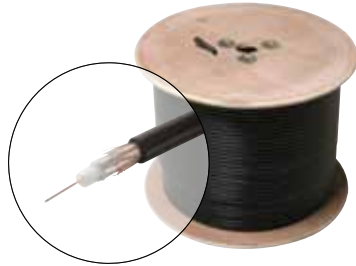

**200-910** 1000' RG59/U CCS Cable, BK

**Economy Bulk Coaxial Cable**

- Economy grade RG6/U coaxial cable suitable for consumer applications and general RF signal transmission
- 18AWG Center conductor
- Supplied in 1000' reels in box



**200-927** 1000' RG6/U CCS Cable, BK / WH

**Mini RG59**

- 500' Mini RG59 5-wire cable - stranded
- Maximum performance cables
- Sweep tested to 3GHz
- 25 AWG Stranded copper conductors
- Stranded copper braid, 95% coverage
- Red, green, blue, yellow, white
- PVC Insulation jackets
- UL Listed, NEC type CM
- Supplied in 500' Spool

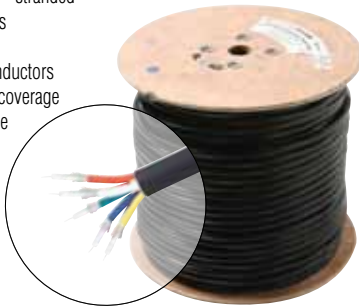

**200-925** 500' RG59 Mini 5-Wire CU, UL Cable, BK

**RG59 Siamese Cable**

- RG59 Siamese cable 95% shielded solid copper conductor
- 500' RG59 Coaxial CCTV-cam cable with 2-conductor power-limited cable
- Suitable for CCTV installations
- 20 AWG Solid copper center conductor
- Copper braid shield, 95% coverage
- 2-Conductor 18 AWG stranded copper
- Flame retardant PVC insulation
- UL Listed, NEC type CM, CL3
- Supplied in 500' spool



**200-915** 500' RG59 + 18/2 CCTV, UL Cable, BK, WH

**Bulk Coaxial Cable**

- High-grade RG6/U coaxial cable CCS
- Fully sweep tested to 3GHz
- 18 AWG
- Aluminum foil shield bonded to dielectric
- 60% Aluminum braid shield
- Flame retardant lead-free PVC jacket, foot-marked
- UV Inhibitor™ additive protects cable from sun damage
- Supplied in spool and reel in a box



**200-929** 1000' RG6/U CCS, UL Cable, BK, WH - Spool  
**200-931** 1000' RG6/U CCS, UL Cable, BK, WH - Reel in Box

**High-Grade Coaxial Cable**

- High-grade RG6/U coaxial cable solid copper conductor
- Fully sweep tested to 3GHz
- 18 AWG Solid conductor
- Aluminum foil shield bonded to dielectric
- 60% Aluminum braid shield
- Flame retardant lead-free PVC jacket, foot-marked
- UV Inhibitor™ additive protects cable from sun damage
- Supplied in spool and pull box

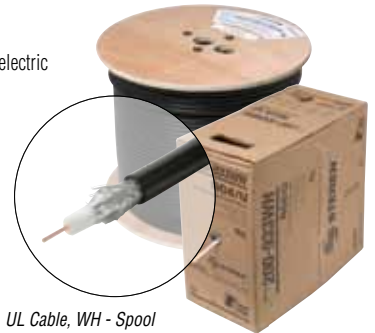

**200-932** 1000' RG6/U CU, UL Cable, WH - Spool  
**200-933** 1000' RG6/U CU, UL Cable, BK, WH - Pull Box

**High-Grade Quad Shield Coaxial Cable**



- High-grade RG6 quad shield coaxial cable dolid copper conductor
- Fully sweep tested to 3GHz
- 18 AWG solid conductor
- 60 + 40 Coverage
- Flame retardant lead-free PVC jacket, foot-marked
- UV Inhibitor™ additive protects cable from sun damage
- Supplied in spool



**200-936** 1000' RG6/Quad CU, UL Cable, BK, WH

**Quad Shield Coaxial Cable**



- High-grade RG6 quad shield coaxial cable copper clad steel conductor
- Fully sweep tested to 3GHz
- 18 AWG Solid conductor
- 60 + 40 Coverage
- Flame retardant lead-free PVC jacket, foot-marked
- UV Inhibitor™ additive protects cable from sun damage
- Supplied in reel in box



**200-937** 1000' RG6/Quad CCS, UL Cable, BK, WH



## COAXIAL / AUDIO

### Series-6 Coaxial Drop Cable

- High-grade dual RG6/U coaxial cable
- Suitable for digital HDTV applications, CATV and satellite
- Fully sweep tested to 3GHz
- 18 AWG solid conductors
- Aluminum foil shield bonded to dielectric
- Aluminum braid shield
- 17 AWG Copper-clad steel ground wire
- Flame retardant lead-free PVC jacket, foot-marked
- UV Inhibitor™ additive protects cable from sun damage
- Supplied in spool

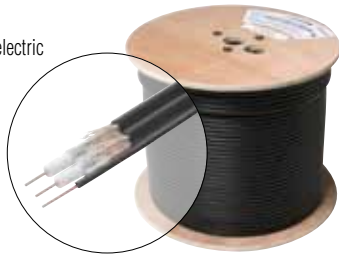

**200-939** 500' Dual RG6/U CU w/Ground UL Cable, WH

### Professional Grade Audio Cable

16 Gauge

- Professional-grade audio cable for exceptional performance
- Ideal for digital/analog speaker and home theater systems
- Multiconductor cable reduces need to pull multiple wires
- Superior quality stranded copper conductors
- High-strand-count wire for excellent audio signal transfer
- Color-coded flame retardant PVC insulation
- UL or ETL Listed – NEC type CL3
- Supplied in pull-boxes



**255-932** 500' 16AWG 2C Speaker Cable, BL, WH  
**255-934** 500' 16AWG 4C Speaker Cable, WH

### Professional Grade Audio Cable

18 Gauge

- Professional-grade audio cable for exceptional performance
- Ideal for digital/analog speaker and home theater systems
- Multiconductor cable reduces need to pull multiple wires
- Superior quality stranded copper conductors
- High-strand-count wire for excellent audio signal transfer
- Color-coded flame retardant PVC insulation
- UL or ETL Listed
- NEC type CL3
- Supplied in pull-boxes



**255-936** 500' 18AWG 2C Speaker Cable, WH

### High-Grade Bulk Speaker Cable

10 Gauge

- Ultra-flexible high-definition speaker cable
- Exceptional performance, sound quality for professional speaker and audio connections
- Dense, finely stranded parallel rope-lay
- 10 Gauge wire, high twist count
- Clear PVC jacket
- Blue polarity stripe
- Supplied in spool

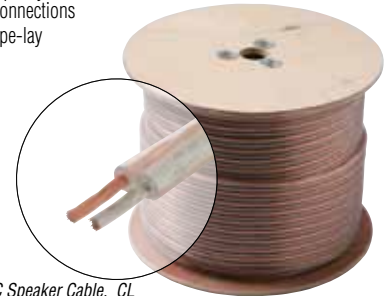

**255-510** 100' 10AWG 2C Speaker Cable, CL  
**255-510** 500' 10AWG 2C Speaker Cable, CL

### High-Grade Bulk Speaker Cable

12 Gauge

- Ultra-flexible high-definition speaker cable
- Exceptional performance, sound quality for professional speaker and audio connections
- Dense, finely stranded parallel rope-lay
- 12 Gauge wire, high twist count
- Clear PVC jacket
- Blue polarity stripe
- Supplied in spool

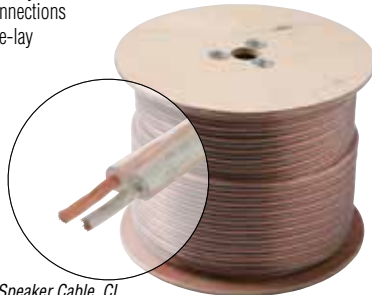

**255-513** 100' 12AWG 2C Speaker Cable, CL  
**255-413** 500' 12AWG 2C Speaker Cable, CL

### Bulk Speaker Cable

12 Gauge

- Standard application speaker cable
- Good performance and sound quality for most speaker and audio equipment connections
- Clear flexible PVC jacket
- Supplied in spool

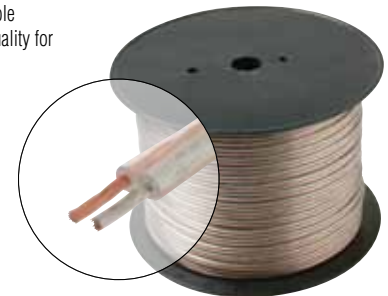

**255-712** 50' 12AWG 2C Speaker Cable, CL  
**255-512** 100' 12AWG 2C Speaker Cable, CL  
**255-412** 500' 12AWG 2C Speaker Cable, CL

### Bulk Speaker Cable

14 Gauge

- Standard application speaker cable
- Good performance and sound quality for most speaker and audio equipment connections
- Clear flexible PVC jacket
- Supplied in spool

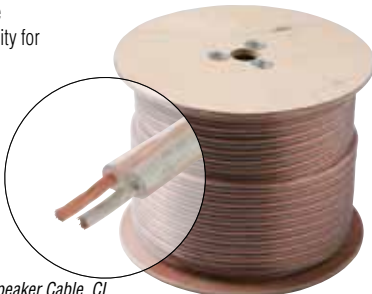

**255-714** 50' 14AWG 2C Speaker Cable, CL  
**255-514** 100' 14AWG 2C Speaker Cable, CL  
**255-414** 500' 14AWG 2C Speaker Cable, CL  
**255-314** 1000' 14AWG 2C Speaker Cable, CL

### Bulk Speaker Cable

16 Gauge

- Standard application speaker cable
- Good performance and sound quality for most speaker and audio equipment connections
- Clear flexible PVC jacket
- Supplied in spool

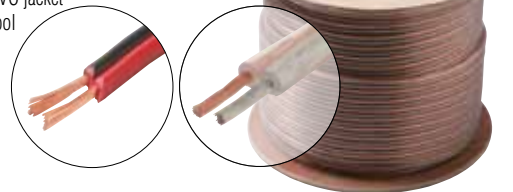

**255-516** 100' 16AWG 2C Speaker Cable, CL, RB  
**255-416** 500' 16AWG 2C Speaker Cable, CL  
**255-316** 1000' 16AWG 2C Speaker Cable, CL, RB





**Bulk Speaker Cable**

**18 Gauge**

- Standard application speaker cable
- Good performance and sound quality for most speaker and audio equipment connections
- Delivers fine quality sound in long runs
- Clear flexible PVC jacket
- Supplied in spool

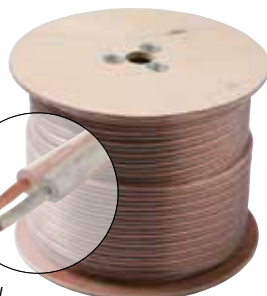

- 255-718** 50' 18AWG 2C Speaker Cable, CL
- 255-518** 100' 18AWG 2C Speaker Cable, CL
- 255-418** 500' 18AWG 2C Speaker Cable, CL
- 255-318** 1000' 18AWG 2C Speaker Cable, CL, RB

**Bulk Speaker Cable**

**20 Gauge**

- Standard application speaker cable
- Good performance and sound quality for most speaker and audio equipment connections
- Clear flexible PVC jacket
- Supplied in spool

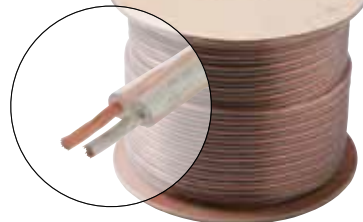

- 255-320** 1000' 20AWG 2C Speaker Cable, CL

**Bulk Speaker Cable**

**22 Gauge**

- Standard application speaker cable
- Good performance and sound quality for most speaker and audio equipment connections
- Clear flexible PVC jacket
- Supplied in spool

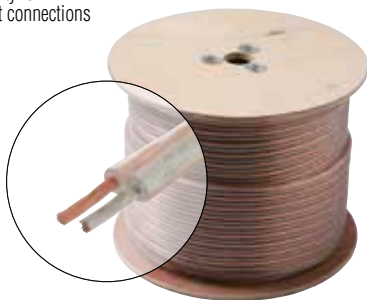

- 255-322** 1000' 22AWG 2C Speaker Cable, CL

**Coiled Bulk Speaker Cable**

**16 Gauge**

- Coiled, tied standard application speaker cable
- Good performance and sound quality for most speaker and audio equipment connections
- Clear flexible PVC jacket

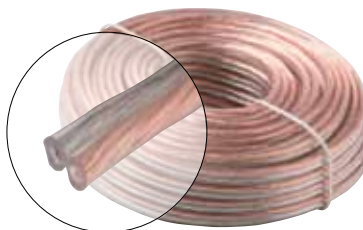

- 255-816** 25' 16AWG 2C Speaker Cable, CL

**Coiled Bulk Speaker Cable**

**16 Gauge**

- Coiled, tied standard application speaker cable
- Good performance and sound quality for most speaker and audio equipment connections
- Clear flexible PVC jacket

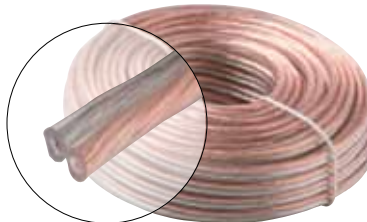

- 255-716** 50' 16AWG 2C Speaker Cable, CL

**Economy Speaker Cable**

**14 Gauge**

- Economy-grade speaker cable
- Acceptable performance for speaker and audio equipment connections
- Clear flexible PVC jacket
- Supplied in spool

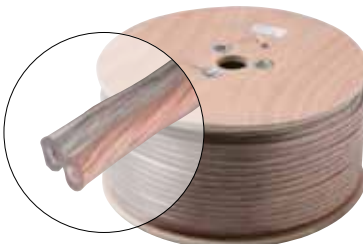

- 255-315** 1000' 14AWG 2C Economy Speaker Cable, CL

**Economy Speaker Cable**

**16 Gauge**

- Economy-grade speaker cable
- Acceptable performance for speaker and audio equipment connections
- Clear flexible PVC jacket
- Supplied in spool

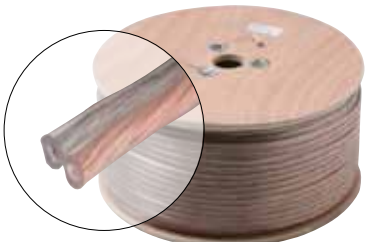

- 255-317** 1000' 16AWG 2C Economy Speaker Cable, CL

**Economy Speaker Cable**

**18 Gauge**

- Economy-grade speaker cable
- Acceptable performance for speaker and audio equipment connections
- Clear flexible PVC jacket
- Supplied in spool

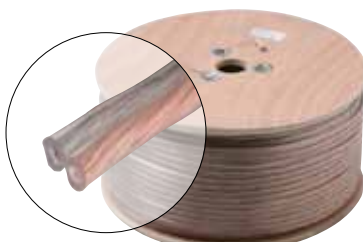

- 255-319** 1000' 18AWG 2C Economy Speaker Cable, CL



## AUDIO / TELEPHONY

### Bulk Microphone Cable

- High reliability, professional microphone cable
- Suitable for microphones, musical instruments and home entertainment
- 22 AWG Center conductors
- Low-loss copper shield
- 2-Conductor
- Black ultra-flexible rubber jacket
- Supplied in spool

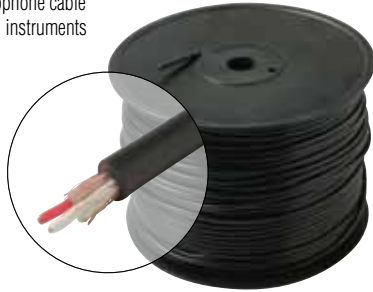

**256-210** 500' 2C Microphone Cable  
**256-220** 1000' 2C Microphone Cable

### Bulk Flat Modular Cable

- Flat modular cable – PVC jacket
- Suitable for telephone, VoIP telephony applications
- 28 AWG Stranded conductors
- Supplied in spool

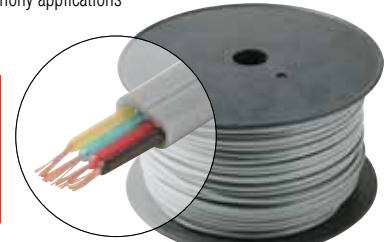
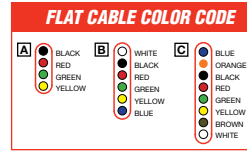

**300-840** 1000' 4C Flat Modular Cable, BK, IV, SL, [A]  
**300-860** 1000' 6C Flat Modular Cable, IV, SL, [B]  
**300-880** 1000' 8C Flat Modular Cable, SL, [C]

### Bulk Flat Modular Cable

- UL Listed flat modular cable – PVC jacket
- Suitable for Telephone, VoIP telephony applications
- 26 AWG Stranded conductors
- Supplied in spool

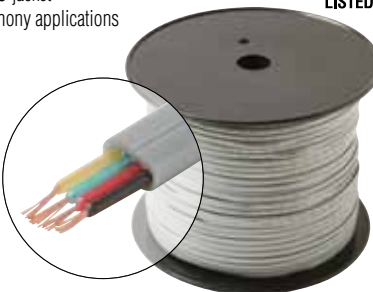
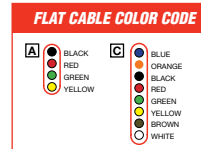

**301-840** 1000' 4C Flat Telephone Cable UL, SL, [A]  
**301-880** 1000' 8C Flat Telephone Cable UL, SL, [C]

### Bulk Round Station Wire

- Suitable for single-line telephone and intercom/PA systems
- 24 AWG Solid conductors
- 4 Conductor or 6 conductor – non-twisted pair
- Color-Coded, unshielded – beige PVC jacket
- 1000' Lengths
- Supplied in spool and pull box

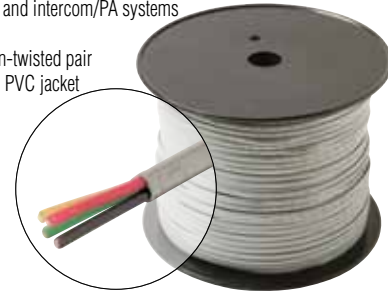

**300-741** 1000' 4C Solid Station Wire, Beige -Spool  
**300-743** 1000' 4C Solid Station Wire, Beige - Pull Box  
**300-761** 1000' 6C Solid Station Wire, Beige -Spool

### UTP Category-3 Bulk Cable

- 2, 3 or 4-Pair grey category-3 cable
- Unshielded twisted pair (UTP) voice grade communications cable
- Suitable for telephone and security systems
- 24 AWG Solid copper conductors
- Flame retardant type CM
- Suitable for indoor installations
- UL/cUL

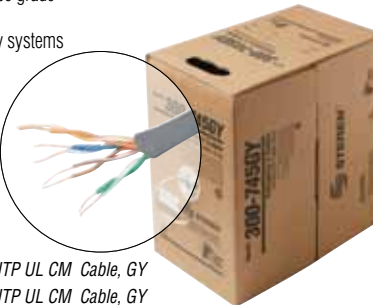

**300-745** 1000' 4pr Cat3 UTP UL CM Cable, GY  
**300-746** 1000' 3pr Cat3 UTP UL CM Cable, GY  
**300-747** 1000' 2pr Cat3 UTP UL CM Cable GY

### UTP Plenum Category-3 Bulk Cable

- 4-Pair grey CMP Category-3 Cable
- Unshielded twisted pair (UTP) voice grade communications cable
- Suitable for telephone and security systems
- 24 AWG Solid copper conductors
- Flame retardant type CMP
- Suitable for indoor installations
- UL/cUL, CSA, ETL Listed

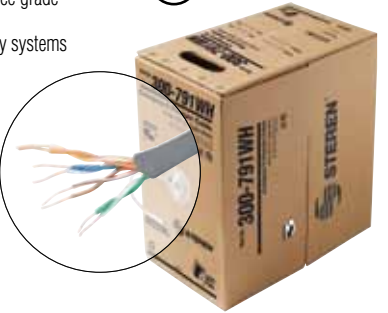

**300-791** 1000' 4pr Cat3 UTP UL CMP Cable, GY, WH

### Signal/Control Cable

- Power-limited applications
- Suitable for Residential and commercial use
- Standard color-coded conductor jackets keep track of cable functions
- Flame retardant PVC jackets
- 22 AWG Stranded copper conductors
- UL or ETL Listed, OSHA acceptable



**300-732** 1000' 2C Stranded Power Limited Cable CL2, WH

### Signal/Control Cable

- Power-limited applications
- Suitable for residential and commercial use
- Standard color-coded conductor jackets keep track of cable functions
- Flame retardant PVC jackets
- 22 AWG Solid copper conductors
- UL or ETL Listed, OSHA acceptable

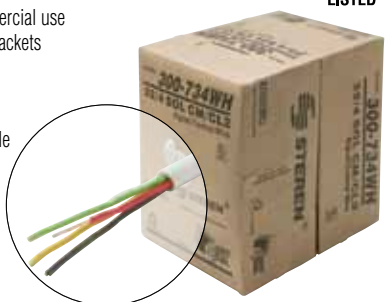

**300-734** 1000' 4C Solid Power Limited Cable CL2, WH



**UTP CM Category-5E Bulk Cable**



- Category-5E unshielded twisted pair (UTP)
- Swept to 350MHz
- 4-Pair – easily identified
- 24 AWG solid annealed bare copper conductors
- Flame retardant – type CM (riser)
- Suitable for indoor installations
- Exceeds EIA/TIA 568, UL, CSA and ISO/IEC 11801 specifications
- UL/cUL



**300-783** 1000' 4pr Cat5e UTP UL CM Cable, BL, GY, OR, RD, WH, YL - Pull Box  
**300-784** 1000' 4pr Cat5e UTP Cable, BL, WH, YL - Reel in Box

**Direct Burial CAT 5e Bulk Cable**



- Direct burial powdered filled Category-5E unshielded twisted Pair (UTP)
- Swept to 350MHz
- 4-Pair – easily identified
- 24 AWG solid annealed bare copper conductors
- Flame retardant – type CM
- Exceeds EIA/TIA 568, UL, CSA and ISO/IEC 11801 specifications



**300-785** 1000' 4pr Cat5e UTP Direct Burial Cable, BK

**UTP CMR Category-5E Bulk Cable**



- Category-5E unshielded twisted pair (UTP)
- Swept to 350MHz
- 4-Pair – easily identified
- 24 AWG solid annealed bare copper conductors
- Flame retardant – type CMR
- Suitable for indoor installations
- Exceeds EIA/TIA 568, UL, CSA and ISO/IEC 11801 specifications
- UL/cUL



**300-781** 1000' 4pr Cat5e UTP UL CMR Cable, BL, WH

**UTP Plenum Category-5E Bulk Cable**



- Category-5E unshielded twisted pair (UTP)
- Swept to 350MHz
- 4-Pair – easily identified
- 24 AWG Solid annealed bare copper conductors
- Flame retardant type CMP (Plenum)
- Suitable for indoor installations
- Exceeds EIA/TIA 568, UL, CSA and ISO/IEC 11801 specifications
- ETL Listed



**300-793** 1000' 4pr Cat5e UTP ETL CMP Cable, BL, GY, WH

**UTP CM Category-6 Bulk Cable**



- Category-6 unshielded twisted pair (UTP)
- Swept to 550MHz
- 4-Pair – easily identified
- 23 AWG Solid annealed bare copper conductors
- Flame retardant – type CM
- Suitable for indoor installations
- Exceeds EIA/TIA 568, UL, CSA and ISO/IEC 11801 specifications
- UL/cUL
- Reel in box



**300-786** 1000' 4pr Cat6 UTP UL CM Cable, BL, GR, GY, WH, YL -Reel in Box

**UTP CMR Category-6 Bulk Cable**



- Category-6 unshielded twisted pair (UTP)
- Swept to 550MHz
- 4-Pair – easily identified
- 23 AWG Solid annealed bare copper conductors
- Flame retardant – type CMR (riser)
- Suitable for indoor installations
- Exceeds EIA/TIA 568, UL, CSA and ISO/IEC 11801 specifications
- UL/cUL
- Reel in box

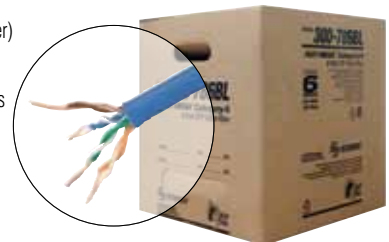

**300-789** 1000' 4pr Cat6 UTP UL CMR Cable, BL, WH - Reel in Box

**UTP Plenum Category-6 Bulk Cable**



- Category-6 unshielded twisted pair (UTP)
- Swept to 550MHz
- 4-Pair – Easily identified
- 23 AWG solid annealed bare copper conductors
- Flame retardant. Type CMP (Plenum)
- Suitable for indoor installations
- Exceeds EIA/TIA 568, UL, CSA and ISO/IEC 11801 specifications
- ETL Listed



**300-796** 1000' 4pr Cat6 UTP UL CMP Cable, BL, GY, WH

**Contact your Steren Representative for more information**

**Phone: (800) 266-3333**



## STRUCTURED WIRE

### Structured Wiring Cable

- Easy-to-install bundle
- Eliminates multiple cable pulls
- Readies premises for future services
- RG59 Coax
- 4-Pair 24 AWG CAT5E UTP cable
- 18/2 Speaker/power limited circuit cable
- Flame retardant PVC jackets
- UL Listed
- NEC type CM
- Supplied in spools



**300-669** 1000' Cat5e+18/2 + RG59 Bundled UL Cable, PR

### Structured Wiring Cable

- Easy-to-install bundle
- Eliminates multiple cable pulls
- Readies premises for future services
- 4-Pair 24 AWG CAT5E UTP cable
- 16/4 Speaker/power limited circuit cable
- Flame retardant PVC jackets
- UL Listed
- NEC type CM
- Supplied in spools

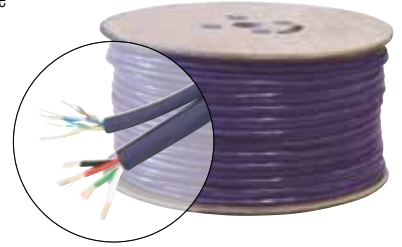

**300-770** 500' CAT5e + 16/4 UL Cable, PR

### Structured Wiring Cable

- Easy-to-install bundle
- Eliminates multiple cable pulls
- Readies premises for future services
- 18 AWG RG6/U-quad coax
- 4-Pair 24 AWG CAT5E UTP cable
- Flame retardant PVC jackets
- UL Listed
- NEC type CM
- Supplied in spools



**300-771** 500' CAT5e + 2-RG6/Quad UL Cable, GY

### Structured Wiring Cable

- Easy-to-install bundle
- Eliminates multiple Cable Pulls
- Readies premises for future services
- 18 AWG RG6/U-quad coax
- 4-Pair 24 AWG CAT5E UTP cable
- Flame retardant PVC jackets
- UL Listed
- NEC type CM
- Supplied in spools

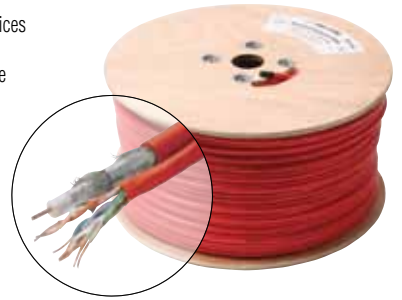

**300-772** 500' Cat 5e + RG6/Quad UL Cable, RD

### Structured Wiring Cable

- Easy-to-install bundle
- Eliminates multiple cable pulls
- Readies premises for future services
- 18 AWG RG6/U-quad coax
- 4-Pair 24 AWG CAT5E UTP cable
- Flame retardant PVC jackets
- UL Listed
- NEC type CM
- Supplied in spools

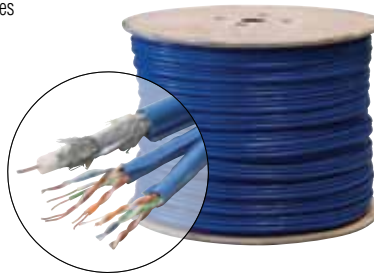

**300-773** 500' 2CAT5e + RG6/Quad UL Cable, BL, WH

### Structured Wiring Cable

- Easy-to-install bundle
- Eliminates multiple cable pulls
- Readies premises for future services
- 18 AWG RG6/U-Quad coax
- 4-Pair 24 AWG CAT5E UTP cable
- Flame retardant PVC jackets
- UL Listed
- NEC type CM
- Supplied in spools

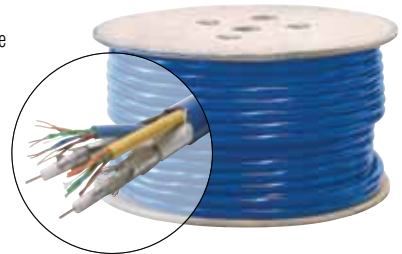

**300-774** 500' 2Cat5e + 2-RG6/Quad Bundled UL Cable, BL

**Contact your  
Steren Representative  
for more information**

**Phone: (800) 266-3333**



**Thermostat Cable**



- Excellent for power-limited applications
- Suitable for residential and commercial use
- Standard color-coded conductor jackets
- Flame retardant PVC jackets
- 20 AWG solid copper conductors
- UL or ETL Listed, OSHA acceptable, NEC Type CL2
- Supplied in 500' spool

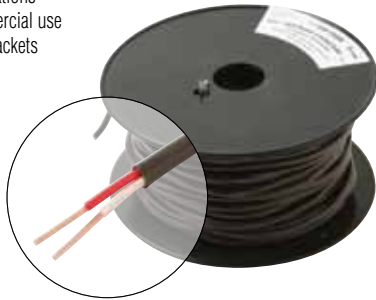

**300-722** 500' 20AWG/2C Solid Power Limited Cable CL2, BR  
**300-724** 500' 20AWG/4C Solid Power Limited Cable CL2, BR

**Thermostat Cable**



- Excellent for power-limited applications
- Suitable for residential and commercial use
- Standard color-coded conductor jackets
- Flame retardant PVC jackets
- 18 AWG Solid copper conductors
- UL or ETL Listed, OSHA acceptable, NEC Type CL2
- Supplied in 500' spool

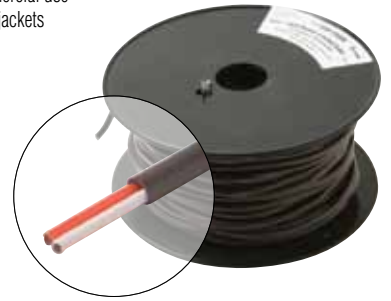

**300-752** 500' 18AWG/2C Thermostat Cable, WH

**Thermostat Cable**



- Excellent for thermostats, HVAC controls, heat pumps, intercom systems, remote control Units, doorbells, alarms, other power-limited applications
- Suitable for residential and commercial use
- Standard color-coded conductor jackets
- Flame retardant PVC jackets
- 18 AWG Solid copper conductors
- UL or ETL Listed, OSHA acceptable, NEC Type CL2
- Supplied in 500' spool



**300-753** 500' 18AWG/3C Thermostat Cable, WH

**Thermostat Cable**



- Excellent for power-limited applications
- Suitable for residential and commercial use
- Standard color-coded conductor jackets
- Flame retardant PVC jackets
- 18 AWG Solid copper conductors
- UL or ETL Listed, OSHA acceptable, NEC Type CL2
- Supplied in 500' spool

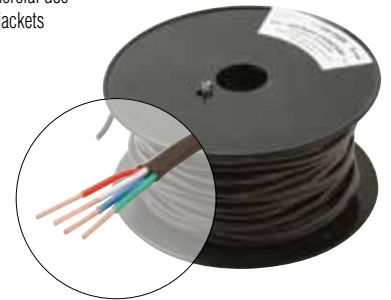

**300-754** 500' 18AWG/4C Thermostat Cable, WH

**Thermostat Cable**



- Excellent for power-limited applications
- Suitable for residential and commercial use
- Standard color-coded conductor jackets
- Flame retardant PVC jackets
- 18 AWG Solid copper conductors
- UL or ETL Listed, OSHA acceptable, NEC Type CL2
- Supplied in 250' spool

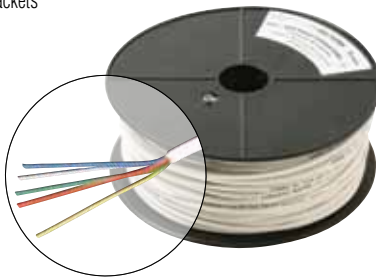

**300-755** 250' 18AWG/5C Thermostat Cable, WH

**Thermostat Cable**



- Excellent for power-limited applications
- Suitable for residential and commercial use
- Standard color-coded conductor jackets
- Flame retardant PVC jackets
- 18 AWG Solid copper conductors
- UL or ETL Listed, OSHA acceptable, NEC Type CL2
- Supplied in 250' spool

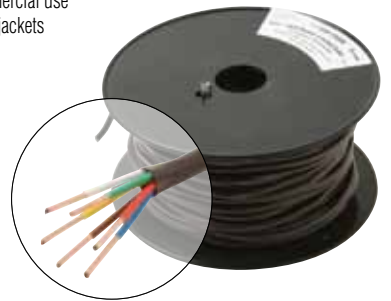

**300-756** 250' 18AWG/6C Thermostat Cable, WH

**Thermostat Cable**



- Excellent for power-limited applications
- Suitable for residential and commercial use
- Standard color-coded conductor jackets
- Flame retardant PVC jackets
- 18 AWG Solid copper conductors
- UL or ETL Listed, OSHA acceptable, NEC Type CL2
- Supplied in 250' spool

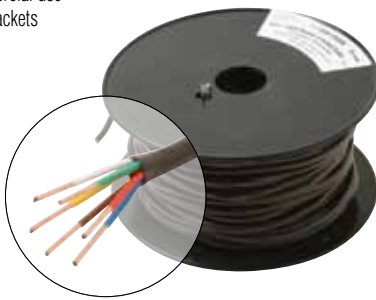

**300-757** 250' 18AWG/7C Thermostat Cable, WH

**Thermostat Cable**



- Excellent for power-limited applications
- Suitable for residential and commercial use
- Standard color-coded conductor jackets
- Flame retardant PVC jackets
- 18 AWG Solid copper conductors
- UL or ETL Listed, OSHA acceptable, NEC Type CL2
- Supplied in 250' spool

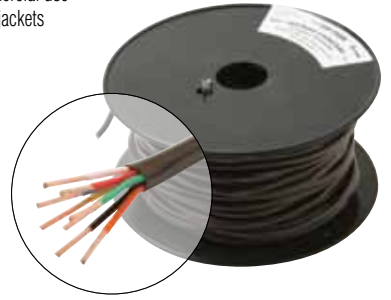

**300-758** 250' 18AWG/8C Thermostat Cable, WH

**Bulk Cable**



## Notes

A large rectangular area enclosed by a dotted line, intended for handwritten notes.



power power **power** power







**AC-DC Converter**

- Universal 110VAC 50-60 Hz AC-DC adapter
- 6' Cord
- LED power indicator
- Double insulation
- Switchable output polarity
- Universal output plugs
- Display packaged for resale



UL US LISTED  
RP

**900-032** 300mA AC/DC Power Supply

**AC-DC Converter**

- Universal 110VAC 50-60 Hz AC-DC adapter
- 6' Cord
- LED power indicator
- Double insulation
- Switchable output polarity
- Universal output plugs
- Display packaged for resale



RP

**900-050** 500mA Universal AC Adapter

**AC-DC Converter**

- Universal 110VAC 50-60 Hz AC-DC adapter
- 6' Cord
- LED power indicator
- Double insulation
- Switchable output polarity
- Universal output plugs
- Display packaged for resale



UL US LISTED  
RP

**900-051** 500mA Universal AC Adapter UL

**AC-DC Converter**

- Universal 110VAC 50-60 Hz AC-DC adapter
- 6' Cord
- LED power indicator
- Double insulation
- Switchable output polarity
- Universal output plugs
- Display packaged for resale



RP

**900-052** 500mA Universal AC Adapter UL

**AC-DC Converter**

- Universal 110VAC 50-60 Hz AC-DC adapter
- 6' Cord
- LED power indicator
- Double insulation
- Switchable output polarity
- Universal output plugs
- Display packaged for resale



UL US LISTED  
RP

**900-100** 1000mA Universal AC Adapter

**AC-DC Converter**

- Universal 110VAC 50-60 Hz AC-DC adapter
- 6' Cord
- LED power indicator
- Double insulation
- Switchable output polarity
- Universal output plugs
- Display packaged for resale



RP

**900-102** 1000mA Universal AC Adapter

**AC-DC Converter**

- Universal 110VAC 50-60 Hz AC-DC adapter
- 6' Cord
- LED power indicator
- Double insulation
- Display packaged for resale



UL US LISTED  
RP

**900-105** 750mA Universal Switching AC Adapter UL

**Digital Equipment AC Adapter**

- Electronic switching power supply
- 6' Cord
- Universal 110VAC 50-60Hz AC-DC adapter with EMI suppression and short-circuit protection
- Switchable output polarity and comes with universal output plugs



UL US LISTED  
RP

**900-110** 1000mA Universal Switching AC Adapter

**Power**

**Equipment AC Power Cord**

- Power cord
- 18 AWG stranded copper wire
- Black jacketed 120VAC 15A 1875W
- UL Listed



**505-370** 6' 3-Wire AC Power Extension Cord UL



**Equipment AC Power Cord**

- Power cord
- 18 AWG stranded copper wire
- Black jacketed 120VAC 15A 1875W
- UL Listed



**505-375** 6' 3-Wire AC Power Replacement Cord UL



**Equipment AC Power Cord**

- Power cord
- 18 AWG stranded copper wire
- Black jacketed 120VAC 15A 1875W
- UL Listed



**505-390** 6' 2-Wire Non-Polarized AC Power Cord UL



**Equipment AC Power Cord**

- Power cord
- 18 AWG stranded copper wire
- Black jacketed 120VAC 15A 1875W
- UL Listed



**505-395** 6' 2-Wire Polarized AC Power Cord UL



**Equipment AC Power Cord**

- Power cord
- 18 AWG stranded copper wire
- Black jacketed 120VAC 15A 1875W
- UL Listed



**505-396** 6' 2-Wire Polarized Dual Insulated AC Power Cord UL



**AC Plug-In Adapter**

- 120VAC 15A 1875W 3-Wire NEMA 5-15 Grounded outlet

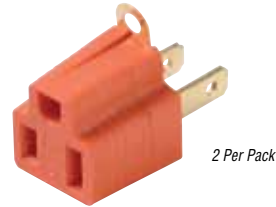

2 Per Pack

**905-100** AC Ground Adapter UL



**Surge-Protected Strip**

- Surge protected multiple outlet strip
- 3-Wire NEMA 5-15 grounded outlets
- 14 AWG 3-Wire heavy-duty grounded 4ft power cord
- Less than 1ns response time
- 125VAC 15A 1875W
- UL Listed
- Display packaged for resale
- 1-MOV protection

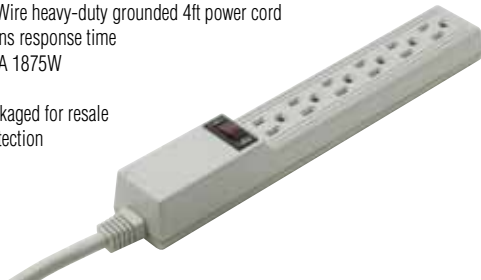

**905-106** 6 Outlet Plastic Surge Strip, 150 Joules UL



**Surge-Protected Strip**

- Surge protected multiple outlet strip
- 3-Wire NEMA 5-15 grounded outlets
- 14 AWG 3-Wire heavy-duty grounded 3ft power cord
- Less than 1ns response time
- 125VAC 15A 1875W
- UL Listed
- Display packaged for resale
- 1-MOV protection



**905-109** 6-Outlet Strip Surge, 90 Joules UL





**Surge-Protected Strip**

- Surge protected multiple outlet strip
- 3-Wire NEMA 5-15 Grounded outlets
- 14 AWG 3-wire heavy-duty grounded 4ft power cord
- Less than 1ns response time
- 125VAC 15A 1875W
- UL Listed
- Display packaged for resale
- 1-MOV protection



**905-206** 6 Outlet Metal Surge Strip, 110 Joules UL

**Home Theater Surge Protector**

- 8 power outlets plus 1 each of coaxial, modem, and telephone connections
- 8ft power cable is the optimum length and gives flexibility in equipment placement
- Reduces electronic noise giving the best possible sound and picture from electrical components
- Provides power protection up to 2160 Joules
- Power switch with circuit breaker to shut off power if overload in excess of 15 Amps
- UL Listed



**BL-905-408** 2160 Joule Surge Protector

**International Voltage Adapter**

- International voltage converter kit
- Use personal care appliances while traveling in foreign countries
- Dual Switchable 50/1600W
- Converts 220-240VAC foreign voltage to 110-120VAC U.S. voltage 50/60Hz
- Kit includes 5 plug adapters to fit outlets in virtually any country
- Custom travel case included



**910-010** International Voltage Converter Kit

**Surge-Protected Strip**

- Surge protected multiple outlet strip
- 3-Wire NEMA 5-15 grounded outlets
- 14 AWG 3-conductor heavy-duty grounded 6ft power cord
- Less than 1ns response time
- 125VAC 15A 1875W
- UL Listed
- Display packaged for resale
- Phone, fax, modem and TV ports
- 6-MOV 3-line protection



**905-222** 9 Outlet Plastic Surge Strip, 1500 Joules UL

**Plug-In Surge Protector**

- Surge protected wall-mounted adapters
- 3-Wire NEMA 5-15 grounded outlets
- High-impact ABS plastic housing
- Brass grounding plug
- 120VAC 15A 1875W
- 3-MOV 3 line protection
- UL Listed



**905-304** 3 Outlet Plug-In Surge Protector, 270 Joules UL

**Plug-In Surge Protector**

- Surge protected wall-mounted adapter
- 3-Wire NEMA 5-15 grounded outlets
- High-impact ABS plastic housing
- Brass grounding plug
- 120VAC 15A 1875W
- 1-MOV protection
- UL Listed



**905-302** 1 Outlet Plug-In Surge Protector, 90 Joules UL

**Plug-In Surge Protector**

- Surge protected wall-mounted adapters
- 3-Wire NEMA 5-15 grounded outlets
- High-impact ABS plastic housing
- Brass grounding plug
- 120VAC 15A 1875W
- 3-MOV 3 line protection
- Phone, fax, modem ports
- UL Listed



**905-308** 6 Outlet Telephone Plug-In Surge Protector, 420 Joules UL

**Plug-In Surge Protector**

- Surge protected wall-mounted adapters
- 3-Wire NEMA 5-15 grounded outlets
- High-impact ABS plastic housing
- Brass grounding plug
- 120VAC 15A 1875W
- 3-MOV 3 line protection
- UL Listed



**905-307** 6 Outlet Plug-In Surge Protector, 370 Joules UL

**Plug-In Surge Protector**

- Surge protected wall-mounted adapters
- 3-Wire NEMA 5-15 grounded outlets
- High-impact ABS plastic housing
- Brass grounding plug
- 120VAC 15A 1875W
- 3-MOV 3 line protection
- UL Listed



905-310

905-315

- 905-310** 1 Outlet Telephone Plug-In Surge Protector, 210 Joules UL
- 905-315** 1 Outlet CATV-Satellite Plug-In Surge Protector, 210 Joules UL

**Pushbutton Switch**

- 1A-125VAC miniature momentary switch
- SPST normally open
- Solder terminals
- Brass-silver contact



- 450-010BK** Mini-Pushbutton Black SPST N/O
- 450-010RD** Mini-Pushbutton Red SPST N/O

**Car-Lighter Adapter**

- 6" Cigarette lighter Y-cord



- 255-283** 6" Cigarette Lighter Y Cable

**Miniature Toggle Switch**

- 5A-125VAC bat-handle toggle switch
- Solder terminals
- Brass-silver contact



- 450-250** Mini-Toggle SPDT ON-ON

**Submini Toggle Switch**

- 3A-125VAC bat-handle toggle switch
- Solder terminals
- Brass-silver contact



- 450-210** Submini-Toggle SPDT ON-ON

**Miniature Toggle Switch**

- 5A-125VAC bat-handle toggle switch
- Solder terminals
- Brass-silver contact



- 450-260** Mini-Toggle DPDT ON-ON

**Contact your Steren Representative for more information**

**Phone: (800) 266-3333**



**Retail  
Ready  
Solutions**



Contact us Toll Free: **800-266-3333**



*Fulfillment Solutions • Packaged Products • Custom Assemblies • Drop Hardware*

**We're the Jumper Shop.  
Making Quality Connections.**



Contact us Toll Free: **800-266-3333**



# Charge Card Application

Steren Electronics International, LLC.  
 6260 Sequence Drive, Suite 110  
 San Diego, California 92121  
 Tel (800) 266-3333  
 FAX (800) 266-3334

## Important Information

We accept VISA, MASTERCARD, DISCOVER and AMERICAN EXPRESS.

## General Information

Company Name		Password
Street Address		
Other Authorized Mailing Address		
City	State	Zip
Telephone	FAX	

## Business Profile

Primary Charge Account Number		Exp Date
Issuing Bank	Card Type	Card Validation Code
Full Name on Card		
Billing Statement Street Address		
City	State	Zip

Secondary Charge Account Number		Exp Date
Issuing Bank	Card Type	Card Validation Code
Full Name on Card		
Billing Statement Street Address		
City	State	Zip

## Authorization

I authorize the user of the above credit card(s)

(Authorized Signature)	Date
(Authorized Signature)	Date

The undersigned cardholder hereby authorizes Steren Group of Companies to charge to the card account (through signature on file) as indicated on this form, any transactions while the account is in effect. It is also noted either party may cancel this agreement upon written notification to the other party. When calling in, you will be asked for your password as a secondary security precaution. Any other person authorized to charge against your credit card must provide your password to confirm authorization.



## Credit Application

Mail to: Steren Electronics International, LLC.  
 Attention: New Accounts  
 6260 Sequence Drive, Suite 110  
 San Diego, California 92121  
 Tel (800) 266-3333  
 FAX (800) 266-3334

### Important Information

This information is for the exclusive use of our Credit Department and will be held in the strictest of confidence.

Your current year-end financial statement (balance sheet and income statement) must accompany this application if the credit line desired exceeds \$5000. Unaudited financial statements must be signed and dated by the respective owner or officer. Please indicate what period is covered by each statement.

California customers exempt from sales tax must submit a signed resale certificate.

### General Information

Business Legal Name		
Business Trade Name (dba) or Previous Name		Tax I.D. No.
Street Address (required)	P.O. Box	
City	State	Zip
Telephone	FAX	

### Business Profile

Description of Primary Business		
Number of Employees		
Credit Line Desired	Annual Sales Volume	
Legal Structure of the Business	<input type="checkbox"/> Proprietorship	<input type="checkbox"/> Partnership <input type="checkbox"/> Corporation
State in which chartered	Year Business Established	
Length of time at the above address	<input type="checkbox"/> Own	<input type="checkbox"/> Lease
Number of branches/outlets	Square Footage	
Have you ever filed for bankruptcy ?	<input type="checkbox"/> No	<input type="checkbox"/> Personal <input type="checkbox"/> Business
Date Filed	Current Status	
Corporate Officers or Principal Owners		
Name	Title	Telephone
Name	Title	Telephone
Name	Title	Telephone

### Personal Credit Information

Authorization to Run Credit  Yes

By Checking Yes you are giving Steren Electronics International LLC. permission to check your credit report. You MUST check the box before we can process your application.

Name	Name
Home Street Address	Home Street Address
City/State/Zip	City/State/Zip
Telephone	Telephone
Social Security No.	Social Security No.
Driver Licence No.	Driver Licence No.

Please complete both sides

## Bank Information

Bank Name

Street Address

P.O. Box

City

State

Zip

Account Officer

Telephone

FAX

Checking Account No.

Loan Account No.

Bank Name

Street Address

P.O. Box

City

State

Zip

Account Officer

Telephone

FAX

Checking Account No.

Loan Account No.

## Primary Trade References

*(Related Industry, Purchases During Last 12 Months)*

Name

Telephone

FAX

Address

City

State

Zip

Contact

Account No.

Name

Telephone

FAX

Address

City

State

Zip

Contact

Account No.

Name

Telephone

FAX

Address

City

State

Zip

Contact

Account No.

## Credit Agreement

*This credit application and agreement is submitted to Steren Electronics International, LLC. (hereafter referred to as Steren), to obtain trade credit. Customer agrees to make payment in full to Steren for all amounts due according to Steren's invoices. Customer agrees to pay Steren, as interest, an amount equal to 11/2% per month, or the maximum provided by law (whichever is less) for invoice amounts that are past due. A \$15.00 charge will be assessed for any returned checks. Should customer default in such payment(s), Steren shall have the right, without notice to Customer, to declare all invoice amounts due and payable. In the event that Steren should commence any action or actions, or otherwise seek to enforce this agreement against Customer, Customer agrees to pay reasonable attorney(s) fees, court costs and other expenses incurred by Steren, whether or not suit is filed. This agreement is strictly confidential and is not transferable or assignable without the prior consent of Steren. Customer agrees that any change in liability from any debts incurred to Steren due to a change in Customer's form of business, shall not be effective as to Steren, until Steren receives actual notice of the change by certified mail. This agreement is entered into in, and shall be governed by and construed in accordance with the laws of the State of California. By execution hereof, Customer agrees to be subject to the jurisdiction of the courts of the State of California.*

## Authorization

*By signing this agreement, I/we authorize the release of credit and banking information, to Steren Electronics International, LLC. by the references listed above for the purpose of establishing credit.*

Company Name

Signed at

Date

Officer/Owner/Partner

(Authorized Signature)

Name and Title

Signed at

Date

Officer/Owner/Partner

(Authorized Signature)

Name and Title





# Order Form

Steren Electronics International, LLC.  
 6260 Sequence Drive, Suite 110  
 San Diego, California 92121-4358  
 Tel (800) 266-3333 (888) 267-7771 (858) 546-5000  
 FAX (800) 266-3334  
 e-mail sales@steren.com <http://www.sterenusa.com>

Bill To: \_\_\_\_\_

Address \_\_\_\_\_

City \_\_\_\_\_ State \_\_\_\_\_ Zip \_\_\_\_\_

Ship To: \_\_\_\_\_

Address \_\_\_\_\_

City \_\_\_\_\_ State \_\_\_\_\_ Zip \_\_\_\_\_

Date: \_\_\_\_\_

Purchase Order No. \_\_\_\_\_

Salesperson: \_\_\_\_\_

Date: \_\_\_\_\_

Purchase Order No. \_\_\_\_\_

Salesperson: \_\_\_\_\_



Item	Quantity	Description	Unit Price	Extension
1				
2				
3				
4				
5				
6				
7				
8				
9				
10				
11				
12				
13				
14				
15				
<b>Total</b>				

Authorized Signature: \_\_\_\_\_



## Order Form

*Steren Electronics International, LLC.*  
 6260 Sequence Drive, Suite 110  
 San Diego, California 92121-4358  
 Tel (800) 266-3333 (888) 267-7771 (858) 546-5000  
 FAX (800) 266-3334  
 e-mail [sales@steren.com](mailto:sales@steren.com) <http://www.sterenusa.com>

Item	Quantity	Description	Unit Price	Extension
16				
17				
18				
19				
20				
21				
22				
23				
24				
25				
26				
27				
28				
29				
30				
31				
32				
33				
34				
35				
36				
37				
38				
39				
40				
41				
42				
43				
<b>Total</b>				

200-015 .....	7	200-133 .....	13	200-268 .....	67	201-103 .....	29
200-017 .....	7	200-134 .....	9	200-268-10 .....	67	201-104 .....	29
200-017-25 .....	7	200-135 .....	9	200-271 .....	31	201-106 .....	29
200-022 .....	8	200-138 .....	9	200-272 .....	31	201-108 .....	29
200-025 .....	7	200-139 .....	9	200-273 .....	31	201-201 .....	26
200-027 .....	8	200-139-10 .....	9	200-274 .....	31	201-202 .....	26
200-027-25 .....	8	200-141 .....	9	200-278 .....	31	201-203 .....	26
200-029 .....	7	200-141-10 .....	9	200-279 .....	31	201-204 .....	26
200-029-25 .....	7	200-142 .....	9	200-280 .....	31	201-221 .....	27
200-030 .....	8	200-142-10 .....	9	200-283 .....	31	201-222 .....	27
200-030-25 .....	8	200-143 .....	9	200-286 .....	31	201-223 .....	27
200-031 .....	8	200-144 .....	9	200-288 .....	31	201-224 .....	27
200-033 .....	8	200-145 .....	9	200-290 .....	32	201-232 .....	30
200-033-25 .....	8	200-147 .....	9	200-292 .....	32	201-234 .....	30
200-034 .....	8	200-148 .....	10	200-297 .....	32	201-242 .....	30
200-034-25 .....	8	200-150 .....	14	200-310 .....	37	201-244 .....	30
200-035 .....	8	200-155 .....	14	200-315 .....	37	201-252 .....	30
200-035-25 .....	8	200-155-10 .....	14	200-411 .....	67	201-254 .....	30
200-036 .....	8	200-158 .....	14	200-418 .....	68	201-261 .....	28
200-036-25 .....	8	200-160 .....	13	200-490 .....	35	201-262 .....	28
200-037 .....	9	200-160-10 .....	13	200-500 .....	35	201-264 .....	28
200-037-25 .....	9	200-165 .....	13	200-510 .....	35	201-266 .....	28
200-038 .....	9	200-170 .....	16	200-720 .....	10	201-268 .....	28
200-038-25 .....	9	200-170-10 .....	16	200-731 .....	10	201-272 .....	28
200-039 .....	8	200-173 .....	14	200-734 .....	17	201-273 .....	28
200-039-25 .....	8	200-173-10 .....	14	200-748 .....	18	201-274 .....	28
200-040 .....	8	200-175 .....	14	200-750 .....	18	201-276 .....	29
200-040-25 .....	8	200-177 .....	14	200-844 .....	11	201-278 .....	29
200-041 .....	8	200-178 .....	14	200-866 .....	18	201-281 .....	27
200-041-25 .....	8	200-190 .....	10	200-870 .....	18	201-282 .....	27
200-043 .....	8	200-192 .....	10	200-872 .....	18	201-283 .....	27
200-043-25 .....	8	200-193 .....	10	200-874 .....	18	201-284 .....	27
200-045 .....	13	200-194 .....	17	200-882 .....	18	201-403 .....	30
200-045-25 .....	13	200-195 .....	17	200-886 .....	18	201-406 .....	30
200-050 .....	11	200-196 .....	16	200-904 .....	38	201-408 .....	30
200-050-25 .....	11	200-197 .....	17	200-905 .....	38	201-410 .....	30
200-051 .....	11	200-198 .....	17	200-910 .....	101	201-412 .....	30
200-051-25 .....	11	200-199 .....	17	200-915 .....	101	201-416 .....	30
200-053 .....	11	200-202 .....	25	200-925 .....	101	201-420 .....	30
200-053-25 .....	11	200-203 .....	25	200-927 .....	101	203-101 .....	37
200-055 .....	12	200-204 .....	25	200-929 .....	101	203-250 .....	37
200-056 .....	11	200-206 .....	25	200-931 .....	101	203-270 .....	37
200-057 .....	12	200-208 .....	25	200-932 .....	101	203-510 .....	94
200-057-25 .....	12	200-212 .....	25	200-933 .....	101	203-550 .....	95
200-058 .....	12	200-213 .....	25	200-936 .....	101	203-560 .....	95
200-058-25 .....	12	200-214 .....	25	200-937 .....	101	203-606 .....	97
200-059 .....	12	200-222 .....	26	200-939 .....	102	203-620 .....	94
200-060 .....	10	200-223 .....	26	200-951 .....	33	203-621 .....	94
200-063 .....	10	200-224 .....	26	200-952 .....	33	203-622 .....	94
200-063-10 .....	10	200-230 .....	32	200-953 .....	33	203-630 .....	94
200-075 .....	12	200-232 .....	32	200-954 .....	33	203-635 .....	94
200-075-25 .....	12	200-234 .....	32	200-955 .....	33	203-640 .....	94
200-100 .....	12	200-236 .....	32	200-959 .....	35	203-650 .....	95
200-100-25 .....	12	200-246 .....	32	200-960 .....	34	203-661 .....	94
200-103 .....	13	200-248 .....	32	200-961 .....	33	204-001 .....	89
200-103-25 .....	13	200-251 .....	67	200-962 .....	34	204-004 .....	89
200-104 .....	13	200-251-10 .....	67	200-963 .....	34	204-005 .....	89
200-104-25 .....	13	200-252 .....	67	200-964 .....	34	204-007 .....	89
200-106 .....	12	200-252-10 .....	67	200-965 .....	34	204-009 .....	89
200-106-10 .....	12	200-253 .....	68	200-966 .....	35	204-011 .....	89
200-107 .....	12	200-253-10 .....	68	200-968 .....	35	204-031 .....	89
200-107-25 .....	12	200-254 .....	67	200-969 .....	34	204-034 .....	89
200-108 .....	13	200-255 .....	68	200-972 .....	35	204-036 .....	89
200-108-25 .....	13	200-255-10 .....	68	200-975 .....	36	204-200 .....	90
200-110 .....	15	200-256 .....	67	200-976 .....	35	204-202 .....	90
200-110-25 .....	15	200-258-10 .....	67	200-977 .....	36	204-205 .....	90
200-117 .....	16	200-258AL .....	67	200-984 .....	36	204-300 .....	90
200-122 .....	9	200-260 .....	68	200-985 .....	36	204-350 .....	90
200-122-10 .....	9	200-260-10 .....	68	200-986 .....	36	204-400 .....	90
200-123 .....	9	200-261 .....	68	200-986-10 .....	36	204-407 .....	97
200-123-10 .....	9	200-263 .....	68	200-988 .....	36	204-451 .....	96
200-130 .....	14	200-265 .....	68	200-988-10 .....	36	204-452 .....	96
200-130-10 .....	14	200-266 .....	68	200-992 .....	94	204-453 .....	96
200-131 .....	9	200-266-10 .....	68	200-993 .....	94	204-454 .....	96
200-131-10 .....	9	200-267 .....	67	201-101 .....	29	205-000 .....	45
200-132 .....	14	200-267-10 .....	67	201-102 .....	29	205-010 .....	45

# Product Index

205-015	45	206-295	47	251-200	22	254-135BL	47
205-018	45	206-297	47	251-310	23	254-140BL	47
205-020	45	208-420	46	251-320	24	254-206	41
205-030	45	208-430	46	251-330	24	254-207	41
205-035	45	208-435	46	251-340	24	254-210BL	44
205-045	45	208-440	46	251-410	17	254-215BL	44
205-090WH	52	208-445	46	251-410-10	17	254-220BL	44
205-110BK	45	208-450	46	251-503	13	254-225BL	44
205-115BK	45	220-100	33	251-503-10	13	254-230BL	44
205-120BK	45	220-120	33	251-505	16	254-235BL	44
205-210BK	45	220-215	33	251-505-10	16	254-240BL	44
205-215BK	45	220-220	33	251-506	16	254-310BL	47
205-220BK	45	220-225	33	251-506-10	16	254-315BL	47
205-230BK	45	220-500	33	251-507	16	254-320BL	47
205-233BK	45	221-110	39	251-507-10	16	254-325BL	47
205-310	45	221-120	38	251-508	16	254-330BL	47
205-315	45	221-352	38	251-508-10	16	254-335BL	47
205-410	46	221-353	38	251-509	22	254-340BL	47
205-415	46	221-355	38	251-509-10	22	254-406IV	48
205-418	46	221-360	38	251-510	22	254-412IV	48
205-420	46	221-365	38	251-510-10	22	254-425IV	48
205-423	46	221-410	36	252-001	39	254-500IV	48
205-430	46	250-105	20	252-002	39	254-503IV	48
205-435	46	250-110	20	252-006	39	254-506IV	48
205-440	46	250-115	20	252-051	39	254-512IV	48
205-445	46	250-135	20	252-052	39	254-525IV	48
205-450	46	250-150	20	252-056	39	254-550IV	48
205-521	45	250-180	21	252-062	39	254-575IV	48
205-523BK	50	250-187	24	252-601	42	254-600IV	48
205-525	45	250-201	24	252-603	42	254-603IV	48
205-527BK	50	250-202	24	252-606	42	254-606IV	48
205-528BK	50	250-220	11	252-612	42	254-612IV	48
205-529	45	250-235	11	252-651	42	254-625IV	48
205-530BK	50	250-236	11	252-653	42	254-650IV	48
205-537	45	250-238	11	252-656	42	254-675IV	48
205-540BK	50	250-535	20	252-662	42	254-706IV	48
205-547	45	250-540	21	252-682	42	254-712IV	48
205-550BK	50	250-613	21	252-684	42	254-725IV	48
205-570BK	50	250-615	21	253-003BL	47	255-010	39
205-580	46	250-700	21	253-006BL	47	255-010RD	39
205-582	46	250-705	21	253-012BL	47	255-010WH	39
205-586	46	250-710	21	253-103IV	48	255-020	39
205-590	46	250-720	21	253-106IV	48	255-025	39
205-592	46	251-002	22	253-112IV	48	255-036	39
205-596	46	251-002-10	22	253-200BK	49	255-037	40
205-603	50	251-004	22	253-203BK	49	255-038	40
205-606	50	251-004-10	22	253-206BK	49	255-039	40
205-612	50	251-110	15	253-212BK	49	255-042	40
205-700	50	251-111	15	253-225BK	49	255-045	40
205-703	50	251-111-10	15	253-250BK	49	255-047	40
205-706	50	251-113	15	253-300BK	49	255-048	40
205-712	50	251-113-10	15	253-303BK	49	255-059	40
205-720	50	251-115	14	253-306BK	49	255-105	41
205-750	50	251-115-10	14	253-310BK	49	255-110	41
205-910	46	251-116	15	253-315BK	49	255-115	41
205-915	46	251-116-10	15	253-325BK	49	255-117	41
205-920	46	251-117	15	253-350BK	49	255-120	41
205-930	46	251-117-10	15	253-375BK	49	255-121	41
205-940	46	251-118	22	253-506IV	48	255-125	41
205-945	46	251-118-10	22	253-512IV	48	255-126	41
205-950	46	251-120	22	253-525IV	48	255-130	41
206-000	45	251-122	22	253-550IV	48	255-131	41
206-010	45	251-130	23	253-606IV	48	255-134	41
206-015	45	251-130-10	23	253-612IV	48	255-135	41
206-200	45	251-134	23	253-625IV	48	255-136	41
206-250	47	251-150	23	253-806IV	49	255-138	41
206-252	47	251-151	16	253-812IV	49	255-140	41
206-273	47	251-152	17	253-825IV	49	255-145	41
206-275	47	251-152-10	17	254-006OR	44	255-150	41
206-276	47	251-153	15	254-012OR	44	255-155	42
206-277	47	251-153-10	15	254-045	40	255-160	42
206-278	47	251-154	15	254-110BL	47	255-165	42
206-282	47	251-155	23	254-115BL	47	255-170	42
206-284	47	251-156	23	254-120BL	47	255-175	42
206-288	47	251-160	23	254-125BL	47	255-185	43
206-289	47	251-165	23	254-130BL	47	255-187	43

255-190	43	300-024	55	300-657	92	302-012	61
255-195	43	300-024-10	55	300-669	106	302-015	61
255-199	47	300-026	55	300-670	92	302-025	61
255-200	47	300-028	55	300-672	92	304-003	61
255-202	47	300-034	55	300-675	92	304-007	61
255-206	47	300-034-10	55	300-677	92	304-015	61
255-208	47	300-036	55	300-685	92	304-025	61
255-209	47	300-037	55	300-722	107	304-050	61
255-211	47	300-039	55	300-724	107	304-100	61
255-217	43	300-054	73	300-732	104	304-707	61
255-219	43	300-062	56	300-734	104	304-715	61
255-220	42	300-064	56	300-741	104	304-725	61
255-225	42	300-066	56	300-743	104	306-007	61
255-230	42	300-067	56	300-745	104	306-015	61
255-235	42	300-068	56	300-746	104	306-025	61
255-240	42	300-070	58	300-747	104	306-707	61
255-255	43	300-072	58	300-752	107	306-715	61
255-258	43	300-072-25	58	300-753	107	308-503	62
255-262	43	300-073	58	300-754	107	308-505	62
255-264	43	300-074	55	300-755	107	308-507	62
255-265	43	300-075	58	300-756	107	308-510	62
255-268	43	300-077	58	300-757	107	308-514	62
255-269	43	300-080	58	300-758	107	308-525	62
255-272	43	300-090	73	300-761	104	308-550	62
255-274	43	300-094	73	300-770	106	308-575	62
255-283	114	300-094-10	73	300-771	106	308-600	62
255-290	43	300-095	73	300-772	106	308-603	62
255-295	44	300-100	95	300-773	106	308-605	62
255-298	44	300-103-10	74	300-774	106	308-607	62
255-314	102	300-124	55	300-781	105	308-610	62
255-315	103	300-130	58	300-783	105	308-614	62
255-316	102	300-142	56	300-784	105	308-625	62
255-317	103	300-145	74	300-785	105	308-650	62
255-318	103	300-146	74	300-786	105	308-675	62
255-319	103	300-147	74	300-789	105	308-707	61
255-320	103	300-149	74	300-791	104	308-900	62
255-322	103	300-164	56	300-793	105	308-903	62
255-410	102	300-166	56	300-796	105	308-905	62
255-412	102	300-168	57	300-840	104	308-907	62
255-413	102	300-168-25	57	300-860	104	308-910	62
255-414	102	300-170	57	300-880	104	308-914	62
255-416	102	300-203	72	300-955	34	308-925	62
255-418	103	300-204	71	301-004	71	308-950	62
255-510	102	300-204-10	71	301-014	71	308-975	62
255-512	102	300-206	71	301-016	71	310-039	56
255-513	102	300-206-10	71	301-024	74	310-040	57
255-514	102	300-213	72	301-064	56	310-042	80
255-516	102	300-214	71	301-064-25	56	310-042-10	80
255-518	103	300-214-10	71	301-066	56	310-043	80
255-712	102	300-215	71	301-068	56	310-100	73
255-714	102	300-216	71	301-094	74	310-103	73
255-716	103	300-216-10	71	301-146	74	310-106	77
255-718	103	300-233	73	301-151	80	310-106-10	77
255-816	103	300-234	72	301-151-10	80	310-108	77
255-932	102	300-234-10	72	301-152	80	310-108-10	77
255-934	102	300-235	72	301-152-10	80	310-110	77
255-936	102	300-235-10	72	301-153	80	310-110-10	77
256-210	104	300-237	72	301-172	57	310-120	77
256-220	104	300-237-10	72	301-172-25	57	310-120-10	77
257-606	48	300-238	72	301-176	57	310-140	78
257-612	48	300-238-10	72	301-178	57	310-140-10	78
258-101	95	300-243	71	301-178-25	57	310-150	78
258-103	95	300-243-10	71	301-182	57	310-161	80
258-661	95	300-251	58	301-188	57	310-161-10	80
258-810	95	300-261	56	301-191	57	310-162	80
259-101	96	300-324	55	301-191-25	57	310-162-10	80
259-103	96	300-324-10	55	301-204	71	310-201	74
260-003	44	300-504	91	301-204-10	71	310-201-10	74
260-006	44	300-508	91	301-214	72	310-202	74
260-012	44	300-552	91	301-214-10	72	310-202-10	74
260-203	44	300-555	91	301-234	72	310-203	75
260-206	44	300-558	91	301-234-10	72	310-203-10	75
260-212	44	300-568	91	301-324	56	310-204	75
260-306OR	44	300-574	91	301-840	104	310-204-10	75
260-700	24	300-650	92	301-880	104	310-206	75
300-003	74	300-653	92	302-007	61	310-206-10	75

# Product Index

310-216	81	400-708	34	506-456	63	528-001	19
310-224	82	400-715	34	506-460	63	528-002	19
310-320	81	400-804	34	506-465	63	528-004	19
310-324	81	400-806	34	506-513	63	528-005	19
310-334	81	400-808	34	506-516	63	528-006	20
310-348	81	400-812	34	506-530	64	550-001	85
310-349	81	400-815	34	506-532	64	550-010	85
310-356	81	400-828	34	506-534	64	550-020	85
310-358	81	400-832	34	506-606	64	550-030	85
310-366	82	400-835	34	506-706	64	550-040	85
310-367	82	400-841	34	506-806	64	550-060	85
310-368	82	400-858	35	506-906	49	550-070	85
310-372	82	400-904	36	506-910	49	550-100	86
310-390	82	400-905	36	506-912	49	550-105	86
310-392	82	450-010BK	114	506-956	49	550-200	86
310-394	82	450-010RD	114	506-960	49	550-205	86
310-399	82	450-210	114	506-962	49	550-210	86
310-410	78	450-250	114	514-013	90	601-500	93
310-415	78	450-260	114	516-005	19	602-010	93
310-415-10	78	500-009	59	516-006	19	602-040	93
310-417	78	500-010	59	516-007	19	602-070	93
310-420	78	500-015	59	516-008	19	602-115	93
310-420-10	78	500-020	59	516-011	37	602-270	93
310-450	78	500-025	59	516-021	37	602-805	93
310-451	78	500-027	59	516-024	37	602-810	93
310-452	79	500-055	59	516-101	69	900-032	111
310-461	79	500-109	59	516-102	69	900-050	111
310-461-10	79	500-110	59	516-108	69	900-051	111
310-463	79	500-115	59	516-111	69	900-052	111
310-463-10	79	500-120	59	516-113	69	900-100	111
310-464	79	500-122	59	516-115	69	900-102	111
310-464-10	79	500-125	59	516-117	69	900-105	111
310-465	79	500-127	59	516-403BK	50	900-110	111
310-465-10	79	500-155	59	516-406BK	50	905-100	112
310-466	79	500-200	92	516-410BK	50	905-106	112
310-467	79	500-210	92	516-423BK	50	905-109	112
310-467-10	79	500-331	60	516-426BK	50	905-206	113
310-468	79	500-336	60	516-430BK	50	905-222	113
310-468-10	79	500-409	59	516-503BK	50	905-302	113
310-485	80	500-411	59	516-506BK	50	905-304	113
310-601	82	500-415	59	516-510BK	50	905-307	113
310-602	82	500-425	59	516-512BK	50	905-308	113
310-801	75	500-427	59	516-515BK	50	905-310	114
310-801-10	75	500-450	59	516-603BK	50	905-315	114
310-802	75	500-453	59	516-606BK	50	910-010	113
310-802-10	75	500-455	59	516-610BK	50	993-610	97
310-803	76	504-207	60	516-612BK	50	993-620	97
310-803-10	76	504-209	60	516-706BK	49	993-640	97
310-804	76	504-217	60	516-710BK	49	993-650	97
310-820	75	504-219	60	516-715BK	49	993-750	97
310-822	75	504-307	60	516-903BK	49	AP-BNC-59	7
310-830	75	504-309	60	516-906BK	49	AP-BNC-6	7
310-851	76	504-319	60	516-910BK	49	AP-RCA-6	7
310-852	76	505-370	112	516-912BK	49	BL-526-030	51
310-853	76	505-375	112	516-915BK	49	BL-526-033	51
310-854	76	505-390	112	516-930BK	49	BL-526-035	51
310-860	76	505-395	112	517-303BK	49	BL-526-037	51
310-871	76	505-396	112	517-306BK	49	BL-526-039	51
310-872	77	506-070	64	517-310BK	49	BL-526-041	51
310-874	77	506-074	64	517-312BK	49	BL-526-051	51
310-876	77	506-113	63	517-315BK	49	BL-905-408	113
310-878	77	506-116	63	517-330BK	49	CL-207-508	52
314-007	61	506-133	63	517-350BK	49	CPS-6STG-P	7
314-015	61	506-136	63	526-101	70	PCT-DRS-59	7
314-025	61	506-153	63	526-102	70		
400-110	97	506-156	63	526-111	70		
400-140	98	506-306	63	526-115	70		
400-150	98	506-310	63	526-117	70		
400-155	98	506-315	63	526-119	71		
400-168	98	506-356	63	526-203BK	50		
400-170	98	506-360	63	526-206BK	50		
400-180	98	506-365	63	526-210BK	50		
400-510	34	506-403	63	526-212BK	50		
400-515	34	506-406	63	526-215BK	50		
400-525	34	506-415	63	526-230BK	50		
400-530	34	506-453	63	526-250BK	50		



**USA Corporate Headquarters**

STEREN ELECTRONICS INTERNATIONAL  
6260 Sequence Drive, Suite 110  
San Diego, California 92121  
**Toll Free 800-266-3333 Fax 800-266-3334**  
**[www.sterenusa.com](http://www.sterenusa.com)**

**East Coast Distribution**

465 East Raines Road,  
Suite 1  
Memphis, Tennessee 38115  
**Tel 901-362-6670 Fax 901-362-6671**

**México Corporate Headquarters**

ELECTRONICA STEREN S.A. DE C.V.  
Calz. Camarones No. 112 (esq. eje 2 norte)  
Col. Obrero Popular, 02840 México, D.F.  
**Toll Free 55-5354-2200 con 60 líneas**  
**[www.steren.com.mx](http://www.steren.com.mx)**



**United States**

**Corporate Headquarters**

6260 Sequence Drive, Ste. 110

San Diego, CA 92121

Toll Free 800-266-3333

Phone 858-546-5000

Fax 858-546-5001

[sales@steren.com](mailto:sales@steren.com)

Please visit us @  
[www.sterenusa.com](http://www.sterenusa.com)