

# Residential and light commercial distribution products



**EATON**

*Powering Business Worldwide*



## Contents

Description	Page
Type CPM/CPL plug-in loadcentres . . . . .	5
Combination (main circuit breaker) single-phase Type 1 . . . . .	6
Combination (main circuit breaker) single-phase Type 3R . . . . .	7
Combination (main circuit breaker) three-phase Type 1 . . . . .	8
Combination (main circuit breaker) three-phase Type 3R . . . . .	9
Type CPL plug-in loadcentres . . . . .	5
Non-combination (main lug only) three-phase Type 1 . . . . .	10
Non-combination (main lug only) single-phase Type 3R . . . . .	11
Non-combination (main lug only) three-phase Type 1 . . . . .	12
Non-combination (main lug only) three-phase Type 3R . . . . .	13
Non-combination (main lug only) 70 A single-phase . . . . .	14
Type CPM/CPL plug-in loadcentre Accessories . . . . .	15
Plug-in circuit breakers for CPM/CPL . . . . .	16
Type BR, DNPL, GFTCB, GFEP and GFXB . . . . .	16
Type BR single- and multi-pole . . . . .	17
Type DNPL Duplex, Independent Quadplex and circuit breaker packs . . . . .	18
Type BR arc fault circuit interrupter . . . . .	19
Types GFCB and GFEP ground fault . . . . .	20
Types GFCB ground fault and Type BR internationally rated . . . . .	21
Types GFXB internationally rated ground fault and Type BR moulded case switches . . . . .	22
Plug-in loadcentre main circuit breakers for CPM/CPL . . . . .	23
Types CSR and CC . . . . .	23
Plug-in circuit breaker accessories for CPM/CPL loadcentres . . . . .	24
Plug-in OEM loadcentre interior assemblies . . . . .	25
Type CH plug-in loadcentres . . . . .	29
Combination and non-combination single-phase . . . . .	30
Plug-in circuit breakers for CH . . . . .	31
Type CH single-, multi-pole and twin . . . . .	31
Type CHP commercial . . . . .	32
Type CHP arc fault circuit interrupter . . . . .	33
Type CHP ground fault . . . . .	34
Plug-in loadcentre main circuit breakers for CH . . . . .	35
Type CSR . . . . .	35
Plug-in loadcentres and circuit breaker accessories for CH . . . . .	36
Type CH accessories . . . . .	36

**Contents (continued)**

<b>Description</b>	<b>Page</b>
Type CBM bolt-on loadcentres . . . . .	37
Combination (main circuit breakers) single- and three-phase aluminum bus . . . . .	37
Combination (main circuit breakers) single- and three-phase copper bus . . . . .	38
Non-combination (main lug only) single- and three-phase aluminum bus . . . . .	39
Non-combination (main lug only) single- and three-phase copper bus . . . . .	40
Bolt-on circuit breakers for CMB/CBL . . . . .	41
Type BAB and QBHW single- and multi-pole . . . . .	41
Type QBA arc fault circuit interrupter and DNBA duplex . . . . .	42
Type QBGF and QBGFEP ground fault . . . . .	43
Bolt-on loadcentre and circuit breaker accessories . . . . .	44
Manual transfer switches/generator panels . . . . .	45
Spa panels . . . . .	47
Surge suppression products . . . . .	48
Stage 1 and Stage 1 Type 2 . . . . .	48
Accessories . . . . .	49
Street lighting panels . . . . .	50
In-pole . . . . .	50
On-pole . . . . .	51
Pedestal . . . . .	52
Combined loadcentre and meter socket . . . . .	53
Metered temporary ground fault power panel . . . . .	54
Mini-power centres . . . . .	55
Plug-in mini-power centres . . . . .	56
Plug-in . . . . .	56
Bolt-on mini-power centres . . . . .	57
Bolt-on . . . . .	57
Residential fuse panel inserts . . . . .	58
Insert interiors . . . . .	59
Trims . . . . .	60
Replacement classic circuit breakers . . . . .	61
Bolt-on Type BQL single-, multi-pole, Duplex and Quadplex . . . . .	61
Bolt-on Type BQL ground fault and moulded case switches . . . . .	62
Bolt-on Type QBH single-, multi-pole and accessories . . . . .	63
Plug-in Type BJ two- and three-pole . . . . .	64
Pressure switches . . . . .	65
Index . . . . .	66

## Type CPM/CPL plug-in loadcentres

### Product description

Loadcentres feature factory installed main lugs or main breakers. The BR interiors are manufactured of formed, plated aluminum. Eaton also supplies a full line of Eaton brand BR, DNPL, GFCB and GFEP type branch circuit breakers and accessories for these loadcentres.

### Product application

Designed for the protection and distribution of single and multi-dwelling residential and light commercial loads to 120/240 volts AC, such as lighting, heating, appliance and small motor branch circuits.

All main breaker combination loadcentres are CSAT listed for use as service entrance equipment.

### Ratings

Single-phase, three-wire, 120/240 volts AC and three-phase, four-wire, 120/208 volts AC. Mains through 400 A. Available with up to 84 branch circuits. Main breakers on 150 and 200 A panels are rated at 25,000 AIC.

### Metal enclosure specifications

Enclosures are made of 16 gauge sheet steel, either galvanized or epoxy painted. These coatings provide superior corrosion protection. All trims used on BR loadcentres are chromate sealed and finished with an electro-disposition epoxy paint in grey (ANSI-61) or white, which exceeds requirements for outdoor and indoor applications. A combination surface/flush cover with integral door is supplied with indoor loadcentres rated from 100 through 400 A.

All plug-in loadcentres are CSA listed to file LL98266. CSA certified to C22.2 No.29.

### Warranty

10 year limited.

## Type CPM/CPL loadcentre features and benefits

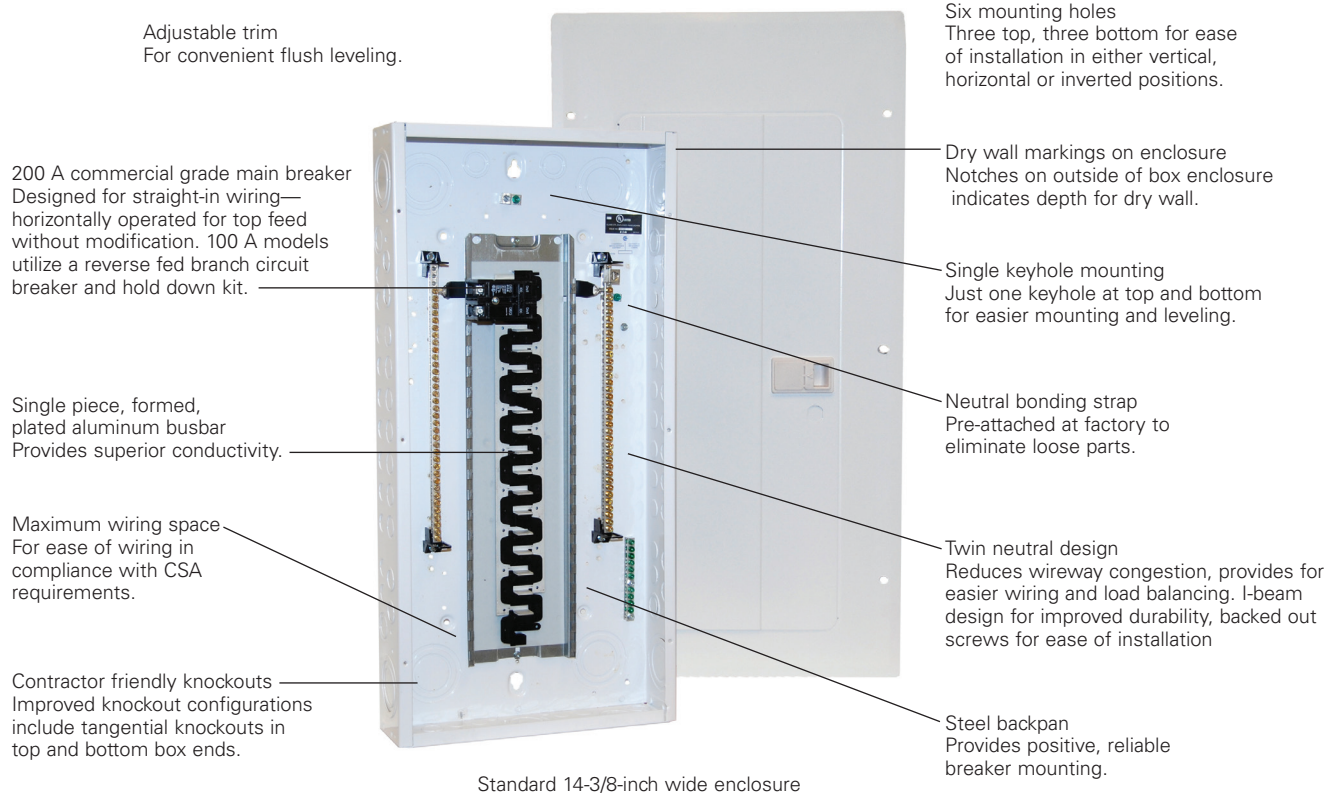

## Type CPM plug-in loadcentres

### Combination (main circuit breaker) single-phase Type 1

Three-wire, 120/240 Vac combination service entrance Type 1 (indoor)

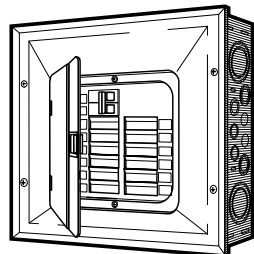

CPM112

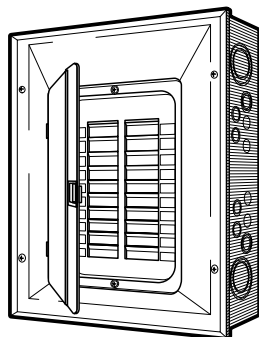

CPM120WL

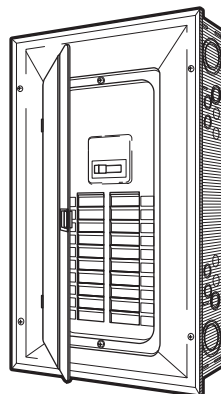

CPM1520

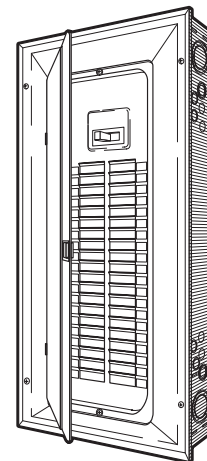

CPM240WL

### Product selection

Table 1. Main circuit breaker indoor Type 1 loadcentres

Maximum ampere rating	Main breaker rating	Catalogue number	Max. no. 1-inch spaces	Max. no. 1/2-inch spaces	Cover style	Type of main breaker	Dimensions (inches)			Wire size range for main CU/AL
							H	W	D	
125	100	CPM112WL <sup>d</sup>	12	24	Flush/surface	BRH <sup>b</sup>	18-3/4	14-3/8	3-7/8	#8-1/0
125	100	CPM116WL <sup>d</sup>	16	32	Flush/surface	BRH <sup>b</sup>	21	14-3/8	3-7/8	#8-1/0
125	125	CPM116Z	16	32	Flush/surface	BRH <sup>c</sup>	21	14-3/8	3-7/8	#4-2/0
125	100	CPM120WL <sup>d</sup>	20	40	Flush/surface	BRH <sup>b</sup>	27	14-3/8	3-7/8	#8-1/0
125	125	CPM120Z	20	40	Flush/surface	BRH <sup>c</sup>	27	14-3/8	3-7/8	#4-2/0
125	100	CPM130WL <sup>d</sup>	30	60	Flush/surface	BRH <sup>b</sup>	29-1/8	14-3/8	3-7/8	#8-1/0
125	125	CPM130Z	30	60	Flush/surface	BRH <sup>c</sup>	29-1/8	14-3/8	3-7/8	#4-2/0
125	100	CPM140WL <sup>d</sup>	40	80	Flush/surface	BRH <sup>b</sup>	34-1/8	14-3/8	3-7/8	#8-1/0
125	125	CPM140Z	40	80	Flush/surface	BRH <sup>b</sup>	34-1/8	14-3/8	3-7/8	#8-1/0
150	150	CPM1520WL <sup>d</sup>	20	40	Flush/surface	CSR <sup>e</sup>	29-1/8	14-3/8	3-7/8	#2-300 MCM
150	150	CPM1530WL <sup>d</sup>	30	60	Flush/surface	CSR <sup>e</sup>	34-1/8	14-3/8	3-7/8	#2-300 MCM
150	150	CPM1540WL <sup>d</sup>	40	80	Flush/surface	CSR <sup>e</sup>	39	14-3/8	3-7/8	#2-300 MCM
200	200	CPM216WL <sup>d</sup>	16	32	Flush/surface	CSR <sup>e</sup>	29-1/8	14-3/8	3-7/8	#2-300 MCM
200	200	CPM220WL <sup>d</sup>	20	40	Flush/surface	CSR <sup>e</sup>	29-1/8	14-3/8	3-7/8	#2-300 MCM
200	200	CPM230WL <sup>d</sup>	30	60	Flush/surface	CSR <sup>e</sup>	34-1/8	14-3/8	3-7/8	#2-300 MCM
200	200	CPM240WL <sup>d</sup>	40	80	Flush/surface	CSR <sup>e</sup>	39	14-3/8	3-7/8	#2-300 MCM
200	200	CPM260	60	120	Flush/surface	CSR <sup>e</sup>	49	14-3/8	3-7/8	#2-300 MCM
400	300	CPM342	42	84	Flush/surface	DK <sup>f</sup>	66-1/2	16-1/8	6-5/16	(2)#2/0-250 MCM or (1)#2/0-500 MCM <sup>h</sup>
400	400	CPM442	42	42 <sup>g</sup>	Flush/surface	DK <sup>f</sup>	66-1/2	16-1/8	6-5/16	(2)#2/0-250 MCM or (1)#2/0-500 MCM <sup>h</sup>

a Type BR—100 A 10 kAIC main circuit breaker is factory installed (BR2100).

b High Interrupting 22 kAIC BRH breakers

c 22 kAIC BRH2125 main breaker is factory installed.

d Suffix WL denotes "white loadcentre" painted tub and trim.

e Factory installed 25 kAIC main breaker.

f DK breaker is a 65 kAIC, factory-sealed breaker.

g Restricted due to available neutrals, extra neutrals are available on **page 15** which will expand available circuitry to a maximum of 84 circuits.

h 3TA401K must be ordered separately for #2/0-500-MCM.

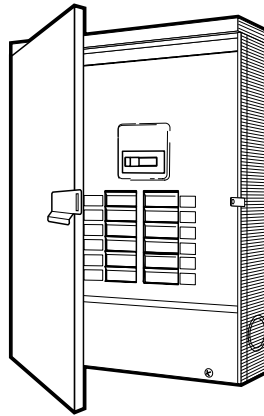
**Combination (main circuit breaker) single-phase Type 3R**Three-wire 120/240 Vac combination service entrance Type 3R (outdoor/raintight) <sup>a</sup>

RCPM220

**Table 2. Main circuit breaker outdoor/raintight Type 3R loadcentres <sup>a</sup>**

Maximum ampere rating	Main breaker rating	Catalogue number	Max. no. 1-inch spaces	Max. no. 1/2-inch spaces	Cover style	Type of main breaker	Dimensions (inches)			Wire size range for main Cu/Al
							H	W	D	
125	100	<b>RCPM112</b> <sup>b</sup>	12	24	Outdoor	BR <sup>cd</sup>	18-1/2	14-3/8	5	#8-1/0
125	100	<b>RCPM120</b> <sup>b</sup>	20	40	Outdoor	BR <sup>cd</sup>	25	14-3/8	5	#8-1/0
125	100	<b>RCPM130</b> <sup>b</sup>	30	60	Outdoor	BR <sup>cd</sup>	28-7/8	14-3/8	5	#8-1/0
150	150	<b>RCPM1530</b> <sup>b</sup>	30	60	Outdoor	CSR <sup>e</sup>	33-7/8	14-3/8	5	#2-300 MCM
200	200	<b>RCPM220</b> <sup>b</sup>	20	40	Outdoor	CSR <sup>e</sup>	28-7/8	14-3/8	5	#2-300 MCM
200	200	<b>RCPM230</b> <sup>b</sup>	30	60	Outdoor	CSR <sup>e</sup>	33-7/8	14-3/8	5	#2-300 MCM
200	200	<b>RCPM240</b> <sup>b</sup>	40	80	Outdoor	CSR <sup>e</sup>	38-3/4	14-3/8	5	#2-300 MCM

<sup>a</sup> Outdoor loadcentres accommodate Type DS conduit hubs. Hubs not included. See **page 15** for selection.

<sup>b</sup> All enclosures include a locking hasp as an integral part of the door latching mechanism.

<sup>c</sup> Type BR—100 A 10 kAIC main circuit breaker is factory installed (BR2100).

<sup>d</sup> High interrupting BRH breakers are available on **page 17**.

<sup>e</sup> Factory installed 25 kAIC main breaker.

**Combination (main circuit breaker) three-phase Type 1**

Four-wire 120/208 Vac combination service entrance Type 1 (indoor)

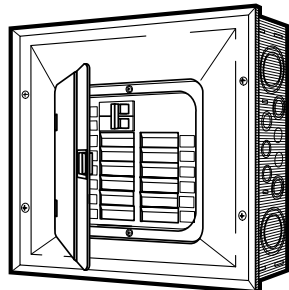

3CPM112

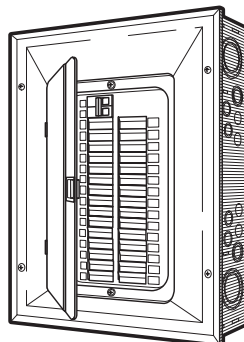

3CPM130

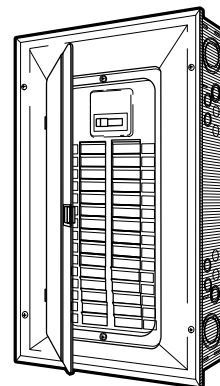

3CPM230

**Table 3. Main circuit breaker indoor Type 1 loadcentres**

Maximum ampere rating	Main breaker rating	Catalogue number	Max. no. 1-inch spaces	Max. no. 1/2-inch spaces	Cover style	Type of main breaker	Dimensions (inches)			Wire size range for main Cu/Al
							H	W	D	
125	100	<b>3CPM112</b>	12	24	Flush/surface	BR <sup>bc</sup>	21	14-3/8	3-3/4	#4-1/0
125	100	<b>3CPM130</b>	30	60	Flush/surface	CC <sup>d</sup>	39	14-3/8	3-3/4	#4-4/0
200	200	<b>3CPM230</b>	30	60	Flush/surface	CC <sup>d</sup>	39	14-3/8	3-3/4	#1-250 MCM
400	400	<b>3CPM442</b> <sup>a</sup>	42	42 <sup>a</sup>	Flush/surface	DK <sup>e</sup>	66-1/2	16-1/8	6-5/16	(2) 2/0-250 MCM (1) 2/0-500 MCM <sup>f</sup>

<sup>a</sup> Extra neutrals which will expand available circuitry to a maximum of 84 circuits are available on [page 15](#).

<sup>b</sup> Type BR—100 A 10 kAIC main circuit breaker is factory installed (BR3100).

<sup>c</sup> High interrupting BRH breakers are available on [page 17](#).

<sup>d</sup> Factory installed 10 kAIC main breaker.

<sup>e</sup> DK Breaker is a 65 kAIC factory-sealed main breaker.

<sup>f</sup> Circuit breaker lug kit 3TA401 must be ordered separately to accept #2/0-500 MCM cabling.

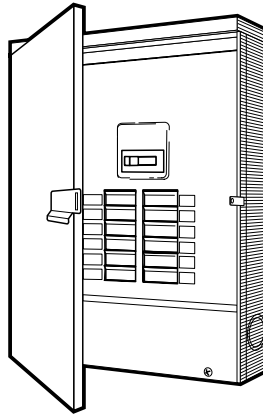

**Combination (main circuit breaker) three-phase Type 3R**Four-wire 120/208 Vac combination service entrance Type 3R (outdoor/raintight) <sup>ab</sup>

R3CPM230

**Table 4. Main circuit breaker outdoor/raintight Type 3R loadcentres** <sup>ab</sup>

Maximum ampere rating	Main breaker rating	Catalogue number	Max. no. 1-inch spaces	Max. no. 1/2-inch spaces	Cover style	Type of main breaker	Dimensions (in)			Wire size range for main Cu/Al
							H	W	D	
100	100	<b>R3CPM112</b> <sup>b</sup>	12	24	Outdoor	BR <sup>cd</sup>	20-3/4	14-3/8	5	#4-1/0
125	100	<b>R3CPM130</b> <sup>b</sup>	30	60	Outdoor	CC <sup>e</sup>	38-3/4	14-3/8	3-3/4	#4-4/0
200	200	<b>R3CPM230</b> <sup>b</sup>	30	60	Outdoor	CC <sup>e</sup>	38-3/4	14-3/8	3-3/4	#1-250 MCM

<sup>a</sup> Outdoor loadcentres accommodate Type DS conduit hubs. Hubs not included. See **page 15** for selection.

<sup>b</sup> All enclosures include a locking hasp as an integral part of the door latching mechanism.

<sup>c</sup> Type BR—100 A 10 kAIC main circuit breaker is factory installed (BR3100).

<sup>d</sup> High interrupting BRH breakers are available on **page 17**.

<sup>e</sup> Factory installed 10 kAIC main breaker.

## Type CPL plug-in loadcentres

### Non-combination (main lug only) single-phase Type 1

Three-wire 120/240 Vac non-combination Type 1 (indoor)

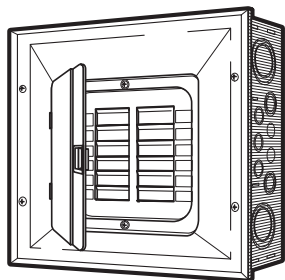

CPL112

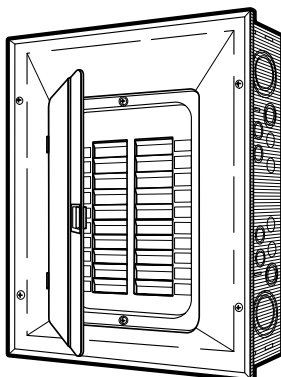

CPL220

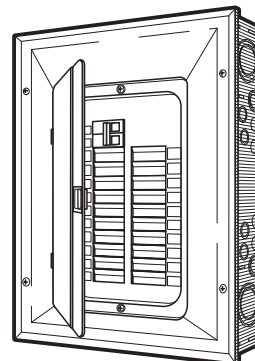

CPL120

### Product selection

**Table 5. Main lug only indoor Type 1 loadcentres**

Maximum Ampere Rating	Catalogue Number	Max. no. 1-inch spaces	Max. no. 1/2-inch spaces	Cover style	Dimensions (inches)			Wire size range for main Cu/Al
					H	W	D	
100	<b>CCPL102</b>	2 <sup>a</sup>	4	Surface	11-1/2	6-3/4	3-1/4	#14-1/0
125	<b>CCPL104</b>	4	8	Flush/surface	13	11	3-1/2	#14-2/0
125	<b>CCPL108</b>	8	16	Flush/surface	13	11	3-1/2	#14-2/0
125	<b>CPL112WL</b> <sup>b</sup>	12	24	Flush/surface	16-3/4	14-3/8	3-7/8	#14-2/0
125	<b>CPL116WL</b> <sup>b</sup>	16	32	Flush/surface	18-3/4	14-3/8	3-7/8	#14-2/0
125	<b>CPL120WL</b> <sup>b</sup>	20	40	Flush/surface	21	14-3/8	3-7/8	#14-2/0
125	<b>CPL130WL</b> <sup>b</sup>	30	60	Flush/surface	29-1/8	14-3/8	3-7/8	#14-2/0
200	<b>CPL220WL</b> <sup>b</sup>	20	40	Flush/surface	27	14-3/8	3-7/8	#1-300 MCM
200	<b>CPL240WL</b> <sup>b</sup>	40	80	Flush/surface	34-1/8	14-3/8	3-7/8	#1-300 MCM
400	<b>CPL442</b>	42	42 <sup>c</sup>	Flush/surface	54	16-1/8	6-5/16	(1) 250-750 MCM (2) 3/0-250 MCM

<sup>a</sup> Service equipment approved when used with two-pole BR type breaker.

<sup>b</sup> Suffix WL Loadcentre comes with a painted white case, trim and door.

<sup>c</sup> Extra neutrals which will expand available circuitry to a maximum of 84 circuits are available on [page 15](#).

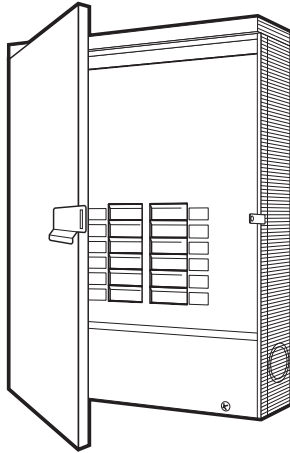
**Non-combination (main lug only) single-phase Type 3R**Three-Wire 120/240 Vac non-combination Type 3R (outdoor/raintight) <sup>a</sup>

RCPL112

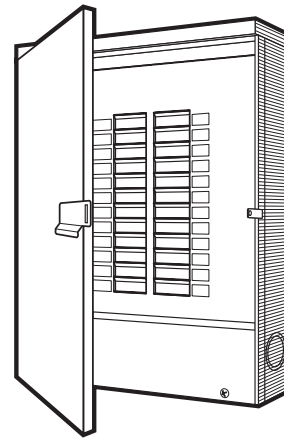

RCPL220

**Table 6. Main lug only outdoor/raintight Type 3R loadcentres <sup>a</sup>**

Maximum ampere rating	Catalogue number	Max. no. 1-inch spaces	Max. no. 1/2-inch spaces	Cover Style	Dimensions (inches)			Wire size range for main Cu/Al
					H	W	D	
125	<b>RCCPL102</b> <sup>b</sup>	2 <sup>c</sup>	4	Outdoor	11-1/2	6-1/2	4	#14-2/0
125	<b>RCCPL104</b> <sup>b</sup>	4	8	Outdoor	13	11	3-1/2	#14-2/0
125	<b>RCCPL108</b> <sup>b</sup>	8	16	Outdoor	13	11	3-1/2	#14-2/0
125	<b>RCPL112</b> <sup>b</sup>	12	24	Outdoor	16-1/2	14-3/8	5	#14-2/0
125	<b>RCPL120</b> <sup>b</sup>	20	40	Outdoor	20-3/4	14-3/8	5	#14-2/0
125	<b>RCPL130</b> <sup>b</sup>	30	60	Outdoor	28-7/8	14-3/8	5	#14-2/0
200	<b>RCPL220</b> <sup>b</sup>	20	40	Outdoor	25	14-3/8	5	#1-300 MCM
200	<b>RCPL240</b> <sup>b</sup>	40	80	Outdoor	33-7/8	14-3/8	5	#1-250 MCM

<sup>a</sup> Outdoor loadcentres accommodate Type DS conduit hubs. Hubs not included. See **page 15** for selection.<sup>b</sup> All enclosures include a locking hasp as an integral part of the door latching mechanism.<sup>c</sup> Service equipment approved when used with two-pole BR type breaker.

**Non-combination (main lug only) three-phase Type 1**

Four-wire 120/208 Vac non-combination Type 1 (indoor)

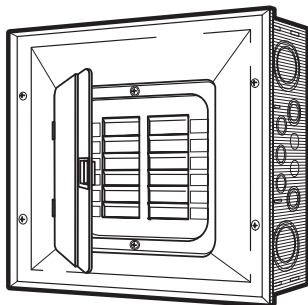

3CPL112

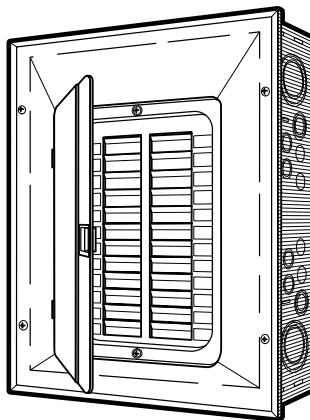

3CPL224

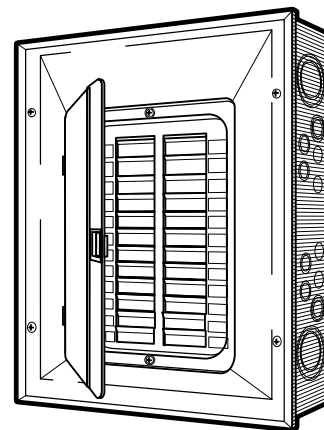

3CPL124

**Table 7. Main lug only indoor Type 1 loadcentres**

Maximum ampere rating	Catalogue number	Max. no. 1-inch spaces	Max. no. 1/2-inch spaces	Cover style	Dimensions (inches)			Wire size range for main Cu/Al
					H	W	D	
100	<b>3CCPL103</b>	3 <sup>a</sup>	6	Surface	14-1/4	6-1/2	3-1/4	#14-2/0
125	<b>3CPL112</b>	12	24	Flush/surface	21	14-3/8	3-7/8	#8-2/0
125	<b>3CPL124</b>	24	48	Flush/surface	29	14-3/8	3-3/4	#8-2/0
125	<b>3CPL130</b>	30	60	Flush/surface	34.12	14-3/8	3-3/4	#8-2/0
125	<b>3CPL136</b>	36	72	Flush/surface	39	14-3/8	3-3/4	#8-2/0
200	<b>3CPL218</b>	18	36	Flush/surface	27	14-3/8	3-7/8	#2-300 MCM
200	<b>3CPL224</b>	24	48	Flush/surface	34.12	14-3/8	3-7/8	#2-300 MCM
200	<b>3CPL230</b>	30	60	Flush/surface	34.12	14-3/8	3-3/4	#2-300 MCM
200	<b>3CPL242</b>	42	84	Flush/surface	39	14-3/8	3-7/8	#2-300 MCM
400	<b>3CPL442</b>	42	42 <sup>b</sup>	Flush/surface	54	16-3/8	6-5/16	(1) 250-750 MCM (2) 3/0-250 MCM

<sup>a</sup> Suitable for use as service equipment when used with three-pole BR type breaker.

<sup>b</sup> Extra neutrals which will expand available circuitry to a maximum of 84 circuits are available on **page 15**.

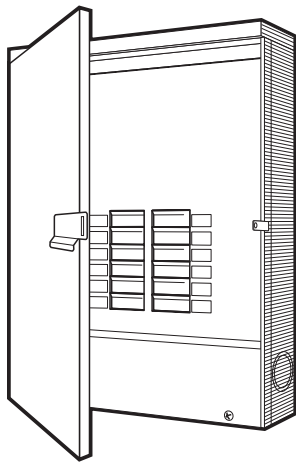
**Non-combination (main lug only) three-phase Type 3R**Four-wire 120/208 Vac non-combination Type 3R (outdoor/raintight) <sup>a</sup>

R3CPL112

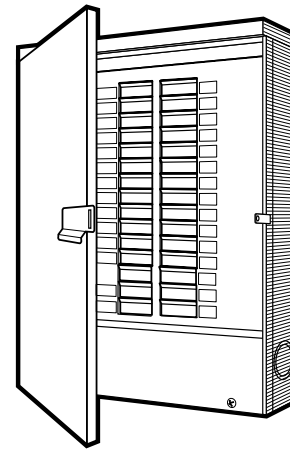

R3CPL230

**Table 8. Main lug only outdoor/raintight Type 3R Loadcentres <sup>a</sup>**

Maximum ampere rating	Catalogue number	Max. no. 1-inch spaces	Max. no. 1/2-inch spaces	Cover style	Dimensions (inches)			Wire size range for main Cu/Al
					H	W	D	
100	<b>R3CCPL103</b> <sup>b</sup>	3 <sup>c</sup>	—	Outdoor	14-1/4	7	3-1/2	#14-2/0
125	<b>R3CPL112</b> <sup>b</sup>	12	24	Outdoor	20-3/4	14-3/8	5	#14-2/0
125	<b>R3CPL130</b> <sup>b</sup>	30	60	Outdoor	38-3/4	14-3/8	5	#14-2/0
125	<b>R3CPL136</b> <sup>b</sup>	36	72	Outdoor	38-3/4	14-3/8	5	#14-2/0
200	<b>R3CPL230</b> <sup>b</sup>	30	60	Outdoor	33-7/8	14-3/8	5	#2-300 MCM
200	<b>R3CPL242</b> <sup>b</sup>	42	42 <sup>d</sup>	Outdoor	38-3/4	14-3/8	5	#2-300 MCM

<sup>a</sup> Outdoor loadcentres accommodate Type DS conduit hubs. Hubs not included. See **page 15** for selection.

<sup>b</sup> All enclosures include a locking hasp as an integral part of the door latching mechanism.

<sup>c</sup> Suitable for use as service equipment when used with three-pole BR type breaker.

<sup>d</sup> Extra neutrals to expand available circuitry to a maximum of 84 circuits are available on **page 15**.

**Non-combination (main lug only) 70 A single-phase**

Three-wire 250 Vac maximum non-combination

Service entrance approved when used with two-pole BR or BRH breakers. <sup>a</sup>

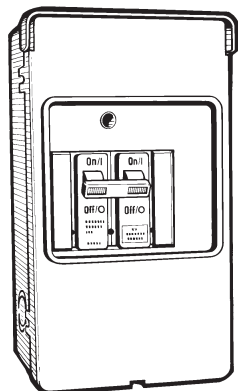

CPL072 indoor



CPL072R outdoor



CPL072FGP flush



CPL072SGP surface



CPL072RGP outdoor

**Table 9. 70 A main lug only polymeric and metallic loadcentres**

Maximum ampere rating	Enclosure style	Material	Catalogue number	Max. no. 1-inch spaces	Max. no. 1/2-inch spaces	Dimensions (inches)			Wire size range for main Cu/Al
						H	W	D	
70	Indoor Type 1 <sup>b</sup>	Polymeric	<b>CPL072</b>	2	4	8-5/8	5	3-1/4	#14-2
70	Indoor/outdoor Type 3R <sup>b</sup>	Polymeric	<b>CPL072R</b> <sup>c</sup>	2	4	8-11/16	6-1/4	4-5/16	#14-2
70	Indoor Type 1 flush mount <sup>b</sup>	Metallic	<b>CPL072FGP</b>	2	4	9-7/16	4-1/2	3	#14-2
70	Indoor Type 1 surface mount <sup>b</sup>	Metallic	<b>CPL072SGP</b>	2	4	9-7/16	4-1/2	3	#14-2
70	Indoor/outdoor Type 3R <sup>b</sup>	Metallic	<b>CPL072RGP</b> <sup>cd</sup>	2	4	9-7/16	4-1/2	3	#14-2

<sup>a</sup> BR and BRH two-pole breakers can be found on **page 17**.

<sup>b</sup> Service entrance approved when used with two-pole BR/BRH breakers.

<sup>c</sup> The circuit breaker protective cover incorporates a locking hasp.

<sup>d</sup> Uses DS\*H1 style hubs found on **page 15**.

## Type CPM/CPL plug-in loadcentre accessories

**Table 10. Plug-in loadcentre accessories**

Description	Catalogue number	Description	Catalogue number
Number strips for CPL/CPM 42 circuits a	<b>NSP42</b>	Door lock for 4–8 circuit 125 A (CPM/CPL)	<b>CH9FL k</b>
Circuit identification labels (e.g. hot water heater) b	<b>BP3110C</b>	Door lock for 12–42 circuit 100–225 A and 400 A (CPM/CPL)	<b>TDL k</b>
Replacement outer trim CPL112WL c	<b>CBRTRIM16</b>	Isolated ground kit	<b>ISGRD</b>
Replacement outer trim CPL116WL, CPM112WL c	<b>CBRTRIM18</b>	Trim screw kit (CPM/CPL) d	<b>CVRSCRW</b>
Replacement outer trim CPL120WL, CPM116WL c	<b>CBRTRIM21</b>	Trim screw kit white (order in quantities of 25)	<b>LCCSW</b>
Replacement outer trim CPL220WL, CPM120WL c	<b>CBRTRIM27</b>	3/4-inch hub for 100–125 A Type 3R loadcentres (3 x 2-3/4 inches) e	<b>DS075H1</b>
Replacement outer trim CPL130WL, CPM130WL, CPM1520WL, CPM216WL, CPM220WL c	<b>CBRTRIM29</b>	1-inch hub for 100–125 A Type 3R loadcentres (3 x 2-3/4 inches) e	<b>DS100H1</b>
Replacement outer trim CPL240WL, CPM140WL, CPM1530WL, CPM230WL c	<b>CBTRTIM34</b>	1-1/4 inch hub for 100–125 A Type 3R loadcentres (3 x 2-3/4 inches) e	<b>DS125H1</b>
Replacement outer trim CPM1540WL, CPM240WL c	<b>CBRTRIM39</b>	1-1/2 inch hub for 100–125 A Type 3R loadcentres (3 x 2-3/4 inches) e	<b>DS150H1</b>
Ground Bar Kit 5 position	<b>GBK5</b>	2-inch hub for 100–125 A Type 3R loadcentres (3 x 2-3/4 inches) e	<b>DS200H1</b>
Ground Bar Kit 8 position	<b>GBK8</b>	2-inch hub for 150 and 200 A Type 3R loadcentres (4-3/4 x 4-5/8 inches)	<b>DS200H2</b>
Ground Bar Kit 10 position	<b>GBK10</b>	2-1/2 inch hub for 150 and 200 A Type 3R loadcentres (4-3/4 x 4-5/8 inches)	<b>DS250H2</b>
Ground Bar Kit 14 position	<b>GBK14</b>	3-inch hub for 150 and 200 A Type 3R loadcentres (4-3/4 x 4-5/8 inches)	<b>DS300H2</b>
Ground Bar Kit 21 position	<b>GBK21</b>	3/4-inch hub for R3CCPL103 loadcentres (2-1/8 x 3-1/4 inches)	<b>RH75P</b>
		1-inch hub for R3CCPL103 loadcentres (2-1/8 x 3-1/4 inches)	<b>RH100P</b>
		1-1/4 inch hub for R3CCPL103 loadcentres (2-1/8 x 3-1/4 inches)	<b>RH125P</b>
		1-inch filler plate kit f	<b>BRFP</b>
		Subfeed kit for 125 A loadcentres #8–2/0 g	<b>BRSF125</b>
		Subfeed kit for 150 A three-phase loadcentres #8–2/0 g	<b>3BRSF150</b>
		Subfeed kit for 225 A loadcentres #2–300 MCM g	<b>BRS225</b>
		Subfeed kit for 225 A three-phase loadcentres #2–300 MCM g	<b>3BRS225</b>
		Subfeed kit for 400 A loadcentres #8–300 MCM g	<b>BRS400</b>
		Subfeed kit for 400 A three-phase loadcentres g	<b>3BRS400</b>
		Neutral/ground lug kit for 2/0 h	<b>NL20</b>
		Neutral/ground lug kit for 3/0 h	<b>NL30</b>
		Neutral/ground lug kit for 300 MCM (maximum) h	<b>NL300</b>
Neutral kit for 400 A non-combination loadcentres j	<b>CPL400KIT</b>	Neutral kit for 400 A combination loadcentres i	<b>CPM400KIT</b>
White plastic replacement door latch	<b>52-3125-6</b>	Grey plastic replacement door latch	<b>52-3125-5</b>
White spray can touch up paint	<b>SPCWH</b>	Grey spray can touch up paint	<b>SPC61</b>

a 25 per package. Catalogue number represents one package.

b 50 per package. Catalogue number represents one package.

c Includes outer trim only, no door, and no deadfront.

d 100 per package. Catalogue number represents one package.

e Except R3CCPL103.

f Kit includes 25 pieces.

g Line/Load terminals supplied only. Neutral conductor must be purchased separately. See above listed kits.

h Neutral bolts to main neutral bar i.e. remove screw and install lug kit.

i Kit includes 2 neutral bars.

j Kit includes 1 neutral bar.

k Comes with a set of keys.

## Plug-in circuit breakers for CPM/CPL

### Type BR, DNPL, GFCB, GFEP, and GFXB

#### BR circuit breakers

Eaton Type BR plug-in breakers in the standard 1-inch per pole moulded case and can be used as main and/or branch disconnect devices. All are CSA and UL listed. Typical ampacity range for BR breakers is 15 through 125 A. <sup>a</sup>

#### FIRE-GUARDE arc fault circuit interrupter (AFCI)

The FIRE-GUARD arc fault circuit interrupter (AFCI) is a residential circuit breaker with an integrated processor which recognizes the unique current and/or voltage signatures associated with arcing faults, and acts to interrupt the circuit to reduce the likelihood of an electrical fire. With the Eaton Fire-Guard AFCI, protection from arcing faults is combined with conventional thermal and magnetic overloads as found in standard residential circuit breakers protecting wiring from excessive heat or damage due to overloading or short circuits. Fire-Guard AFCI can also be equipped with 5 mA ground fault protection to protect from personal shock hazards. Now, there is a residential circuit breaker that provides protection from arcing faults, conductor damage due to thermal overloads and short circuits, as well as 5 mA ground fault protection in one integrated design.

#### GFTCB people protection breakers

Eaton Type GFCB (ground fault circuit breaker) combines state-of-the-art electronic technology with a circuit breaker mechanism in a compact 1-inch per pole moulded case. The GFCB automatically

senses hot wire-to-ground faults in a 4 to 6 mA range and shuts off the power thus providing an extra margin of safety beyond that of conventional circuit breakers. GFCB applications include bathrooms, basement outlets, swimming pools, outdoor branch circuits and kitchen branch circuits. Self testing compliant to new codes. Type GFCB breakers are also available in 30 mA equipment protectors. 30 mA breakers are for equipment requiring a higher interrupting value such as heat tracing.

#### DNPL twin circuit breakers

DNPL plug-in breakers have the same construction as Eaton Type BR 1-inch per pole devices except that two single-pole circuits are provided in a 1-inch space. <sup>a</sup> CSA listed interrupting rating is 10,000 AIC. All ratings are CSA and UL listed.

#### DNPL quad circuit breakers

QuadplexE construction of Eaton Type DNPL plug-in breakers provides various combinations of two-pole and single-pole devices in a 2-inch moulded case. All plug-in breakers are approved for HACR applications. <sup>a</sup>

- All ratings are CSA and UL listed
- CSA certified to C22.2 No. 5, file LR3300
- All loadcentre breakers are GOS listed for conformity

<sup>a</sup> Single-pole 15 and 20 A units are switching duty (SWD) rated.

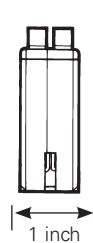
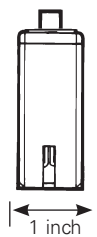
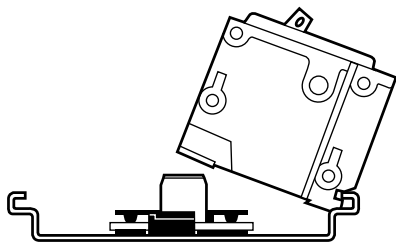
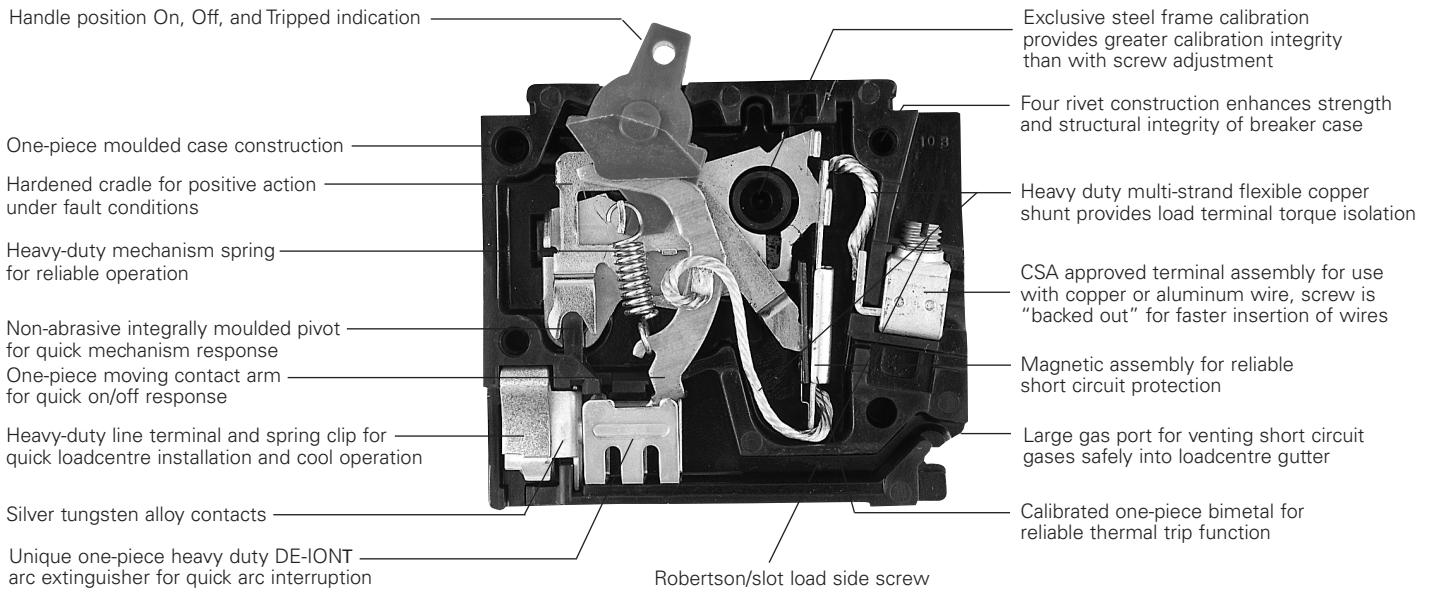



**Type BR single- and multi-pole**Type BR <sup>ab</sup>

- 10,000/22,000 A interrupting capacity at 120 Vac, 120/240 Vac, and 240 Vac
- Two- and three-pole versions feature a common trip



BR120



BR215



BR320

**Table 11. Single- and multi-pole plug-in circuit breakers**

Ampere rating	Wire size range (Cu/Al 60 °C or 75 °C)	Catalogue numbers					
		Single-pole, 120/240 Vac 10 per shelf carton		Two-pole, 120/240 Vac 5 per shelf carton		Three-pole, 120/240 Vac 5 per shelf carton	
		10 kAIC	22 kAIC	10 kAIC	22 kAIC	10 kAIC	22 kAIC
15	#14-4	BR115 <sup>cd</sup>	BRH115	BR215	BRH215	BR315	BRH315
20	#14-4	BR120 <sup>cd</sup>	BRH120	BR220	BRH220	BR320	BRH320
25	#14-4	BR125 <sup>c</sup>	BRH125	BR225	BRH225	BR325	BRH325
30	#14-4	BR130 <sup>c</sup>	BRH130	BR230	BRH230	BR330	BRH330
35	#14-4	BR135 <sup>c</sup>	BRH135	BR235	BRH235	BR335	BRH335
40	#14-4	BR140 <sup>c</sup>	BRH140	BR240	BRH240	BR340	BRH340
45	#14-4	—	BRH145	BR245	BRH245	BR345	BRH345
50	#14-4	BR150 <sup>c</sup>	BRH150	BR250	BRH250	BR350	BRH350
60	#8-1/0	BR160 <sup>c</sup>	BRH160	BR260	BRH260	BR360	BRH360
70	#8-1/0	BR170 <sup>c</sup>	BRH170	BR270	BRH270	BR370	BRH370
80	#8-1/0	—	—	BR280	BRH280	BR380	BRH380
90	#8-1/0	—	—	BR290	BRH290	BR390	BRH390
100	#8-1/0	—	—	BR2100	BRH2100	BR3100	BRH3100
110	#8-1/0	—	—	—	—	—	—
125	#4-2/0 <sup>e</sup>	—	—	BR2125 <sup>e</sup>	—	e	—
150	e	—	—	e	—	e	—
175	e	—	—	e	—	e	—
200	e	—	—	e	—	e	—
Requires one 1-Inch (25.4 mm) space				Requires two 1-Inch (25.4 mm) spaces		Requires three 1-Inch (25.4 mm) spaces	

a All Type BR single-, two-, and three-pole circuit breakers carry listing for HACR application..

b Breaker shunt trips are available but only in 120 Vac format. Addition of a shunt trip adds a 1-inch space width. For circuit breakers requiring a shunt trip add an ST suffix to the end of the catalogue number (e.g. BR115ST).

c Available with high magnetic setting for switching large tungsten lamp loads. Add suffix H to catalogue number (e.g. BR115H).

d Switching duty rated.

e For subfeed applications in 200 or 400 A loadcentres requiring a 125, 150, 175, or 200 A subfeed circuit breaker a Type BJ circuit breaker can be used. Refer to **page 64** for product space requirements and selection.

**Type DNPL Duplex™, Independent Quadplex™ and circuit breaker packs**

Type DNPL <sup>ab</sup>

- 10,000 A interrupting capacity at 120 Vac, 120/240 Vac, and 240 Vac

**Table 12. Duplex and Independent Trip Quadplex plug-in circuit breakers**

Duplex 2 single-pole circuits 10 per shelf carton		Quadplex independent trip 2 single-pole circuits and 1 two-pole circuit 5 per shelf carton				Quadplex independent trip 2 two-pole circuits 5 per shelf carton			
120 Vac		120 Vac	120/240 Vac	120 Vac	120/240 Vac				
Ampere rating	Catalogue number	Outer left (single-pole) ampere rating	Centre (two-pole) ampere rating	Outer right (single-pole) ampere rating	Catalogue number	Outer left and right (two-pole) ampere rating	Centre (two-pole) ampere rating	Catalogue number	Wire size range (Cu/Al 60 °C or 75 °C)
15-15	DNPL1515	15	15	15	DNPL151515	15	15	DNPL215215	#14-4 AWG
15-20	DNPL1520	15	20	15	DNPL152015	15	20	DNPL215220	#14-4 AWG
15-30	DNPL1530	15	25	15	DNPL152515	15	30	DNPL215230	#14-4 AWG
20-20	DNPL2020	15	30	15	DNPL153015	15	40	DNPL215240	#14-4 AWG
—	—	15	40	15	DNPL154015	20	20	DNPL220220	#14-4 AWG
—	—	15	50	15	DNPL155015	20	30	DNPL220230	#14-4 AWG

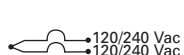

Requires one 1.00 inch (25.4 mm) space

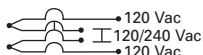

Independent trip requires two 1.00 inch (25.4 mm) spaces

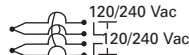

Independent trip requires two 1.00 inch (25.4 mm) spaces

a All Type DNPL Duplex and Quadplex circuit breakers carry listing for HACR applications.

b All 15 and 20 A single-pole are switch-duty rated.

**Type BP (circuit breaker packs)**

- Single carton packaged
- Represents common household combinations



DNPL2020



DNPL155015



DNPL230230

**Table 13. Plug-in circuit breaker house packs**

Contents	Catalogue number
(3) DNPL151515, (1) DNPL153015, (1) DNPL154015	BP2
(10) BR115, (3) BR215, (1) BR230, (1) BR240	BP4
(2) DNPL1515, (1) DNPL215215, (1) DNPL152015, (1) DNPL153015, (1) DNPL154015	BP16
(6) DNPL1515, (2) DNPL151515, (1) DNPL153015, (1) DNPL154015	BP18
(1) DNPL1515, (3) DNPL151515, (2) DNPL153015, (1) DNPL154015	BP21
(3) DNPL1515, (3) DNPL151515, (1) DNPL153015, (1) DNPL154015	BP23
(16) BR115, (3) BR215, (1) BR230, (1) BR240	BP24
(14) BR115, (2) BR120, (1) BR230, (1) BR240	BP27
5 of DNPL1515, 1 of DNPL2020, 1 of DNPL153015, 1 of DNPL154015	BP31
(1) BR120, (4) DNPL1515, (1) DNPL151515, (1) DNPL153015, (1) DNPL154015	BP32
(10) BR115, (2) BR120, (1) BR215, (1) BR220, (1) BR230, (1) BR240	BP41
(3) DNPL1515, (1) DNPL153015, (1) DNPL154015, (1) DNPL2020, (1) DNPL1520	BP54

**Type BR arc fault circuit interrupter**

Type BR arc fault circuit interrupter circuit breakers

- 10,000 A interrupting capacity at 120 Vac, 120/240 Vac, and 240 Vac

An arc fault circuit interrupter is a device intended to provide protection from the effects of arc faults by recognizing characteristics unique to arcing and by functioning to de-energize the circuit when the arc fault is detected. As of January 1, 2015, the Canadian Electrical Code now requires that all branch circuits that supply 125 V, single-phase, 15 and 20 A receptacle outlets installed in dwelling unit shall be protected by a combination arc fault circuit interrupter(s) (series arc and parallel arc detection).

**Table 14. Single- and two-pole plug-in AFCI circuit breakers**

Ampere rating	Configuration	Catalogue number		Wire size range (Cu/Al 60 °C or 75 °C)
		Single-pole 120/240 Vac 20 per shelf carton 10 kAIC	Two-pole <sup>ab</sup> 120/240 Vac 5 per shelf carton 10 kAIC	
15	Branch	<b>BRAF115</b>	—	#14–4 AWG
15	Combination	<b>BRAF115C</b>	—	#14–4 AWG
15	Common trip	—	<b>BRL215CAF</b> cd	#14–4 AWG
15	High interrupting 22 kAIC	<b>BRHCAF115</b>	—	#14–4 AWG
20	Branch	<b>BRAF120</b>	—	#14–4 AWG
20	Combination	<b>BRAF120C</b>	—	#14–4 AWG
20	Common trip	—	<b>BRL220CAF</b> cd	#14–4 AWG
20	High interrupting 22 kAIC	<b>BRHCAF120</b>	—	#14–4 AWG
		Requires one 1.00 inch (25.4 mm) space		Requires two 1.00 inch (25.4 mm) spaces

- a Common trip refers to two-pole 240 V load application sourced by 120/240 Vac (see **Figure 1**).
- b Independent trip refers to two-pole multi-wire, home run or shared neutral circuits (see **Figure 2** and **Figure 4**).
- c Will not fit into CPM112, CPL112, CPL116, CPL120, CPL220, CPL240, 3CPM112, 3CPL218, 3CPL224 or 3CPL230 prior to November 2004.
- d Long style circuit breakers. Please speak to your local Eaton sales rep for proper application.

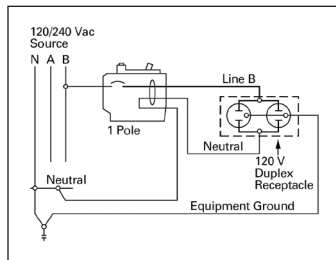

**Figure 1. Single-pole, single 120 V load application sourced by 120/240 Vac**

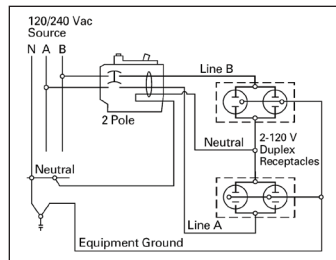

**Figure 2. Two-pole, shared neutral with multi-duplex receptacle application**

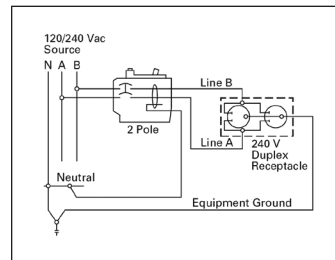

**Figure 3. Two-pole, 240 V load application sourced by 120/240 Vac**

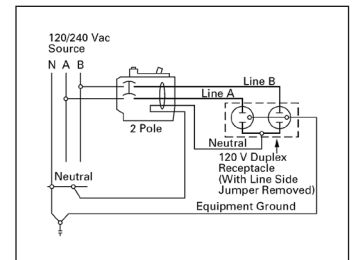

**Figure 4. Two-pole, shared neutral with duplex receptacle application**

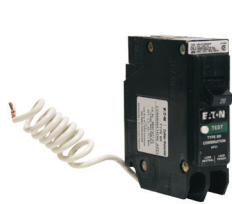

Type BR combination AFCI circuit breaker



Type BR dual purpose AF/GF breaker



Type BR fire alarm breaker features red handle

**Table 15. Single-pole plug-in dual purpose AF/GF breakers**

Ampere rating	Configuration	Single-pole, 120/240 Vac 10 per shelf carton, 10 kAIC Catalogue number
15	CAFCI / 5 mA GF	<b>BRAFGF115C</b>
20	CAFCI / 5 mA GF	<b>BRAFGF120C</b>
Compact body breaker		Requires one 1.00 inch (25.4 mm) space

**Table 16. Single-pole plug-in fire alarm breakers**

Ampere rating	Configuration	Single-pole, 120/240 Vac 10 per shelf carton, 10 kAIC Catalogue number
15	Branch fire alarm	<b>BRF115</b>
20	Branch fire alarm	<b>BRF120</b>
Compact body breaker		Requires one 1.00 inch (25.4 mm) space

**Types GFCB and GFEP ground fault**

**Type GFCB and GFEP ground fault circuit breakers**

- 10,000/22,000 A interrupting capacity at 120 Vac and 120/240 Vac
- 5 mA “people protection”, 10 mA submersible pump protection, or 30 mA equipment protectors
- Two-pole version features common trip



GFTCB single-pole



GFTCB two-pole

**Table 17. 5 mA single- and two-pole plug-in ground fault circuit breakers**

Ampere rating	Wire size range Cu/Al 60 °C or 75 °C (AWG)	Catalogue number				
		Single-pole, 120 Vac 1 per shelf carton		Two-pole, 120/240 Vac 1 per shelf carton		
		10 kAIC	22 kAIC	10 kAIC	22 kAIC	
15	#14–8	GFTCB115 a	GFTCBH115	GFTCB215	GFTCBH215	
20	#14–8	GFTCB120 a	GFTCBH120	GFTCB220	GFTCBH220	
25	#14–8	GFTCB125 a	GFTCBH125	GFTCB225	GFTCBH225	
30	#14–8	GFTCB130 a	GFTCBH130	GFTCB230	GFTCBH230	
40	#14–8	GFTCB140 a	—	GFTCB240	—	
50	#14–8	—	—	GFTCB250 b	—	
60	#14–4	—	—	GFTCB260	—	
			Requires one 1.00 inch (25.4 mm) space		Requires two 1.00 inch (25.4 mm) spaces	

a Auxiliary switches and bell alarms are available under special order. Add suffix W1 for alarm switch and W2 for auxiliary switch.

b For use with copper wire only.

**Table 18. 30 mA single- and two-pole plug-in ground fault circuit breaker equipment protectors**

Ampere rating	Wire size range Cu/Al 60 °C or 75 °C (AWG)	Catalogue number			
		Single-pole, 120 Vac 1 per shelf carton	Two-pole, 120/240 Vac 1 per shelf carton		
		10 kAIC	10 kAIC		
15	#14–8	GFEP115	GFEP215		
20	#14–8	GFEP120	GFEP220		
25	#14–8	GFEP125	GFEP225		
30	#14–8	GFEP130	GFEP230		
40	#14–8	—	GFEP240		
50	#14–8	—	GFEP250 a		
		Requires one 1.00 inch (25.4 mm) space		Requires two 1.00 inch (25.4 mm) spaces	

a For use with copper wire only.

**Ground fault application note**

Single-pole ground fault circuit breakers (GFCBs) are designed for use in two-wire, 120 Vac circuits. **Figure 5** shows a typical wiring configuration. Two-pole GFCBs are designed for use in three-wire, 120/240 Vac circuits, 120 Vac multi-wire circuits employing common, neutral and two-wire, 240 Vac circuits obtained from a 120/240 Vac source. **Figure 6** and **Figure 8** illustrate typical wiring configurations for 120/240 Vac multi-wire circuits. **Figure 7** depicts a 240 Vac, two-wire circuit.

**Note:** The “panel neutral” conductor connects to the neutral bar, even though the neutral is not included in the load circuit. This connection is necessary to supply a 120 Vac power source to the ground fault sensing circuit. The figures are shown with a 120/240 Vac, single-phase, three-wire power source, but are also applicable to a 120/208 Vac, three-phase, four-wire power supply. For all figures, the electrical operation of the GFCB is not affected by the equipment ground.

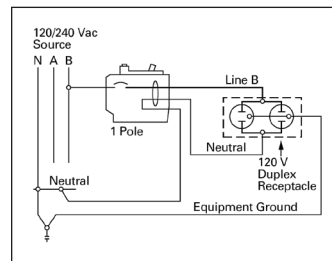

**Figure 5. Single-pole**

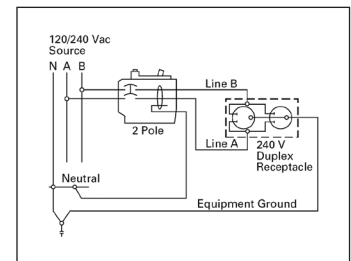

**Figure 7. Two-pole**

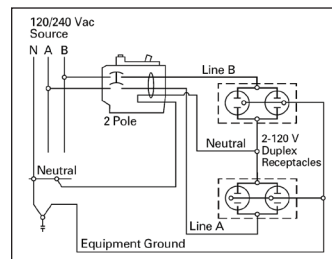

**Figure 6. Two-pole**

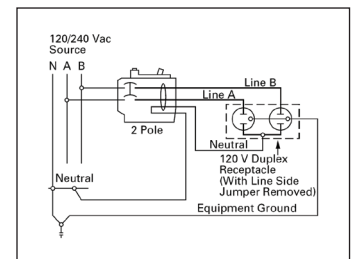

**Figure 8. Two-pole**

**Type GFCB ground fault and Type BR internationally rated**

Type BR internationally rated circuit breakers

- 3000/6000 A interrupting capacity at 240/415 Vac
- Two- and three-pole versions feature common trip



BR120E



BR215E



BR320E

**Table 19. Single-, two-, and three-pole plug-in internationally rated circuit breakers** <sup>ab</sup>

Ampere rating	Wire size range Cu/Al 60 °C or 75 °C (AWG)	Catalogue number					
		Single-pole, 240/415 Vac 10 per shelf carton		Two-pole, 240/415 Vac 5 per shelf carton		Three-pole, 240-415 Vac 5 per shelf carton	
		3 kAIC	6 kAIC	3 kAIC	6 kAIC	3 kAIC	6 kAIC
15	#14-4	BR115E	BRH115E	BR215E	BRH215E	BR315E	BRH315E
20	#14-4	BR120E	BRH120E	BR220E	BRH220E	BR320E	BRH320E
25	#14-4	BR125E	BRH125E	BR225E	BRH225E	BR325E	BRH325E
30	#14-4	BR130E	BRH130E	BR230E	BRH230E	BR330E	BRH330E
35	#14-4	BR135E	BRH135E	BR235E	BRH235E	BR335E	BRH335E
40	#14-4	BR140E	BRH140E	BR240E	BRH240E	BR340E	BRH340E
45	#14-4	—	BRH145E	BR245E	BRH245E	BR345E	BRH345E
50	#14-4	BR150E	BRH150E	BR250E	BRH250E	BR350E	BRH350E
60	#4-1/0	BR160E	BRH160E	BR260E	BRH260E	BR360E	BRH360E
70	#4-1/0	BR170E	BRH170E	BR270E	BRH270E	BR370E	BRH370E
80	#4-1/0	—	—	BR280E	BRH280E	BR380E	BRH380E
90	#4-1/0	—	—	BR290E	BRH290E	BR390E	BRH390E
100	#4-1/0	—	—	BR2100E	BRH2100E	BR3100E	BRH3100E
				Requires one 1.00 inch (25.4 mm) space		Requires two 1.00 inch (25.4 mm) spaces	
						Requires three 1.00 inch (25.4 mm) spaces	

<sup>a</sup> Built to British Standard BS3871.

<sup>b</sup> Non-stocked item requiring special order. Speak to your local Eaton sales rep for lead times.

**Table 20. Duplex, 2 single-pole circuits, 240/415 Vac**

Ampere rating	Catalogue number
15-15	DNPL1515E
15-20	DNPL1520E
20-20	DNPL2020E
—	—
—	—
Requires one 1.00 inch (25.4 mm) space	

**Type GFXB internationally rated ground fault and Type BR moulded case switches**

Type GFXB internationally rated ground fault circuit breakers

- 3000 A interrupting capacity at 120/240 Vac, 220/380 Vac, and 240/415 Vac



Type GFXB

**Table 21. 30 mA single-pole plug-in ground fault circuit breakers** <sup>abc</sup>

Ampere rating	Wire size range Cu/Al 60 °C or 75 °C (AWG)	Catalogue number <sup>a</sup> Single-pole, 120 Vac 1 per shelf carton 3 kAIC
15	#14-4	GFXB115B2
20	#14-4	GFXB120B2
25	#14-4	GFXB125B2
30	#14-4	GFXB130B2

Requires one 1.00 inch (25.4 mm) space

<sup>a</sup> Auxiliary switches and bell alarms are available under special order. Add suffix W1 for alarm switch and W2 for auxiliary switch.

<sup>b</sup> Meets requirements of BS3871 section 31C and BS4293.

<sup>c</sup> Non-stocked part requiring special ordering. Speak to your local Eaton sales rep for lead times.

Type BR non-automatic moulded case switches



BR250NA

**Table 22. Two-pole plug-in non-automatic moulded case switches** <sup>a</sup>

Ampere rating	Wire size range Cu/Al 60 °C or 75 °C (AWG)	Catalogue number <sup>a</sup> Two-pole, 120/240 Vac 5 per shelf carton
50	#4-1/0	BR250NA
60	#4-1/0	BR260NA
100	#4-1/0	BR2100NA

Requires two 1.00 inch (25.4 mm) spaces

<sup>a</sup> Non-stocked part requiring special ordering. Speak to your local Eaton sales rep for lead times.

## Plug-in loadcentre main circuit breakers for CPM/CPL

### Type CSR, and CC

Type CSR loadcentre main circuit breaker kit

- 25,000 A interrupting capacity at 120/240 Vac



CSR2150N

Type CC loadcentre main circuit breaker kit



CC3150

**Table 23. Two-pole main circuit breakers for single-phase plug-in combination loadcentres**

Ampere rating	Wire size range Cu/Al 60 °C or 75 °C	Catalogue number
		Two-pole, 120/240 Vac 1 per shelf carton 25 kAIC
125	#2 AWG–300 kcmil	<b>CSR2125N</b>
150	#2 AWG–300 kcmil	<b>CSR2150N</b>
200	#2 AWG–300 kcmil	<b>CSR2200N</b>

**Table 24. Three-pole main circuit breakers for three-phase plug-in combination loadcentres**

Ampere rating	Wire size range Cu/Al 60 °C or 75 °C	Catalogue number
		Three-pole, 120/240 Vac 1 per shelf carton 10 kAIC
100	#4 AWG–4/0 AWG	<b>CC3100</b>
125	#2 AWG–300 kcmil	<b>CC3125</b>
150	#2 AWG–300 kcmil	<b>CC3150</b>
200	#2 AWG–300 kcmil	<b>CC3200</b>



## Plug-in circuit breaker accessories for CPM/CPL loadcentres

### Plug-in circuit breaker accessories



**Table 25. Field installation kits and parts for plug-in loadcentre circuit breakers**

Description	Ordering quantity <sup>a</sup>	Catalogue number
Handle tie for single-pole Type BR circuit breakers. Joins handles on breakers mounted adjacent to each other via a clip-on mechanism.	1	<b>BQHT-10</b>
Handle tie for Type DNPL circuit breakers. Joins the two outside independent poles on two adjacent duplex or one quadplex circuit breakers.	1	<b>THOW-10</b>
Handle tie for Type DNPL circuit breakers. Joins the outside independent poles on adjacent duplex or quadplex circuit breakers.	1	<b>THS1</b>
Handle lockoff (escutcheon mounted). Single-, two-, or three-pole Type BR; single-pole of a Type DNPL duplex or; one independent outside pole of a Type DNPL quadplex circuit breakers.	1	<b>BRLW-10</b>
Handle lockoff (handle mounted). Single-pole Type BR circuit breakers. <sup>b</sup>	1	<b>BRLW1-10</b>
Handle lockoff (handle mounted). Two- and three-pole Type BR circuit breakers. <sup>b</sup>	1	<b>BRLW2-10</b>
Handle lockoff (handle mounted). Single-pole Type DNPL quadplex circuit breakers. <sup>b</sup>	1	<b>BRDL1-10</b>
Handle lockoff (escutcheon mounted). Two-pole Type DNPL quadplex circuit breakers. <sup>b</sup>	1	<b>BRQLW-10</b>
Handle lockoff (screw mounted). Locks the handle of main circuit breaker types CC and CHH in the OFF or ON position. <sup>b</sup>	1	<b>CCPL</b>
Handle lockoff (escutcheon mounted). Locks the handle of main circuit breaker type CSR and BWH in the OFF or ON position. <sup>b</sup>	1	<b>MCBPL</b>
Handle lockdog (escutcheon mounted). Single-, two-, and three-pole Type BR; single-pole of a Type DNPL duplex or; one independent pole of a Type DNPL quadplex circuit breaker. Secures handle in the ON or OFF position. <sup>b</sup>	1	<b>BHLW-10</b>
Handle lockdog (handle mounted). Single-pole Type BR circuit breakers. Secures handle in the ON or OFF position. <sup>b</sup>	1	<b>BHLW1-10</b>
Handle lockdog (handle mounted). Two- and three-pole Type BR circuit breakers. Secures handle in the ON or OFF position. <sup>b</sup>	1	<b>BHLW2-10</b>
Handle lockdog (handle mounted). Single-pole Type GFCB ground fault circuit breakers. Secures handle in the ON or OFF position. <sup>b</sup>	1	<b>BHGW-10</b>
Handle lockdog (handle mounted). Single-pole Type DNPL duplex or 1 outside independent pole of a quadplex. Secures handle in the ON or OFF position. <sup>b</sup>	1	<b>HLW1-10</b>
Main breaker lug kit. Types CC and CHH circuit breakers (2) 300 kcmil	1	<b>CCL300</b>
Main breaker lug kit. Types CSR, BW, and BWH circuit breakers (2) 300 kcmil	1	<b>MCBL300</b>
Electronic breaker lockoff (escutcheon mounted): Type BR long body AF/GF	1	<b>BRLAFGFLOFF</b>
Electronic breaker lockoff (escutcheon mounted): Type BR compact body AF	1	<b>BRCAFLOFF</b>

<sup>a</sup> Must be purchased in multiples of ordering quantities indicated.

<sup>b</sup> Refer to your local Eaton sales representative for handle position changeability chart.

### Definitions

Handle ties: Devices used to join two similar independent single-pole circuit breakers to form a two-pole non-common trip breaker.

Handle lockoffs: Devices that use a padlock to lock a circuit breaker's handle in either the ON or OFF position.

Handle lockdogs: Devices used to secure a circuit breaker's handle in the ON or OFF position. They are not padlockable devices.

Escutcheon mounted: A semipermanent mounting to the face of the circuit breaker and secured by the loadcentre's deadfront cover.

Handle mounted: A mounting made directly to the handle of the circuit breaker by means of a set screw.

Screw mounted: A permanent mounting to the face of the circuit breaker by means of a non-removable screw.



## Plug-in OEM loadcentre interior assemblies

### Product description

As a leader in the electrical distribution equipment business, Eaton has a unique product offering for equipment manufacturers, panel builders and virtually any OEM that has a need for power distribution within their equipment. The OEM interior offering consists of a wide variety of power distribution options utilizing components from Eaton's BR Loadcentre product lines. With high-volume, standardized products, OEMs can expect to receive high-quality products covering configurations meeting virtually any power distribution need.

Coupled with Eaton's expertise in circuit breaker design and manufacturing, our OEM interiors provide solid power distribution and circuit protection in a compact, easy-to-install package.

### Product offering

The BR interiors are manufactured of formed, plated aluminum, and use the Eaton Type BR 1.00 inch (25.4 mm) wide circuit breaker by Eaton. This design affords customers the most circuit flexibility as many of these interiors allow the installation of standard single- and two-pole breakers as well duplex (two-pole in a 1.00 inch (25.4 mm) space) or quadplex (four-pole in a 2.00 inch (50.8 mm) space) breakers. The stab rating of the BR interiors is 140 A maximum, meaning that the handle rating of the breakers that are mounted across from one another may not exceed 140 A.

The interiors are designed for either horizontal (single-row breaker mounting), or vertical (double-row breaker mounting).

### Product selection

### Standards and certifications

#### Canadian Standards Association listing

All single- and two-pole, 120/240 V breakers, both 1-inch (25.4 mm), 1/2-inch (12.7 mm) and 3/4-inch (19.1 mm) per pole, 225 A maximum, are listed as certified by the Canadian Standards Association, Guide No. 69-11.19, Class 1432, File 18328.

#### Underwriters Laboratories listing

All grounding bars manufactured comply with Underwriters Laboratories standards and are listed under Guide No. DHJR, File E31424, Volume W, Section 17.

All circuit breakers 10 A and larger comply with the Underwriters Laboratories "Standard for Branch Circuit and Service Circuit-Breakers" UL 489; Guide No. 60 10.2 File E31424, and "Requirements for Wire Connectors and Soldering Lugs," UL 486B, Guide No. 461 10-C File E7830.

All Eaton breakers where marked, are suitable for use with 60/75 ° rated wire, unless otherwise specified.

All devices comply with the 22–10 kAIC UL series connected components File DKS2 of the Recognized Components Index.

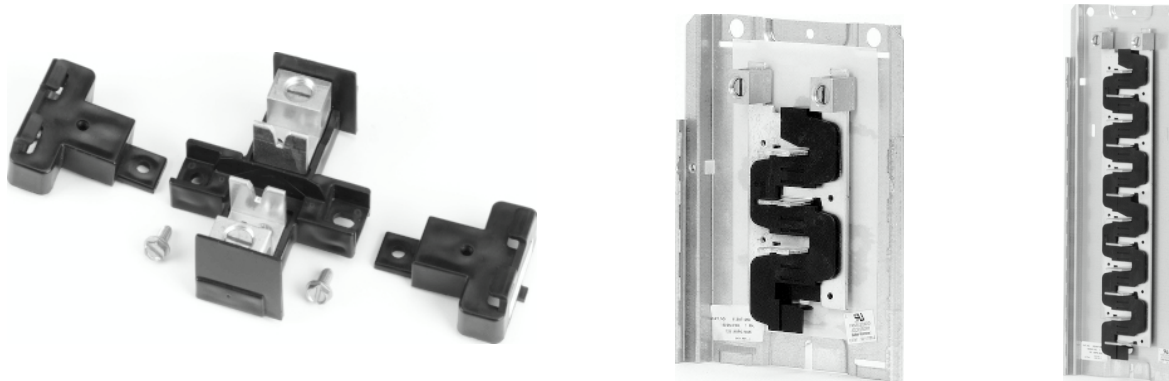

Table 26. Plug-in OEM loadcentre interior assemblies

Ampere rating	1-inch spaces	½-inch spaces	Main terminal size (per phase)	Package quantity	Catalogue number
125	4	8	(1) 2/0-#14 AWG Cu/Al	20	48INT125B
125	8	16	(1) 2/0-#14 AWG Cu/Al	20	816INT125B
125	12	24	(1) 2/0-#14 AWG Cu/Al	20	1224INT125B
125	16	24	(1) 2/0-#14 AWG Cu/Al	20	1624INT125B
125	20	24	(1) 2/0-#14 AWG Cu/Al	10	2024INT125B
125	24	24	(1) 2/0-#14 AWG Cu/Al	10	2424INT125B

Dimensions

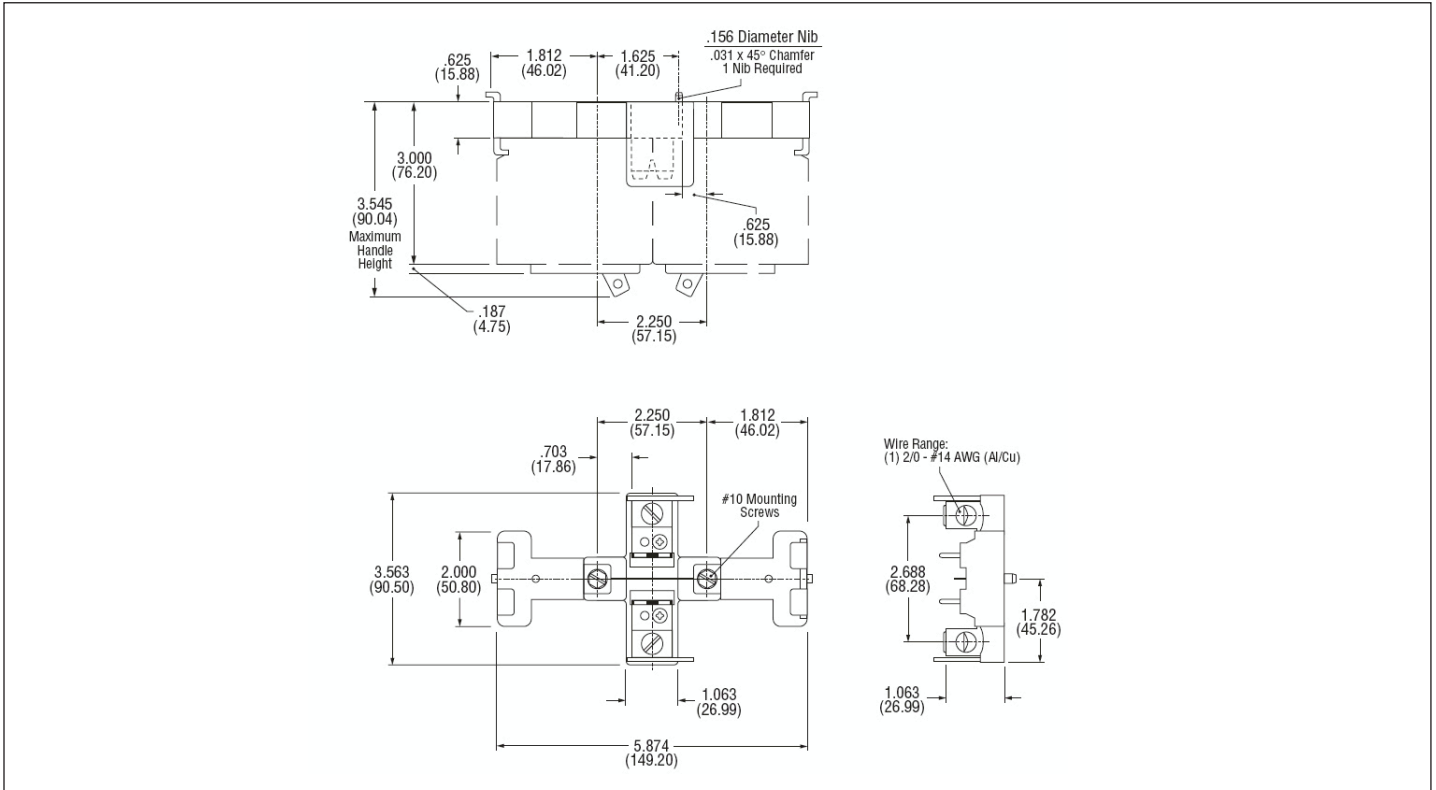

Figure 9. 48INT125B

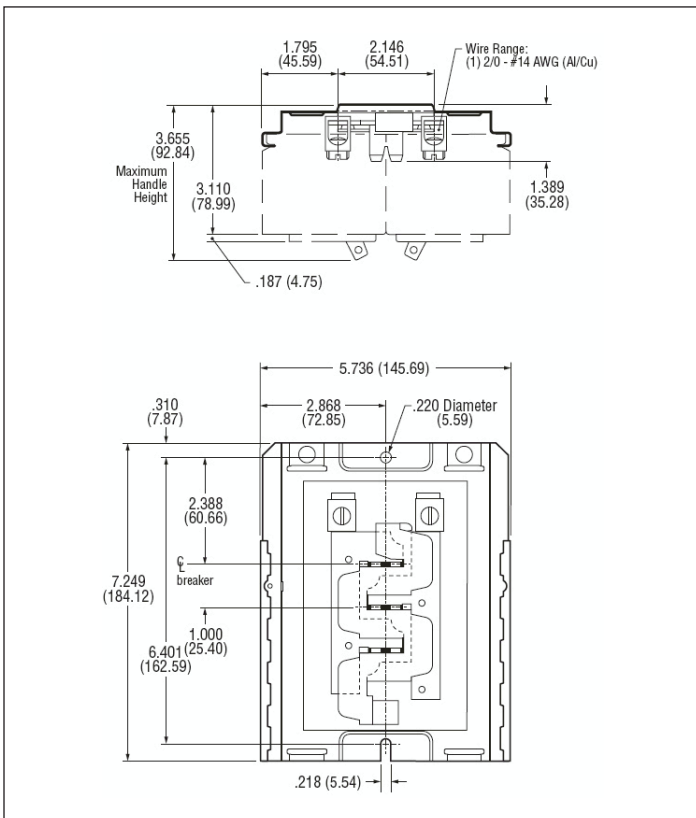

Figure 10. 816INT125B

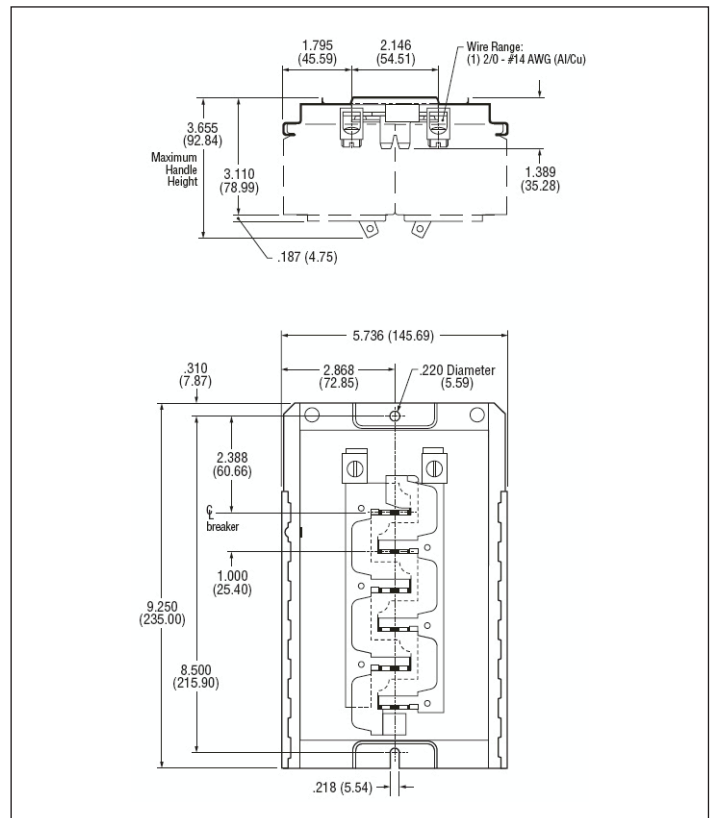

Figure 11. 1224INT125B

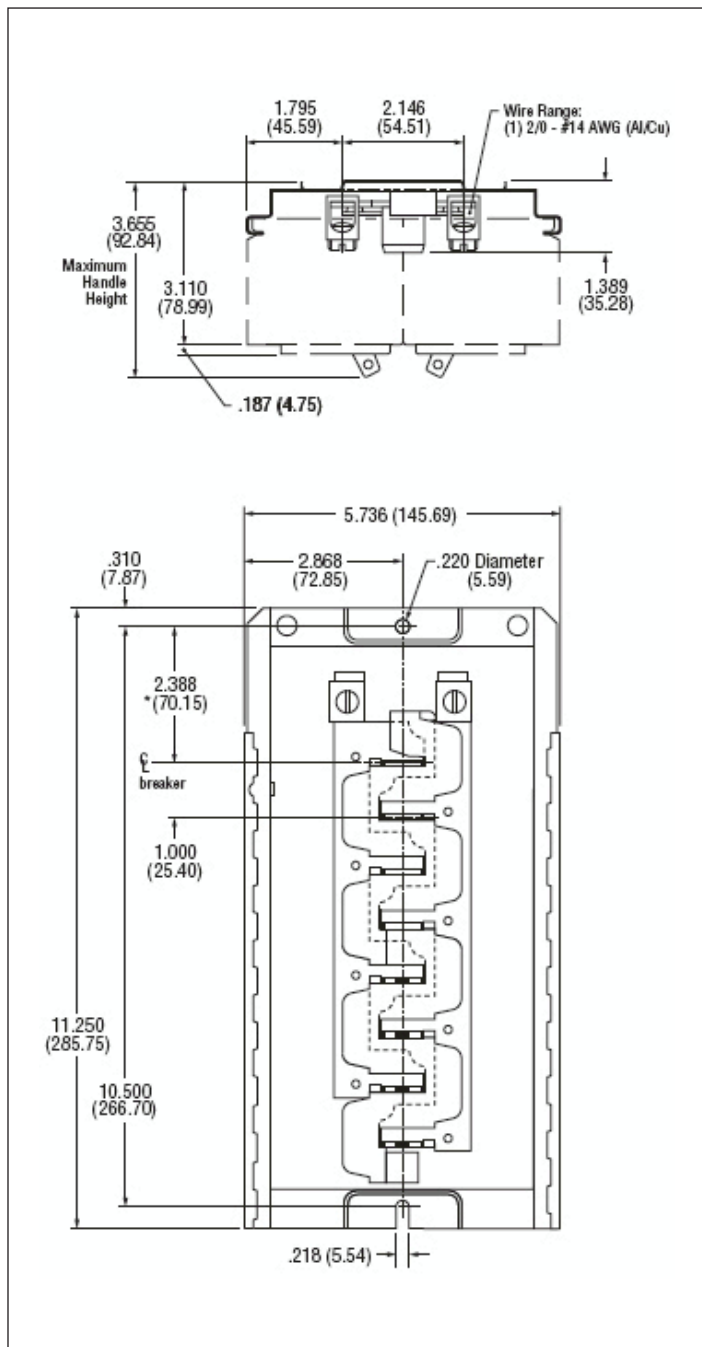

Figure 12. 1624INT125B

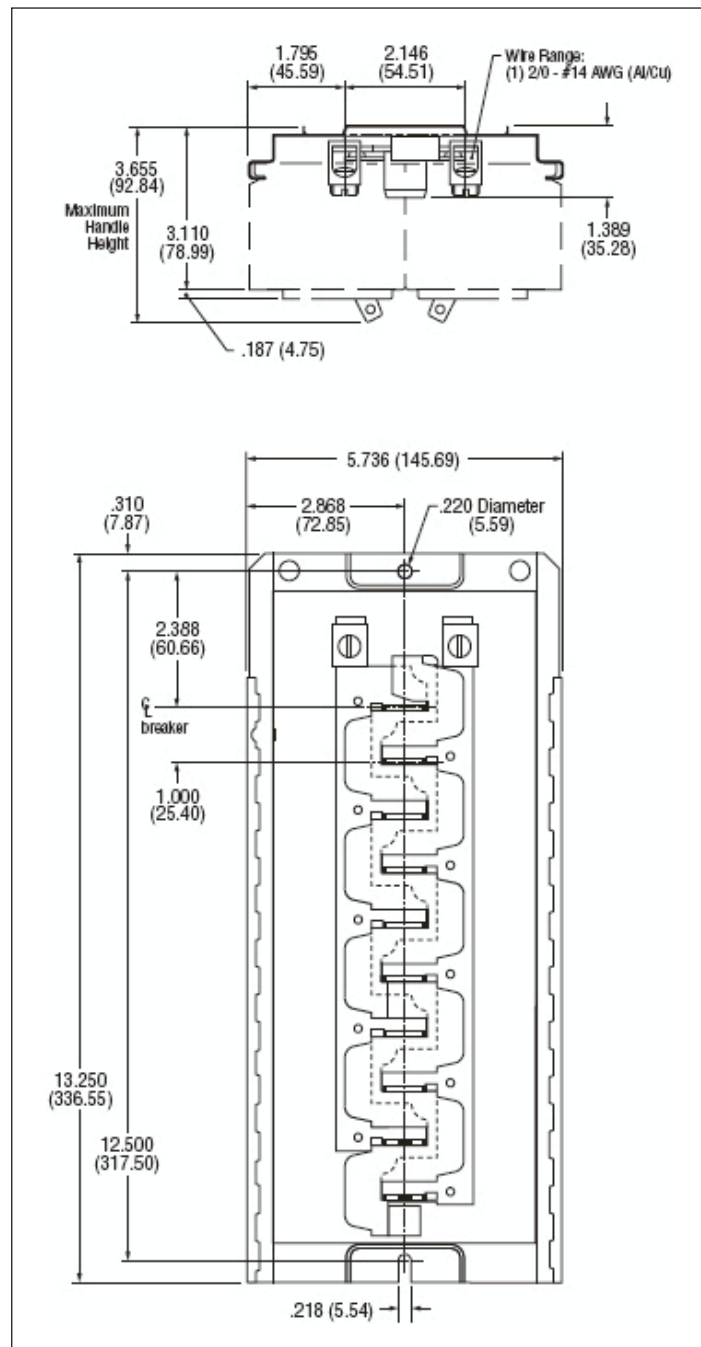

Figure 13. 2024INT125B

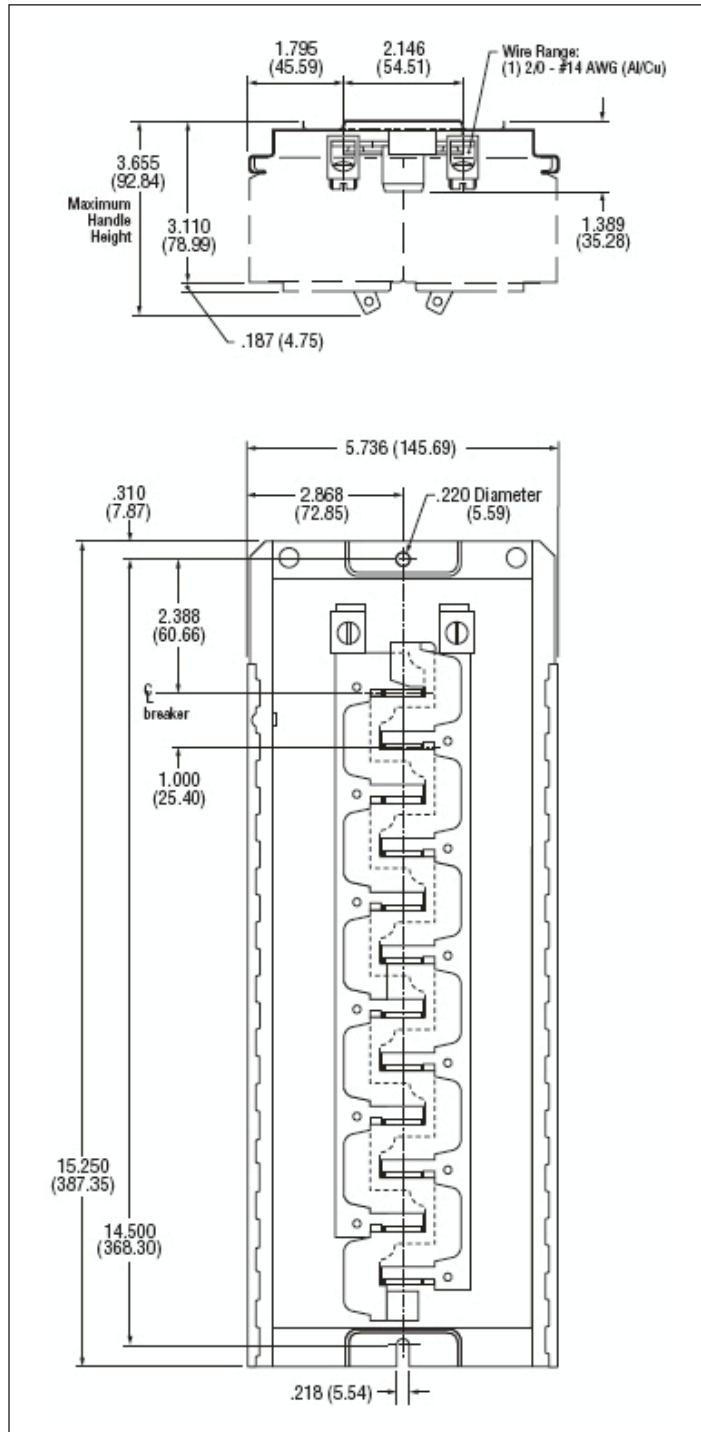

Figure 14. 2424INT125B

## Type CH plug-in loadcentres

### Product description

Loadcentres feature factory installed main lugs or main circuit breakers. The CH interiors are manufactured of formed, silver flash plated copper. Eaton also supplies a full line of Type CH branch circuit breakers and accessories for these loadcentres.

### Product application

Designed for the protection and distribution of single and multi-dwelling residential and light commercial loads to 120/240 volts AC, such as lighting, heating, appliance and small motor branch circuits. All main circuit breaker combination loadcentres are CSA listed for use as service entrance equipment.

### Ratings

Single-phase, three-wire, 120/240 volts AC. Mains through 200 A. Available with up to 120 branch circuits. Main breakers on 100 and 200 A panels are rated at 35,000 AIC.

### Metal enclosure specifications

Enclosures are made of 16 gauge galvanized sheet steel powder coated sandalwood beige. The galvanized coating provides corrosion protection. Trims are similarly scratch-resistant powder coated a sandalwood beige colour to match the tub. A combination surface/flush cover with integral door is supplied.

All plug-in loadcentres are CSA listed to file LL98266.

### Warranty

Limited lifetime.

## Type CH plug-on neutral loadcentre features and benefits

#### Ample cable entry knockouts

- Sidewall, endwall, and backplane locations
- Standard sizing for service entrance and branch circuit cabling

#### Commercial grade main circuit breaker

- 35 kAIC series rated main circuit breaker
- Highest in the industry

#### Attractive sandalwood finish

- Esthetically appealing, scratch-resistant powder coating
- Both tub and trim are painted

#### Silver flash plated copper bus

- Provides superior connectivity

#### Patented stab design

- Unique design provides a tight connection to the bus
- Prevents the misapplication of non-approved branch circuit breakers

#### Large service entrance section

- Straight-in wiring saves labour and material
- Large cable bending space

#### Inboard neutral connections

- Provides direct neutral connection for plug-on style ground fault and arc fault circuit breakers
- Ample additional 2/0 lugs provided—no kits necessary

#### Steel backpan

- Reliable breaker mounting
- One-piece design provides superior stability

#### Drywall marking on enclosure

- Indicates proper mounting depth for flush mounting applications

#### Single keyhole mounting

- One keyhole at the top and bottom provides easier mounting and leveling

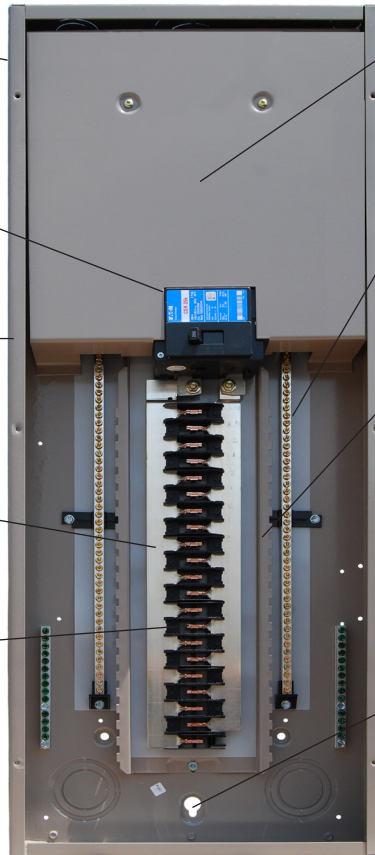

**Combination and non-combination single-phase**

Three-wire 120/240 Vac plug-on neutral style combination service entrance Type 1 (indoor)

**Table 27. Type CH Main circuit breaker plug-on neutral indoor Type 1 loadcentres**

Maximum ampere rating	Main breaker rating	Max. no. 3/4-inch spaces	Cover style	Type of main circuit breaker	Dimensions in inches (mm)			Wire size range for main Cu/Al	Catalogue number
					H	W	D		
100	100	24	Flush/surface	CSR	29.13 (739.8)	14.19 (360.4)	3.69 (93.7)	#2–300 kcmil	<b>CHM24PN100</b>
100	100	32	Flush/surface	CSR	34.13 (866.8)	14.19 (360.4)	3.69 (93.7)	#2–300 kcmil	<b>CHM32PN100</b>
100	100	42	Flush/surface	CSR	37.00 (939.8)	14.19 (360.4)	3.69 (93.7)	#2–300 kcmil	<b>CHM42PN100</b>
200	200	32	Flush/surface	CSR	34.13 (866.8)	14.19 (360.4)	3.69 (93.7)	#2–300 kcmil	<b>CHM32PN200</b>
200	200	42	Flush/surface	CSR	37.00 (939.8)	14.19 (360.4)	3.69 (93.7)	#2–300 kcmil	<b>CHM42PN200</b>
200	200	60	Flush/surface	CSR	39.00 (990.6)	14.19 (360.4)	3.69 (93.7)	#2–300 kcmil	<b>CHM60PN200L</b>

Three-wire 120/240 Vac plug-on neutral style non-combination service entrance Type 1 (indoor)

**Table 28. Type CH main lug only plug-on neutral indoor Type 1 loadcentres**

Maximum ampere rating	Max. no. 3/4-inch spaces	Cover style	Dimensions in inches (mm)			Wire size range for main Cu/Al	Catalogue number
			H	W	D		
125	24	Flush/surface	29.13 (739.8)	14.19 (360.4)	3.69 (93.7)	#2–300 kcmil	<b>CHNL24PN125</b>
125	32	Flush/surface	34.13 (866.8)	14.19 (360.4)	3.69 (93.7)	#2–300 kcmil	<b>CHNL32PN125</b>
225	32	Flush/surface	34.13 (866.8)	14.19 (360.4)	3.69 (93.7)	#2–300 kcmil	<b>CHNL32PN225</b>
225	42	Flush/surface	37.00 (939.8)	14.19 (360.4)	3.69 (93.7)	#2–300 kcmil	<b>CHNL42PN225</b>

Three-wire 120/240 Vac standard neutral non-combination Type 3R (outdoor/raintight) <sup>ab</sup>



CH6L125R



RCCHL102

**Table 29. Type CH main lug only standard neutral outdoor/raintight Type 3R loadcentres <sup>a</sup>**

Maximum ampere rating	Catalogue number	Max. no. 3/4-inch spaces	Max. no. 3/8-inch spaces	Enclosure style	Dimensions in inches (mm)			Wire size range for main CU/AL
					H	W	D	
100	<b>RCCHL102</b>	2	4	Indoor/outdoor Type 3R <sup>ac</sup>	12.00 (304.8)	6.88 (174.62)	4.38 (111.13)	#14–1/0
125	<b>CH6L125R</b>	6	12	Indoor/outdoor Type 3R	12.00 (304.8)	6.88 (174.62)	4.38 (111.13)	#14–1/0

<sup>a</sup> Outdoor loadcentres accommodate Type DS conduit hubs. Hubs not included. See **page 15** for selection.

<sup>b</sup> Does not accept plug-on neutral style of arc fault and ground fault circuit breakers. Uses standard type arc fault and ground fault circuit breakers.

<sup>c</sup> Enclosure assembly incorporates a swing out locking hasp for the cover.

## Plug-in circuit breakers for CH

### Type CH single, multi-pole, and twin

Type CH plug-in circuit breakers <sup>a</sup>

- 10,000 A interrupting capacity at 120/240 Vac
- Flag trip models provide visual indication of trip

Product selection

**Table 30. Single- and multi-pole plug-in breakers**

Ampere rating	Wire size range (Cu/AL 60 °C or 75 °C) (AWG)	Catalogue Number		
		Single-pole, 120/240 Vac Flag trip indication 10 per shelf carton	Two-pole, 120/240 Vac Flag trip indication 5 per shelf carton	Three-pole, 240 Vac Standard 5 per shelf carton
10	(1) #14-8 b, (2) #14-10 bc, (1) #14-6 d	—	—	—
15	(1) #14-8 b, (2) #14-10 bc, (1) #14-6 d	<b>CHF115</b>	<b>CHF215</b>	<b>CH315</b> h
20	(1) #14-8 b, (2) #14-10 bc, (1) #14-6 d	<b>CHF120</b>	<b>CHF220</b>	<b>CH320</b> h
25	(1) #14-8 b, (2) #14-10 bc, (1) #14-6 d	<b>CHF125</b>	<b>CHF225</b>	<b>CH325</b> h
30	(1) #14-8 b, (2) #14-10 bc, (1) #14-6 d	<b>CHF130</b>	<b>CHF230</b>	<b>CH330</b> h
35	#14-2 b, #14-6 d	<b>CHF135</b>	<b>CHF235</b>	<b>CH335</b> h
40	#10-1/0 e, #14-2 f, #3-0 g	<b>CHF140</b>	<b>CHF240</b>	<b>CH340</b> h
45	#10-1/0 e, #14-2 f, #3-0 g	<b>CHF145</b>	<b>CHF245</b>	<b>CH345</b> h
50	#10-1/0 e, #14-2 f, #3-0 g	<b>CHF150</b>	<b>CHF250</b>	<b>CH350</b> h
60	#10-1/0 e, #14-2 f, #3-0 g	<b>CH160</b>	<b>CH260</b>	<b>CH360</b> h
70	#10-1/0 e, #14-2 f, #3-0 g	<b>CH170</b>	<b>CH270</b>	<b>CH370</b> h
80	#10-1/0 e, #14-2 f, #3-0 g	—	<b>CH280</b>	<b>CH380</b>
90	#10-1/0 e, #14-2 f, #3-0 g	—	<b>CH290</b>	<b>CH390</b>
100	#10-1/0 e, #14-2 f, #3-0 g	—	—	<b>CH3100</b>
110	#10-1/0 e, #14-2 f, #3-0 g	—	—	—
125	#10-1/0 e, #14-2 f, #3-0 g	—	—	—

Requires three ¾-inch (19.1 mm) spaces

<sup>a</sup> Not for use in Type BR loadcentres i.e. CPM or CPL prefixed catalogue numbers.

<sup>b</sup> For single- and two-pole breakers.

<sup>c</sup> Solid and stranded wire can be used together.

<sup>d</sup> For three-pole breakers.

<sup>e</sup> Single-pole 60-70 A, two-pole 80-125 A, three-pole 40-100 A.

<sup>f</sup> Single-pole 40-50 A, two-pole 40-70 A.

<sup>g</sup> Two-pole 150 A.

<sup>h</sup> HACR rated.

### Type CH Twin Circuit Breakers <sup>abc</sup>

- 10,000 A interrupting capacity at 120/240 Vac
- Provides 2 single-pole circuits in one ¾-inch space

**Table 31. Twin plug-in circuit breakers**

Ampere rating	Wire size range (Cu/Al 60 °C or 75 °C) (AWG)	Catalogue number
		Single-pole, 120/240 Vac 10 per shelf carton
15-15	#14-8	<b>CHT1515</b>
15-20	#14-8	<b>CHT1520</b>
20-20	#14-8	<b>CHT2020</b>

Requires one ¾-inch (19.1 mm) space

<sup>a</sup> Switching duty rated.

<sup>b</sup> HACR rated.

<sup>c</sup> Not for use in Type BR loadcentres i.e. CPM or CPL prefixed catalogue numbers.



Effective December 2017

**Type CHP commercial**Type CHP commercial circuit breakers <sup>a</sup>

- 10,000 A interrupting capacity at 120 Vac, 120/240 Vac, and 240 Vac
- Three-position trip breakers for commercial applications when On-Off and Trip position is required

**Table 32. Commercial plug-in circuit breakers**

Ampere rating	Wire size range (Cu/Al 60 °C or 75 °C) (AWG)	Catalogue number		
		Single-pole 120/240 Vac 10 per shelf carton	Two-pole 120/240 Vac 5 per shelf carton	Three-pole 240 Vac 5 per shelf carton
10	(1) #14-8 b, (2) #14-10 bc, (1) #14-6 d	<b>CHP110</b>	—	<b>CHP310</b>
15	(1) #14-8 b, (2) #14-10 bc, (1) #14-6 d	<b>CHP115</b> gh	<b>CHP215</b> h	<b>CHP315</b> h
20	(1) #14-8 b, (2) #14-10 bc, (1) #14-6 d	<b>CHP120</b> gh	<b>CHP220</b> h	<b>CHP320</b> h
25	(1) #14-8 b, (2) #14-10 bc, (1) #14-6 d	<b>CHP125</b> h	<b>CHP225</b> h	<b>CHP325</b> h
30	(1) #14-8 b, (2) #14-10 bc, (1) #14-6 d	<b>CHP130</b> h	<b>CHP230</b> h	<b>CHP330</b> h
35	#14-2 b, #14-6 d	<b>CHP135</b> h	<b>CHP235</b> h	<b>CHP335</b> h
40	#10-1/0 e, #14-2 f	<b>CHP140</b> h	<b>CHP240</b> h	<b>CHP340</b> h
45	#10-1/0 e, #14-2 f	<b>CHP145</b> h	<b>CHP245</b> h	<b>CHP345</b> h
50	#10-1/0 e, #14-2 f	<b>CHP150</b> h	<b>CHP250</b> h	<b>CHP350</b> h
60	#10-1/0 e, #14-2 f	— h	<b>CHP260</b> h	<b>CHP360</b> h
70	#10-1/0 e, #14-2 f	—	<b>CHP270</b>	<b>CHP370</b>
80	#10-1/0 e, #14-2 f	—	<b>CHP280</b>	—
90	#10-1/0 e, #14-2 f	—	<b>CHP290</b>	—
100	#10-1/0 e, #14-2 f	—	<b>CHP2100</b>	<b>CHP3100</b>
110	#10-1/0 e, #14-2 f	—	—	—
125	#10-1/0 e, #14-2 f	—	<b>CHP2125</b>	—
		Requires one ¾-inch (19.1 mm) space	Requires two ¾-inch (19.1 mm) spaces	Requires three ¾-inch (19.1 mm) spaces

<sup>a</sup> Not for use in Type BR loadcentres i.e. CPM or CPL prefixed catalogue numbers.

<sup>b</sup> For single- and two-pole breakers.

<sup>c</sup> Solid and stranded wire can be used together.

<sup>d</sup> For three-pole breakers.

<sup>e</sup> Single-pole 60-70 A, two-pole 80-125 A, three-pole 40-100 A.

<sup>f</sup> Single-pole 40-50 A, two-pole 40-70 A.

<sup>g</sup> Switching duty rated.

<sup>h</sup> HACR rated.



**Type CH arc fault circuit interrupter**

Type CH arc fault circuit interrupter circuit breakers <sup>a</sup>

- 10,000 A interrupting capacity at 120 Vac, and 120/240 Vac
- Plug-on neutral style for plug-on neutral type CH loadcentres

A combination type arc fault circuit interrupter is a device intended to mitigate series and parallel arcing faults in the complete circuit, including connected cords. Parallel arcing faults can occur from line to neutral or line to ground. These arcing faults are in parallel with the load and produce the most energy of all arcing faults.

**Table 33. Single- and two-pole plug-in FIRE-GUARDE AFCI circuit breakers**

Ampere rating	Wire size range (Cu/Al 60 °C or 75 °C) (AWG)	Configuration	Catalogue number	
			Single-pole, 120/240 Vac 10 per shelf carton 10 kAIC	Two-pole, 120/240 Vac 5 per shelf carton 10 kAIC <sup>bc</sup>
15	#14-4	Standard	<b>CHFCAF115</b>	—
15	#14-4	Common trip	—	<b>CH215CAF</b>
15	#14-4	Plug-on neutral <sup>d</sup>	<b>CHFCAF115PN</b>	—
20	#14-4	Standard	<b>CHFCAF120</b>	—
20	#14-4	Common trip	—	<b>CH220CAF</b>
20	#14-4	Plug-on neutral <sup>d</sup>	<b>CHFCAF120PN</b>	—
			Requires one ¾-inch (19.1 mm) space	Requires two ¾-inch (19.1 mm) spaces

- <sup>a</sup> Not for use in Type BR loadcentres i.e. CPM or CPL prefixed catalogue numbers.
- <sup>b</sup> Common trip refers to two-pole 240 V load application sourced by 120/240 Vac (see **Figure 17**).
- <sup>c</sup> Independent trip refers to two-pole multi-wire, home run or shared neutral circuits (see **Figure 16** and **Figure 18**).
- <sup>d</sup> Only for use in the Type CH plug-on neutral style of combination and non-combination loadcentres.

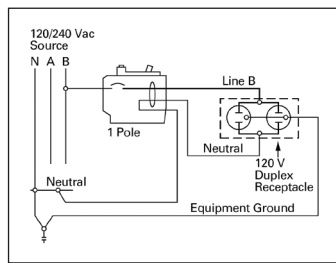

**Figure 15. Single-pole, single 120 V load application sourced by 120/240 Vac**

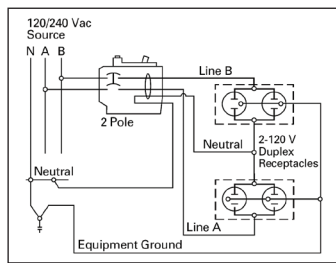

**Figure 16. Two-pole, shared neutral with multi-duplex receptacle application**

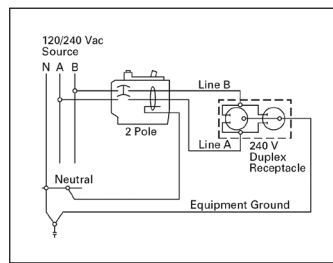

**Figure 17. Two-pole, 240 V load application sourced by 120/240 Vac**

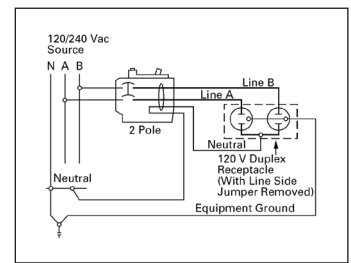

**Figure 18. Two-pole, shared neutral with duplex receptacle application**



Type CH single-pole AFCI circuit breaker



Type CH single-pole dual-purpose AFGF breaker

**Table 34. Single-pole plug-in dual purpose AF/GF circuit breakers**

Ampere rating	Wire size range (Cu/Al 60 °C or 75 °C) (AWG)	Configuration	Catalogue number
			Single-pole 120/240 Vac 10 per shelf carton 10 kAIC
15	#14-4	Standard	<b>CHFAGF115</b>
15	#14-4	Plug-on neutral <sup>a</sup>	<b>CHFAGF115PN</b>
20	#14-4	Standard	<b>CHFAGF120</b>
20	#14-4	Plug-on neutral <sup>a</sup>	<b>CHFAGF120PN</b>
Combination AFCI and 5 mA people protection ground fault			Requires one ¾-inch (19.1 mm) space

- <sup>a</sup> Only for use in the Type CH plug-on neutral style of combination and non-combination loadcentres.

**Type CH ground fault**

Type CH ground fault circuit breakers <sup>a</sup>

- 10,000 A interrupting capacity at 120 Vac and 120/240 Vac
- 5 mA “people protection” or 30 mA equipment protectors
- Two-pole version features common trip

**Table 35. 5 mA single- and two-pole plug-in ground fault circuit breakers**

Ampere rating	Wire size range Cu/Al 60 °C or 75 °C (AWG)	Catalogue number		
		Single-pole, 120 Vac Standard 1 per shelf carton 10 kAIC	Single-pole, 120 Vac Plug-on neutral <sup>b</sup> 1 per shelf carton 10 kAIC	Two-pole 120/240 Vac Standard 1 per shelf carton 10 kAIC
15	#14–6 <sup>c</sup>	CHFGFT115	CHFGFT115PN <sup>b</sup>	CH215GFT
20	#14–6 <sup>c</sup>	CHFGFT120	CHFGFT120PN <sup>b</sup>	CH220GFT
25	#14–6 <sup>c</sup>	CHFGFT125	—	CH225GFT
30	#14–6 <sup>c</sup>	CHFGFT130	CHFGFT130PN	CH230GFT
35	#14–6 <sup>c</sup>	—	—	CH235GFT
40	#14–6 <sup>c</sup>	—	—	CH240GFT
45	#14–6 <sup>c</sup>	—	—	CH245GFT
50	#14–6 <sup>c</sup>	—	—	CH250GFT
60	#14–6 <sup>c</sup>	—	—	CH260GFT
		Requires one ¾-inch (19.1 mm) space		Requires two ¾-inch (19.1 mm) spaces

<sup>a</sup> Not for use in Type BR loadcentres i.e. CPM or CPL prefixed catalogue numbers.  
<sup>b</sup> Only for use in the Type CH plug-on neutral style of combination and non-combination loadcentres.  
<sup>c</sup> 60 A breaker listed for 75 °C Cu wire only.

**Table 36. 30 mA single- and two-pole plug-in ground fault circuit breaker equipment protectors**

Ampere rating	Wire size range Cu/Al 60 °C or 75 °C (AWG)	Catalogue number	
		Single-pole, 120 Vac 1 per shelf carton 10 kAIC	Two-pole, 120/240 Vac 1 per shelf carton 10 kAIC
15	#14–6 <sup>a</sup>	CHFEP115	CH215EPD
20	#14–6 <sup>a</sup>	CHFEP120	CH220EPD
25	#14–6 <sup>a</sup>	CHFEP125	—
30	#14–6 <sup>a</sup>	CHFEP130	CH230EPD
40	#14–6 <sup>a</sup>	—	CH240EPD
50	#14–6 <sup>a</sup>	—	CH250EPD
60	#14–6 <sup>a</sup>	—	CH260EPD
		Requires one ¾-inch (19.1 mm) space	Requires two ¾-inch (19.1 mm) spaces

<sup>a</sup> 60 A breaker listed for 75 °C Cu wire only.

**Ground fault application**

Single-pole ground fault circuit breakers (Type CHGFIs) are designed for use in two-wire, 120 Vac circuits. **Figure 19** shows a typical wiring configuration. Two-pole ground fault circuit breakers (Type CHGFIs) are designed for use in three-wire, 120/240 Vac circuits, 120 Vac multi-wire circuits employing common, neutral and two-wire, 240 Vac circuits obtained from a 120/240 Vac source. **Figure 20** and **Figure 21** illustrate typical wiring configurations for 120/240 Vac multi-wire circuits. **Figure 22** depicts a 240 Vac, two-wire circuit. Note the “panel neutral” conductor connects to the neutral bar, even though the neutral is not included in the load circuit. This connection is necessary to supply a 120 Vac power source to the ground fault sensing circuit. The figures are shown with a 120/240 Vac, single-phase, three-wire power source, but are also applicable to a 120/208 Vac, three-phase, four-wire power supply. For all figures the electrical operation of the Type CHGFI is not affected by the equipment ground.



Type CH two-pole GFCI circuit breaker

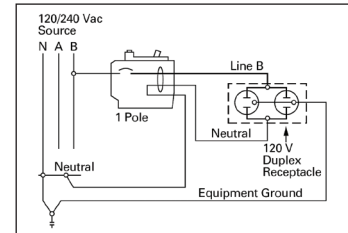

**Figure 19. Single-pole single 120 V duplex receptacle application**

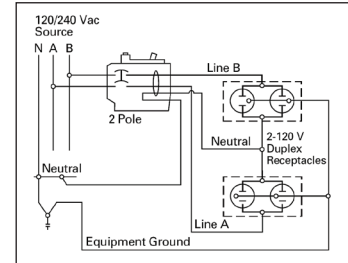

**Figure 20. Two-pole 120 V multi-duplex receptacle application**

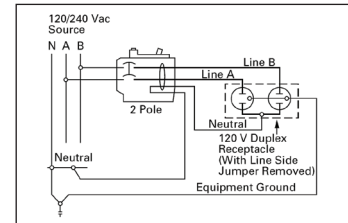

**Figure 21. Two-pole 120 V duplex receptacle application**

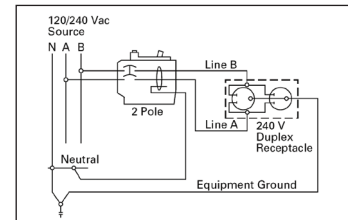

**Figure 22. Two-pole 240 V duplex receptacle application**

## Plug-in loadcentre main circuit breakers for CH

### Type CSR

Type CSR loadcentre main circuit breaker kit

- 25,000 A interrupting capacity at 120/240 Vac



CSR2150N

### Product selection

**Table 37. Two-pole main circuit breakers for single-phase plug-in combination loadcentres**

Ampere rating	Wire size range Cu/Al 60 °C or 75 °C	Catalogue number
		Two-pole, 120/240 Vac 1 per shelf carton 25 kAIC
100	#2 AWG–300 kcmil	CSR2100N
125	#2 AWG–300 kcmil	CSR2125N
150	#2 AWG–300 kcmil	CSR2150N
200	#2 AWG–300 kcmil	CSR2200N

## Plug-in loadcentres and circuit breaker accessories for CH

### Type CH accessories

Plug-in loadcentre and circuit breaker accessories for CH

Product selection

**Table 38. Field installation kits and parts for plug-in loadcentres and circuit breakers**

Description	Ordering quantity <sup>a</sup>	Catalogue number
Handle tie for single-pole Type CH circuit breakers. Joins handles on breakers mounted adjacent to each other via a moulded plastic handle cover.	1	CHHT
Handle lockoff (escutcheon mounted). Single- or two-pole Type CH circuit breakers.	1	CHPL
Handle lockoff (escutcheon mounted). Single- or two-pole Type CHGFI circuit breakers.	1	CHPLGF
Handle lockoff (escutcheon mounted). Locks the handle of main circuit breaker type CSH in the OFF or ON position.	1	MCBPL
Handle lockdog (handle mounted). Single-pole Type CH circuit breakers. Secures handle in the ON or OFF position.	1	CHLO
Subfeed kit for 125 A loadcentres. Requires two 3/4-inch (19.1 mm) spaces.	1	CHSF2125
3/4-inch (19.1 mm) filler plate kit <sup>a</sup>	1	CHFP <sup>a</sup>
Door lock for 24–60 circuit 100 and 200 A (CH)	1	TDL <sup>b</sup>
Trim screw kit (CH)	1	LCSS <sup>c</sup>
Sandalwood plastic replacement door latch	1	CHRLS
Branch circuit numbering strip kit for CH	1	CHMS <sup>d</sup>
Electronic breaker lockoff (escutcheon mounted) for type CHFCAF and CHFAGF		CHFAGFLOFF

<sup>a</sup> Kit includes 25 pieces.

<sup>b</sup> Comes with a set of keys.

<sup>c</sup> Kit includes 25 pieces.

<sup>d</sup> Kit includes 20 pieces.

### Definitions

Handle ties: Devices used to join two similar independent single-pole circuit breakers to form a two-pole non-common trip breaker.

Handle lockoffs: Devices that use a padlock to lock a circuit breaker's handle in either the ON or OFF position.

Handle lockdogs: Devices used to secure a circuit breaker's handle in the ON or OFF position. They are not padlockable devices.

Escutcheon mounted: A semipermanent mounting to the face of the circuit breaker and secured by the loadcentre's deadfront cover.

Handle mounted: A mounting made directly to the handle of the circuit breaker by means of a set screw.

Screw mounted: A permanent mounting to the face of the circuit breaker by means of a non-removable screw.

## Type CBM bolt-on loadcentres

### Combination Service Entrance (main circuit breaker) single- and three-phase aluminum bus

Single-phase 120/240 Vac Type 1 (indoor) loadcentres combination service entrance

- CSA certified only (not UL approved)
- Utilize Type BAB, QBHW, QBA, DNBA, or QBGF circuit breakers as branch circuit breakers



3CBM242

#### Product selection

**Table 39. Single-phase, three-wire 120/240 Vac aluminum bus loadcentres**

Maximum ampere rating	Main breaker rating	Max. no. 1-inch spaces	Max. no. 1/2-inch spaces	Cover style	Dimensions in inches (mm)			Wire size range for main Cu/Al	Catalogue number
					H	W	D		
125	100	18	36	Flush/surface	27.00 (685.8)	14.25 (361.9)	3.75 (95.3)	#8-#1 Cu / #8-1/0 Al	<b>CBM118</b> <sup>a</sup>
125	100	30	60	Flush/surface	34.13 (866.8)	14.25 (361.9)	3.75 (95.3)	#8-#1 Cu / #8-1/0 Al	<b>CBM130</b> <sup>a</sup>
125	100	42	84	Flush/surface	39.00 (990.6)	14.25 (361.9)	3.75 (95.3)	#8-#1 Cu / #8-1/0 Al	<b>CBM142</b> <sup>a</sup>
225	200	18	36	Flush/surface	34.13 (866.8)	14.25 (361.9)	3.75 (95.3)	#4-4/0	<b>CBM218</b> <sup>b</sup>
225	200	30	60	Flush/surface	39.00 (990.6)	14.25 (361.9)	3.75 (95.3)	#4-4/0	<b>CBM230</b> <sup>b</sup>
225	200	42	84	Flush/surface	45.00 (1143.0)	14.25 (361.9)	3.75 (95.3)	#4-4/0	CBM242 <sup>b</sup>

<sup>a</sup> BAB2100 main circuit breaker factory installed.

<sup>b</sup> ED2200 main circuit breaker factory installed.

### Three-phase Combination service entrance 240 Vac Type 1 (indoor) loadcentres

- CSA certified only (not UL approved)
- Utilize Type BAB, QBHW, QBA, DNBA, or QBGF circuit breakers as branch circuit breakers

**Table 40. Three-phase, four-wire 240 Vac maximum aluminum bus loadcentres**

Maximum ampere rating	Main breaker rating	Max. no. 1-inch spaces	Max. no. 1/2-inch spaces	Cover style	Dimensions in inches (mm)			Wire size range for main Cu/Al	Catalogue number
					H	W	D		
125	100	18	36	Flush/surface	27.00 (685.8)	14.25 (361.9)	3.75 (95.3)	#8-#1 Cu / #8-1/0 Al	<b>3CBM118</b> <sup>a</sup>
125	100	30	60	Flush/surface	34.13 (866.8)	14.25 (361.9)	3.75 (95.3)	#8-#1 Cu / #8-1/0 Al	<b>3CBM130</b> <sup>a</sup>
125	100	42	84	Flush/surface	39.00 (990.6)	14.25 (361.9)	3.75 (95.3)	#8-#1 Cu / #8-1/0 Al	<b>3CBM142</b> <sup>a</sup>
225	200	18	36	Flush/surface	34.13 (866.8)	14.25 (361.9)	3.75 (95.3)	#4-4/0	<b>3CBM218</b> <sup>b</sup>
225	200	30	60	Flush/surface	39.00 (990.6)	14.25 (361.9)	3.75 (95.3)	#4-4/0	<b>3CBM230</b> <sup>b</sup>
225	200	42	84	Flush/surface	45.00 (1143.0)	14.25 (361.9)	3.75 (95.3)	#4-4/0	<b>3CBM242</b> <sup>b</sup>

<sup>a</sup> BAB3100H main circuit breaker factory installed.

<sup>b</sup> ED3200 main circuit breaker factory installed.

**Combination (main circuit breaker) single- and three-phase copper bus****Single-phase 120/240 Vac Type 1 (indoor) loadcentres combination service entrance**

- CSA certified only (not UL approved)
- Utilize Type BAB, QBHW, QBA, DNBA, or QBGF circuit breakers as branch circuit breakers

**Table 41. Single-phase, three-wire 120/240 Vac copper bus loadcentres**

Maximum ampere rating	Main breaker rating	Max. no. 1-inch spaces	Max. no. 1/2-inch spaces	Cover style	Dimensions in inches (mm)			Wire size range for main Cu/Al	Catalogue number
					H	W	D		
125	100	18	36	Flush/surface	27.00 (685.8)	14.25 (361.9)	3.75 (95.3)	#8-#1 Cu / #8-1/0 Al	<b>CBM118CU</b> <sup>a</sup>
125	100	30	60	Flush/surface	34.13 (866.8)	14.25 (361.9)	3.75 (95.3)	#8-#1 Cu / #8-1/0 Al	<b>CBM130CU</b> <sup>a</sup>
125	100	42	84	Flush/surface	39.00 (990.6)	14.25 (361.9)	3.75 (95.3)	#8-#1 Cu / #8-1/0 Al	<b>CBM142CU</b> <sup>a</sup>
225	200	18	36	Flush/surface	34.13 (866.8)	14.25 (361.9)	3.75 (95.3)	#4-4/0	<b>CBM218CU</b> <sup>b</sup>
225	200	30	60	Flush/surface	39.00 (990.6)	14.25 (361.9)	3.75 (95.3)	#4-4/0	<b>CBM230CU</b> <sup>b</sup>

<sup>a</sup> BAB2100 main circuit breaker factory installed.

<sup>b</sup> ED2200 main circuit breaker factory installed.

**Three-phase combination service entrance 240 Vac Type 1 (indoor) loadcentres**

- CSA certified only (not UL approved)
- Utilize Type BAB, QBHW, QBA, DNBA, or QBGFT circuit breakers as branch circuit breakers

**Table 42. Three-phase, four-wire 240 Vac maximum copper bus loadcentres**

Maximum ampere rating	Main breaker rating	Max. no. 1-inch spaces	Max. no. 1/2-inch spaces	Cover style	Dimensions in inches (mm)			Wire size range for main Cu/Al	Catalogue number
					H	W	D		
125	100	18	36	Flush/surface	27.00 (685.8)	14.25 (361.9)	3.75 (95.3)	#8-#1 Cu / #8-1/0 Al	<b>3CBM118CU</b> <sup>a</sup>
125	100	30	60	Flush/surface	34.13 (866.8)	14.25 (361.9)	3.75 (95.3)	#8-#1 Cu / #8-1/0 Al	<b>3CBM130CU</b> <sup>a</sup>
125	100	42	84	Flush/surface	39.00 (990.6)	14.25 (361.9)	3.75 (95.3)	#8-#1 Cu / #8-1/0 Al	<b>3CBM142CU</b> <sup>a</sup>
225	200	30	60	Flush/surface	39.00 (990.6)	14.25 (361.9)	3.75 (95.3)	#4-4/0	<b>3CBM230CU</b> <sup>b</sup>

<sup>a</sup> BAB3100H main circuit breaker factory installed.

<sup>b</sup> ED3200 main circuit breaker factory installed.

**Non-combination (main lug only) single- and three-phase aluminum bus**

## Single-phase 120/240 Vac Type 1 (indoor) loadcentres

- CSA certified only (not UL approved)
- Utilize Type BAB, QBHW, QBA, DNBA, or QBGF circuit breakers as branch circuit breakers



CBL130

**Table 43. Single-phase, three-wire 120/240 Vac aluminum bus loadcentres**

Maximum ampere rating	Max. no. 1-inch spaces	Max. no. 1/2-inch spaces	Cover style	Dimensions in inches (mm)			Wire size range for main Cu/Al	Catalogue number
				H	W	D		
125	18	36	Flush/surface	27.00 (685.8)	14.25 (361.9)	3.75 (95.3)	#6–300 MCM	<b>CBL118</b>
125	30	60	Flush/surface	34.13 (866.8)	14.25 (361.9)	3.75 (95.3)	#6–300 MCM	<b>CBL130</b>
125	42	84	Flush/surface	39.00 (990.6)	14.25 (361.9)	3.75 (95.3)	#6–300 MCM	<b>CBL142</b>
225	18	36	Flush/surface	27.00 (685.8)	14.25 (361.9)	3.75 (95.3)	#6–300 MCM	<b>CBL218</b>
225	30	60	Flush/surface	34.13 (866.8)	14.25 (361.9)	3.75 (95.3)	#6–300 MCM	<b>CBL230</b>
225	42	84	Flush/surface	39.00 (990.6)	14.25 (361.9)	3.75 (95.3)	#6–300 MCM	<b>CBL242</b>

## Three-phase 240 Vac Type 1 (indoor) loadcentres

- CSA certified only (not UL approved)
- Utilize Type BAB, QBHW, QBA, DNBA, or QBGF circuit breakers as branch circuit breakers

**Table 44. Three-phase, four-wire 240 Vac aluminum bus loadcentres**

Maximum ampere rating	Max. no. 1-inch spaces	Max. no. 1/2-inch spaces	Cover style	Dimensions in inches (mm)			Wire size range for main Cu/Al	Catalogue number
				H	W	D		
125	18	36	Flush/surface	27.00 (685.8)	14.25 (361.9)	3.75 (95.3)	#6–300 MCM	<b>3CBL118</b>
125	30	60	Flush/surface	34.13 (866.8)	14.25 (361.9)	3.75 (95.3)	#6–300 MCM	<b>3CBL130</b>
125	42	84	Flush/surface	39.00 (990.6)	14.25 (361.9)	3.75 (95.3)	#6–300 MCM	<b>3CBL142</b>
225	18	36	Flush/surface	27.00 (685.8)	14.25 (361.9)	3.75 (95.3)	#6–300 MCM	<b>3CBL218</b>
225	30	60	Flush/surface	34.13 (866.8)	14.25 (361.9)	3.75 (95.3)	#6–300 MCM	<b>3CBL230</b>
225	42	84	Flush/surface	39.00 (990.6)	14.25 (361.9)	3.75 (95.3)	#6–300 MCM	<b>3CBL242</b>

**Non-combination (main lug only) single- and three-phase copper bus**

## Single-phase 120/240 Vac Type 1 (indoor) loadcentres

- CSA certified only (not UL approved)
- Utilize Type BAB, QBHW, QBA, DNBA, or QBGF circuit breakers as branch circuit breakers

**Table 45. Single-phase, three-wire 120/240 Vac copper bus loadcentres**

Maximum ampere rating	Max. no. 1-inch spaces	Max. no. 1/2-inches spaces	Cover style	Dimensions in inches (mm)			Wire size range for main Cu/Al	Catalogue number
				H	W	D		
125	18	36	Flush/surface	27.00 (685.8)	14.25 (361.9)	3.75 (95.3)	#6–300 MCM	<b>CBL118CU</b>
125	30	60	Flush/surface	34.13 (866.8)	14.25 (361.9)	3.75 (95.3)	#6–300 MCM	<b>CBL130CU</b>
125	42	84	Flush/surface	39.00 (990.6)	14.25 (361.9)	3.75 (95.3)	#6–300 MCM	<b>CBL142CU</b>
225	18	36	Flush/surface	27.00 (685.8)	14.25 (361.9)	3.75 (95.3)	#6–300 MCM	<b>CBL218CU</b>
225	30	60	Flush/surface	34.13 (866.8)	14.25 (361.9)	3.75 (95.3)	#6–300 MCM	<b>CBL230CU</b>
225	42	84	Flush/surface	39.00 (990.6)	14.25 (361.9)	3.75 (95.3)	#6–300 MCM	<b>CBL242CU</b>

## Three-phase 240 Vac Type 1 (indoor) loadcentres

- CSA certified only (not UL approved)
- Utilize Type BAB, QBHW, QBA, DNBA, or QBGF circuit breakers as branch circuit breakers

**Table 46. Three-phase, four-wire 240 Vac copper bus loadcentres**

Maximum ampere rating	Max. no. 1-inch spaces	Max. no. 1/2-inches spaces	Cover style	Dimensions in inches (mm)			Wire size range for main Cu/Al	Catalogue number
				H	W	D		
125	18	36	Flush/surface	27.00 (685.8)	14.25 (361.9)	3.75 (95.3)	#6–300 MCM	<b>3CBL118CU</b>
125	30	60	Flush/surface	34.13 (866.8)	14.25 (361.9)	3.75 (95.3)	#6–300 MCM	<b>3CBL130CU</b>
125	42	84	Flush/surface	39.00 (990.6)	14.25 (361.9)	3.75 (95.3)	#6–300 MCM	<b>3CBL142CU</b>
225	30	60	Flush/surface	34.13 (866.8)	14.25 (361.9)	3.75 (95.3)	#6–300 MCM	<b>3CBL230CU</b>
225	42	84	Flush/surface	39.00 (990.6)	14.25 (361.9)	3.75 (95.3)	#6–300 MCM	<b>3CBL242CU</b>



## Bolt-on circuit breakers for CBM/CBL

### Type BAB and QBHW single- and multi-pole

Type BAB and QBHW

- 10,000/22,000 A interrupting capacity at 120 Vac, 120/240 Vac, and 240 Vac

Product selection

**Table 47. Single- and multi-pole bolt-on circuit breakers**

Ampere rating	Wire size range (Cu/Al 60 °C or 75 °C) (AWG)	Catalogue number					
		Single-pole, 120/240 Vac		Two-pole, 120/240 Vac		Three-pole, 120/240 Vac	
		10 kAIC	22 kAIC	10 kAIC	22 kAIC	10 kAIC	22 kAIC
10	#14-4	BAB1010	—	—	—	—	—
15	#14-4	BAB1015	QBHW1015	BAB2015	QBHW2015	BAB3015H	QBHW3015
20	#14-4	BAB1020	QBHW1020	BAB2020	QBHW2020	BAB3020H	QBHW3020
25	#14-4	BAB1025	—	—	—	—	—
30	#14-4	BAB1030	QBHW1030	BAB2030	QBHW2030	BAB3030H	QBHW3030
40	#14-4	BAB1040	QBHW1040	BAB2040	QBHW2040	BAB3040H	QBHW3040
50	#14-4	BAB1050	QBHW1050	BAB2050	QBHW2050	BAB3050H	QBHW3050
60	#8-1 Cu, #8-1/0 Al	BAB1060	QBHW1060	BAB2060	QBHW2060	BAB3060H	QBHW3060
70	#8-1 Cu, #8-1/0 Al	BAB1070	QBHW1070	BAB2070	QBHW2070	BAB3070H	QBHW3070
90	#8-1 Cu, #8-1/0 Al	—	—	BAB2090	QBHW2090	BAB3090H	QBHW3090
100	#8-1 Cu, #8-1/0 Al	—	—	BAB2100	QBHW2100	BAB3100H	QBHW3100
125	#8-1 Cu, #8-1/0 Al	—	—	BAB2125	QBHW2125	—	—
			Requires one 1-inch (25.4 mm) space		Requires two 1-inch (25.4 mm) spaces		Requires three 1-inch (25.4 mm) spaces

Type BAB high intensity discharge (HID) rated

- 10,000 A interrupting capacity at 120 Vac, 120/240 Vac, and 240 Vac

**Table 48. Single-pole HID rated bolt-on circuit breakers**

Ampere rating	Wire size range (Cu/Al 60 °C or 75 °C) (AWG)	Catalogue number
		Single-pole, 120/240 Vac 10 kAIC
15	#14-4	BAB1015D
20	#14-4	BAB1020D
Requires one 1-inch (25.4 mm) space		

**Table 49. Single-pole bolt-on fire alarm breakers**

Ampere rating	Configuration	Catalogue number
		Single-pole, 120/240 Vac 10 per shelf carton 10 kAIC
15	Branch fire alarm	BABF1015
20	Branch fire alarm	BABF1020
Compact body breaker		Requires one 1-inch (25.4 mm) space

**Type QBA arc fault circuit interrupter and DNBA duplex**

Type QBA Arc fault circuit interrupter circuit breakers

- 10,000/22,000 A interrupting capacity at 120 Vac 120/240 Vac, and 240 Vac

**Table 50. Single- and two-pole bolt-on FIRE-GUARD AFCI circuit breakers**

Ampere rating	Configuration	Catalogue number				Wire size range (Cu/Al 60 °C or 75 °C) (AWG)
		Single-pole 120/240 Vac		Two-pole, 120/240 Vac <sup>ab</sup>		
		10 kAIC	22 kAIC	10 kAIC	22 kAIC	
15	Standard	<b>QBAF1015</b>	<b>QBHAF1015</b>	—	—	#14–4
15	Combination	<b>QBCAF1015</b>	<b>QBHCAF1015</b>	—	—	#14–4
15	Dual With GFCI 5mA	<b>QB1015AFGF</b>	<b>QBH1015AFGF</b>	—	—	#14–4
15	Common trip	—	—	<b>QBAF2015</b>	<b>QBHAF2015</b>	#14–4
15	Independent trip	—	—	<b>QBAF2015IT</b>	<b>QBHAF2015IT</b>	#14–4
20	Standard	<b>QBAF1020</b>	<b>QBHAF1020</b>	—	—	#14–4
20	Combination	<b>QBCAF1020</b>	<b>QBHCAF1020</b>	—	—	#14–4
20	Dual With GFCI 5mA	<b>QB1020AFGF</b>	<b>QBH1020AFGF</b>	—	—	#14–4
		Requires one 1-inch (25.4 mm) space	Requires one 1-inch (25.4 mm) space	Requires two 1-inch (25.4 mm) spaces	Requires two 1-inch (25.4 mm) spaces	

a Common trip refers to two-pole 240 V load application sourced by 120/240 Vac (see **Figure 25**).

b Independent trip refers to two-pole multi-wire, home run or shared neutral circuits (see **Figure 24** and **Figure 26**).

Type DNBA duplex circuit breakers

- 10,000 A interrupting capacity at 120/240 Vac
- Provides 2 single-pole circuits in one 1-inch space

**Table 51. Twin plug-in circuit breakers**

Ampere rating	Wire size range (Cu/Al 60 °C or 75 °C) (AWG)	Catalogue number
		Single-pole, 120/240 Vac 10 per shelf carton
15–15	#14–4	<b>DNBA1515</b>
20–20	#14–4	<b>DNBA2020</b>
30–30	#14–4	<b>DNBA3030</b>
Requires one 1-inch (25.4 mm) space		

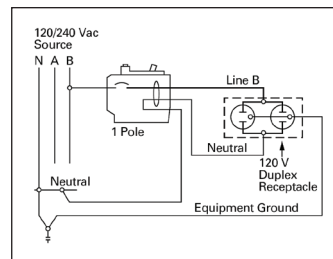

**Figure 23. Single-pole, single 120 V load application sourced by 120/240 Vac**

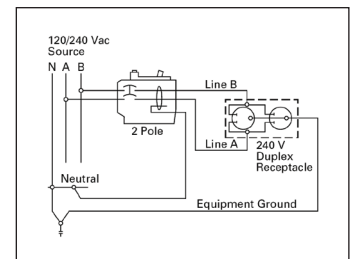

**Figure 25. Two-pole, 240 V load application sourced by 120/240 Vac**

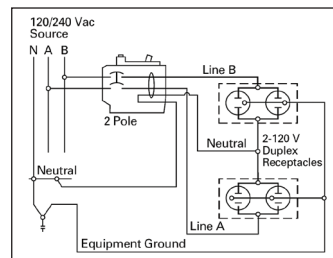

**Figure 24. Two-pole, shared neutral with multi-duplex receptacle application**

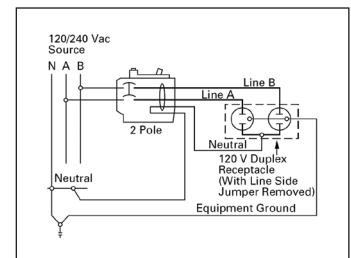

**Figure 26. Two-pole, shared neutral with duplex receptacle application**

**Type QBGF and QBGFEP ground fault**

## Type QBGF and QBGFEP ground fault circuit breakers

- 10,000/22,000 A interrupting capacity at 120 Vac and 120/240 Vac
- 5 mA “people protection” or 30 mA equipment protectors
- Two-pole version features common trip

**Table 52. 5 mA single- and two-pole bolt-on ground fault circuit breakers**

Ampere rating	Wire size range Cu/Al 60 °C or 75 °C (AWG)	Catalogue number	
		Single-pole, 120 Vac 1 per shelf carton 10 kAIC	Two-pole, 120/240 Vac 1 per shelf carton 10 kAIC
15	#14–10 Cu, #12–10 Al	<b>QBGFT1015</b>	<b>QBGFT2015</b>
20	#14–10 Cu, #12–10 Al	<b>QBGFT1020</b>	<b>QBGFT2020</b>
30	#10 Cu, #8 Al	<b>QBGFT1030</b>	<b>QBGFT2030</b>
40	#8 Cu, #8–6 Al	<b>QBGFT1040</b>	<b>QBGFT2040</b>
50	#8–6 Cu, #6–4 Al	—	<b>QBGFT2050</b>
		Requires one 1-inch (25.4 mm) space	Requires two 1-inch (25.4 mm) spaces

**Table 53. 30 mA single- and two-pole bolt-on ground fault circuit breaker equipment protectors**

Ampere rating	Wire size range Cu/Al 60 °C or 75 °C (AWG)	Catalogue number			
		Single-pole, 120 Vac 1 per shelf carton 10 kAIC		Two-pole, 120/240 Vac 1 per shelf carton	
		10 kAIC	22 kAIC	10 kAIC	22 kAIC
15	#14–4	<b>QBGFEP1015</b>	<b>QBHGFEP1015</b>	<b>QBGFEP2015</b>	<b>QBHGFEP2015</b>
20	#14–4	<b>QBGFEP1020</b>	<b>QBHGFEP1020</b>	<b>QBGFEP2020</b>	<b>QBHGFEP2020</b>
25	#14–4	<b>QBGFEP1025</b>	<b>QBHGFEP1025</b>	<b>QBGFEP2025</b>	<b>QBHGFEP2025</b>
30	#14–4	<b>QBGFEP1030</b>	<b>QBHGFEP1030</b>	<b>QBGFEP2030</b>	<b>QBHGFEP2030</b>
		Requires one 1-inch (25.4 mm) space	Requires one 1-inch (25.4 mm) space	Requires two 1-inch (25.4 mm) spaces	Requires two 1-inch (25.4 mm) spaces

## Bolt-on loadcentre and circuit breaker accessories

### Bolt-on accessories

**Table 54. Field installation kits and parts for bolt-on loadcentres and circuit breakers**

<b>Description</b>	<b>Ordering quantity</b>	<b>Catalogue number</b>
Handle lockoff single-pole of Type DNBA duplex circuit breakers (package of 10)	1	<b>BRDL1-10</b>
Handle lockoff Type BQL circuit breakers	1	<b>BQL-10</b>
Handle lockoff Type BAB and QBHW circuit breakers	1	<b>QL123PL</b>
Handle lockdog single-pole Type BAB and QBHW circuit breakers	1	<b>QL1NPL</b>
Handle lockdog two- and three-pole Type BAB and QBHW circuit breakers	1	<b>QL23NPL</b>
Filler plates 1-inch space (package of 24)	1	<b>BRFP</b>
Subfeed lug 100 A (for main lug panel style)	1	<b>CBSF100</b>
Subfeed lug 225 A (for main lug panel style)	1	<b>CBSF225</b>
Subfeed lug kit 100 A three-phase (for main lug panel style)	1	<b>3CBSF100</b>
Subfeed lug kit 225 A three-phase (for main lug panel style)	1	<b>3CBSF225</b>
Circuit breaker directory card 1–42 (package of 50)	1	<b>DIRCARD42</b>
Circuit breaker directory sleeve (package of 25)	1	<b>DIRSLEEVE</b>
Loadcentre door lock	1	<b>TDL</b>
Isolated ground kit	1	<b>ISGRD</b>

### Definitions

Handle lockoffs: Devices that use a padlock to lock a circuit breaker's handle in either the ON or OFF position.

Handle lockdogs: Devices used to secure a circuit breaker's handle in the ON or OFF position. They are not padlockable devices.

## Manual transfer switches/generator panels

### Product description

A transfer switch panel is a device that is mounted next to or incorporated within the loadcentre (distribution panel) in the home or small business. The transfer switch panel is used in conjunction with an emergency generator (usually supplied by others) and serves the purpose of turning selected circuits on and off during a power outage. The transfer switch panel allows the owner to start up a generator and then restore power to critical circuits when utility power is not available.

The owner designates which circuits are critical such as their refrigerator, furnace, and certain lighting loads. Sometimes called emergency power panels, emergency generator panels, gen. panels, transfer switches or emergency panels; transfer switch panels provide the homeowner or small business owner with a safe and easy way to continue using essential electrical loads when utility power is not available.

### Application description

Transfer switch panels are most often used in residential, agricultural and light commercial applications. Comfort and safety are key concerns of many homeowners who are dependent on an uninterrupted supply of electricity.

The increase in our dependence on power is due in part to the popularity of home business and in-home care. In addition, various rural and urban regions in North America experience periodic power outages due to extreme weather conditions such as ice and snowstorms, heat waves, tornadoes or hurricanes. Regions such as Pacific, Atlantic, and Central are the strongest markets for portable generators and transfer switch panels.

### Features, functions, and benefits

Eaton offers two unique manual transfer switch emergency power solutions.

- Manual transfer switches or a generator sub-panel
- Combination service entrance loadcentre with generator sub-panel

## IMPORTANT

**BEFORE INSTALLATION, CONSULT APPROPRIATE ELECTRICAL CODES. INSTALLATION INFORMATION IS INCLUDED IN THE CARTON.**

### Manual transfer switches/generator panels

- Main utility and emergency (generator) breaker factory installed
- Available in 30 and 60 A design
- Utility breaker and generator breakers are mechanically interlocked to protect equipment and personnel by preventing dangerous dual-source feeding
- Critical loads permanently connected to allow for quick and convenient switching from utility power to stand-by generator power
- Designed for switched neutral applications. Can be reconfigured in field for non-switched neutral applications
- Sturdy and reliable 125 A rated aluminum bus design
- Type BR/DNPL branch breakers sold separately
- Ideal for new and retrofit installations
- EEMAC 1 indoor enclosure design
- Standards and certifications
- CSA approved

### Product specifications

- 10,000 AIC rating
- Switching devices must be circuit breakers
- Transfer switch panel must be supplied with neutral and ground



### Combination service entrance loadcentre generator panel CPM126GEN

- Single enclosure (EEMAC 1) to house both loadcentre and generator breakers
- Factory installed main breakers
- Available in 100 and 200 A designs
- Utility and emergency transfer switch breaker factory installed
- Utility breaker and generator breakers are mechanically interlocked to protect equipment and personnel by preventing dangerous dual-source feeding
- Critical loads permanently connected to allow for quick and convenient switching from utility power to stand-by generator power
- Designed for switched neutral applications. Can be reconfigured in field for non-switched neutral applications
- Type BR/DNPL branch breakers sold separately
- Ideal for new and retrofit installations
- EEMAC 1 indoor enclosure design

### Standards and certifications

- CSA approved

### Product specifications

- 10,000 AIC rating for CPM126GEN
- 25,000 AIC rating for CPM236GEN
- Switching devices must be circuit breakers
- Transfer switch panel must be supplied with neutral and ground

**Product selection**

**Table 55. Manual transfer switches/generator panels**

Bus rating (A)	Generator breaker (A)	Switched neutral	Enclosure rating	Max. total branch circuits (1-inch/½-inch)	Inlet receptacle type	Height branch circuits in inches (mm)	Width in inches (mm)	Depth in inches (mm)	Catalogue number
125	30	Yes	EEMAC 1	6/12	—	16.75 (425.5)	14.38 (365.1)	3.88 (98.4)	<b>CPL112G3</b>
125	60	Yes	EEMAC 1	6/12	—	16.75 (425.5)	14.38 (365.1)	3.88 (98.4)	<b>CPL112G6</b>
125	60	Yes	EEMAC 1	14/28	—	21.00 (533.4)	14.38 (365.1)	3.88 (98.4)	<b>CPL120G6</b>
125	60	Yes	EEMAC 1	24/48	—	29.13 (739.8)	14.38 (365.1)	3.88 (98.4)	<b>CPL130G6</b>

**Table 56. Combination service entrance loadcentre generator panel**

Bus rating (A)	Loadcentre main breaker (A)	Max. total branch circuits (1-inch/½-inch)	Generator breaker (A)	Switched neutral	Max. generator branch circuits	Height in inches (mm)	Width in inches (mm)	Depth in inches (mm)	Catalogue number
125	100	26/52	30	Yes	6/12	39.00 (990.6)	14.38 (365.1)	3.88 (98.4)	<b>CPM126GEN</b>
200	200	36/72	60	Yes	6/12	45.00 (1143.0)	14.38 (365.1)	3.88 (98.4)	<b>CPM236GEN</b>

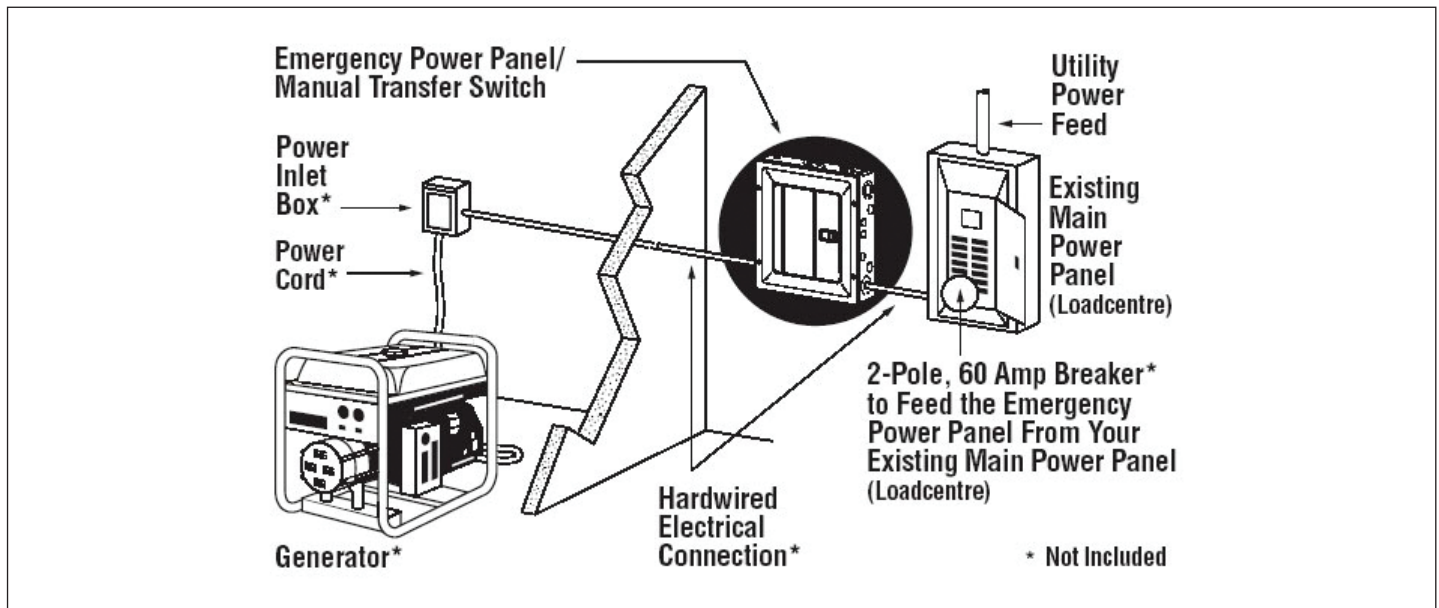

**Figure 27. Typical installation diagram**

**Notes:**

Combination service entrance loadcentre generator panels come complete with an integrated emergency generator panel.

Combination service entrance loadcentre generator panels come complete with factory installed utility feeder breaker for emergency generator panel section.

\* Not Included

## Spa panels

### Single-phase, three-wire 120/240 Vac ground fault circuit interrupter spa panels

- Factory assembled, prewired, tested, and ready to install
- Two-pole 5 mA “people protection” Type CH ground fault circuit interrupter circuit breaker
- Two additional one-pole circuits available
- Test button provides a means of confirming proper GFCI circuit breaker operation
- 10,000 A interrupting capacity
- 120/240 Vac single-phase, three-wire
- Pre-installed neutral and ground bars
- Type 3R enclosure good for indoor or outdoor mounting
- Interior deadfront provides protection from energized parts
- Padlockable cover provides added security and safety
- Audible alarm option field installable
- Can be used as a disconnect to turn the spa pump on and off
- Main lug connections will accommodate a single #14–1/0 AWG conductor <sup>a</sup>

<sup>a</sup> Refer to **page 34** for Type CH ground fault circuit breaker accepted load conductor sizes.



### Product description

CEC Rule 68-086 (1) and (6) requires that a ground fault circuit interrupter, of a Class A Type, be installed not closer than 3 m (10 ft) to a pool or spa water. In cases where a spa is installed some distance from your main loadcentre it is often more convenient to locate this protection device in a small panel closer to the spa. Excessive cable lengths required to connect directly back to a protection device in your main loadcentre may be more susceptible to insulation breakage and result in nuisance tripping of the breaker. The reduced distance the owner must travel to reset a tripped circuit breaker in a localized spa panel may also be an excellent selling point for the owner.

### Product selection

**Table 57. Two-pole plug-in Type 3R spa panels**

Breaker amperage (A)	Breaker type	Enclosure style	Audible alarm	Height in inches (mm)	Width in inches (mm)	Depth in inches (mm)	Catalogue number
30	CH	Indoor/outdoor Type 3R <sup>a</sup>	N	12.00 (304.8)	6.88 (174.6)	4.50 (114.3)	<b>CH30SPAST</b>
40	CH	Indoor/outdoor Type 3R <sup>a</sup>	N	12.00 (304.8)	6.88 (174.6)	4.50 (114.3)	<b>CH40SPAST</b>
50	CH	Indoor/outdoor Type 3R <sup>a</sup>	N	12.00 (304.8)	6.88 (174.6)	4.50 (114.3)	<b>CH50SPAST</b>
60	CH	Indoor/outdoor Type 3R <sup>a</sup>	N	12.00 (304.8)	6.88 (174.6)	4.50 (114.3)	<b>CH60SPAST</b>

<sup>a</sup> Outdoor loadcentres accommodate Type DS conduit hubs. Hubs not included. See **page 15** for selection.

**Table 58. Spa panel accessories**

Description	Catalogue number
Field installable audible alarm kit (breaker and panel not included)	<b>CHSPALARM</b>

**Note:** CEC Rule 68-086 (1) and (6) requires that a ground fault circuit interrupter, of a Class A type, be installed not closer than 3 m (10 ft) to a pool or spa water.

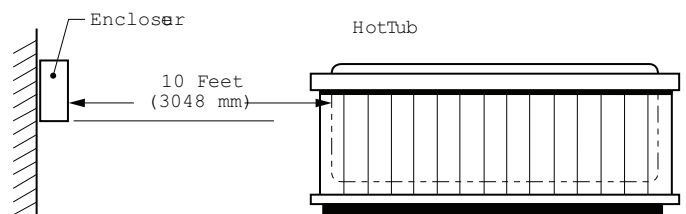

Check national and local codes for compliance.

## Surge suppression products

### Stage 1 and Stage 1 Type 2

#### Residential surge suppression products

- Stage 1 surge protection as well as Type 1 and Type 2 offering
- Convenient in-panel mount unit for Type BR loadcentres
- Knockout mount or surface mount CHSP design. DIN mount adapter for Type 1
- Limited lifetime warranty on CHSPT2ULTRA
- Dovetail clip together cable surge accessories for CHSPT2 design
- Flush mount kit for CHSPT2 design knockout mounting
- Type 2 surge suppression product designed to meet CSA C22.2 No.269-2 and UL 1449 3rd edition standard, cULus Listed No. N 024005



#### Product description

Today's homes are filled with increasing quantities of devices containing sensitive electronic components. These devices can easily be damaged by common power surges also some times called line transients, spikes, or voltage impulses. Lighting strikes, utility grid switching, other users on the powerline, and internal surges from air conditioners and powers tools are the most common sources these damaging line transients. To protect your investment it is recommended that a surge suppression device be installed. Surge protection can be broken into two stages. Stage 1 protection is primary protection for your service entrance. This protection is typically installed inside or adjacent to a home's service entrance distribution panel. Stage 2 protection is secondary protection or protection at the point of use. For proper surge protection both a stage 1 and stage 2 device must be installed. Eaton offers surge products to provide stage 1 protection to your sensitive equipment as well as both Type 1 and Type 2 surge devices that meet the latest CSA C22.2 No. 269 and UL 1449 3rd standard. We also offer surge protection devices for cable/satellite and Ethernet protection since surges are not isolated to the utility lines only.



#### Product selection Combination of Surge Protection and Surge/Breaker Protection

Ideal for applications with limited space in the panel.

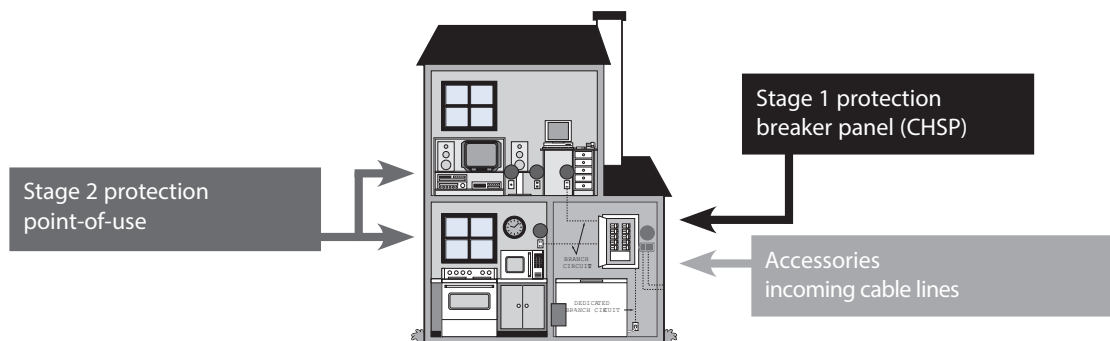

**Table 59. Stage 1 Type 2 (point-of-service entrance) residential surge suppression products for Type BR/CH plug-in loadcentres**

Connection	Voltage (Vac)	Phase	Frequency (Hz)	Maximum continuous operating voltage (V) <sup>a</sup>	Voltage protection rating <sup>b</sup>	Nominal discharge current (A) <sup>c</sup>	Short circuit current rating (A) <sup>d</sup>	Surge current capacity per phase (A) <sup>e</sup>	Catalogue number
Plug-on to loadcentre bus in Type BR loadcentres	120/240	Single	50/60	200 Line-to-Neutral (L-N) 400 Line-to-Line (L-L)	600 V L-N 1000 V L-L	3000	10,000	18,000	<b>BRSURGE</b> Surge only
Plug-on to loadcentre bus in Type BR loadcentres	120/240	Single	50/60	150 Line-to-Neutral (L-N) 300 Line-to-Line (L-L)	600 V L-N 1000 V L-L	10,000	10,000	36,000	<b>BR250SUR</b> Surge and Breaker
Plug-on to loadcentre bus in Type BR loadcentres	120/240	Single	50/60	150 Line-to-Neutral (L-N) 300 Line-to-Line (L-L)	600 V L-N 1000 V L-L	10,000	10,000	36,000	<b>BR250SUR</b> Surge and Breaker
Plug-on to loadcentre bus in Type CH loadcentres	120/240	Single	50/60	150 Line-to-Neutral (L-N) 300 Line-to-Line (L-L)	600 V L-N 1000 V L-L	10,000	10,000	36,000	<b>CH230SUR</b> Surge and Breaker
Plug-on to loadcentre bus in Type CH loadcentres	120/240	Single	50/60	150 Line-to-Neutral (L-N) 300 Line-to-Line (L-L)	600 V L-N 1000V L-L	10,000	10,000	36,000	<b>CH250SUR</b> Surge and breaker

<sup>a</sup> Maximum continuous operating voltage that may be applied to the device per mode.

<sup>b</sup> Voltage protection rating is the measured limiting voltage after a surge event.

<sup>c</sup> Nominal discharge current is the current that the device can withstand for 15 impulses.

<sup>d</sup> The amount of current the product can withstand under short circuit conditions.

<sup>e</sup> The maximum one time surge current rating per phase.



**Table 60. Stage 1 Type 2 (point-of-service entrance) residential surge suppression products for any loadcentre**

Connection	Voltage (Vac)	Phase	Frequency (Hz)	Maximum continuous operating voltage (V) <sup>a</sup>	Voltage protection rating <sup>b</sup>	Nominal discharge current (A) <sup>c</sup>	Short circuit current rating (A) <sup>d</sup>	Surge current capacity per phase (A) <sup>e</sup>	Catalogue number
Can be attached to the outside of any manufacturer's loadcentre (breaker box). This product should be connected on the load side of the loadcentre main service disconnect through a dedicated circuit breaker (follow CEC guidelines).	120/240	Single	60	150 Line-to-Neutral (L-N)	600 V L-N	5,000	22,000	36,000	<b>CHSPT2SURGE</b>
	120/240	Single	60	300 Line-to-Line (L-L)	1000 V L-L	20,000 <sup>f</sup>	22,000	108,000	<b>CHSPT2ULTRA</b>
	120/240	Single	60		800 V N-G	20,000 <sup>f</sup>	22,000	108,000	<b>CHSPT22PACK</b>

- a Maximum continuous operating voltage that may be applied to the device per mode.
- b Voltage protection rating is the measured limiting voltage after a surge event.
- c Nominal discharge current is the current that the device can withstand for 15 impulses.
- d The amount of current the product can withstand under short circuit conditions.
- e The maximum one time surge current rating per phase.
- f When used with a 50 A two-pole breaker, 10 kA when used with a 15 A two-pole breaker.
- g CHSPT22PACK contains one each of CHSPT2ULTRA, CHSPCABLE.

**Accessories**



CHSPCABLE

**Table 61. Residential surge suppression accessories**

Description	Application	Product warranty	Connected equipment warranty	Maximum surge current (A) <sup>a</sup>	Catalogue number
SurgeCable™	Cable TV, satellite, cable modems (2 lines)	Lifetime	\$10,000	20,000	<b>CHSPCABLE</b>
Flushmount Kit™	Flush mount kit for finished wall installations	—	N/A	N/A	<b>CHSPFMKIT</b>

<sup>a</sup> Maximum surge rating is the sum of all modes of protection.

**Installation**

CHSP and accessories can be mounted on the side, top, or bottom of a circuit breaker panel.

**Note:** CHSP SURGE, ULTRA or the 2-pack can be used interchangeably depending on protection required.

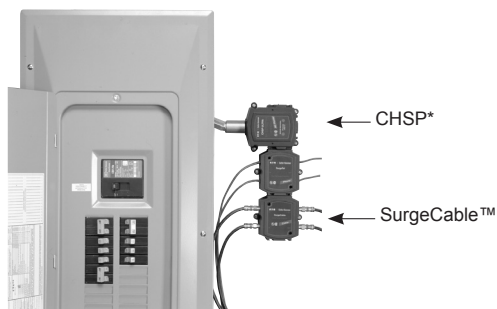

## Street lighting panels

### In-pole



### Service entrance approved street and roadway lighting panels

- Compact in-pole panel fits into lighting pole hand well
- Pole mount 3R (rain-tight) street lighting panels can be mounted right onto the pole
- Pedestal mount 3R (rain-tight) street lighting panels feature a Eaton loadcentre housed in a Pencil enclosure

### Product description

Since January 1, 2003 the Ontario Electric Safety Code requires that all roadway lighting shall meet the service entrance requirements of Rule 30-1002. Eaton has developed several designs of approved products to suit the various installation points (pole mounted, within an enclosure etc.). All products are CSA approved.

### In-pole street lighting panels

- Fits into most pole manufacturers' hand well
- Service entrance approved
- 3R rain-tight
- Pre-wired
- Single- or two-pole, 22 kA, 50 A versions
- Removable mounting plates accommodate multiple hand wells
- CSA approved
- Approximate dimensions 9 x 2.25 x 4 inches
- Line power connections via #6 AWG conductor pigtail
- Load power connections via #14 AWG conductor pigtail
- #6 AWG conductor pigtail provided for daisy chaining of additional light poles

### Product selection

**Table 62. In-pole street lighting panels**

Description	Voltage (Vac)	Main circuit breaker	Interrupting (kAIC)	Catalogue number
120 Vac in-pole compact street lighting panel	120	Single-pole 15 A	22	<b>1SL150PCO</b>
120 Vac in-pole compact street lightning panel	120	Single-pole 30 A	22	<b>1SL300PCO</b>
120 Vac in-pole compact street lighting panel	120	Single-pole 50 A	22	<b>1SL500PCO</b>
240 Vac in-pole compact street lighting panel	120/240	Two-pole 15 A	22	<b>2SL150PCO</b>
240 Vac in-pole compact street lighting panel	120/240	Two-pole 30 A	22	<b>2SL300PCO</b>
240 Vac in-pole compact street lighting panel	120/240	Two-pole 50 A	22	<b>2SL500PCO</b>

**On-pole****On-pole street lighting panels**

- Mounts directly onto the pole
- Strap mount version includes slots in the enclosure back to allow for strap mounting
- Two extra 1-inch breaker locations that accept Type BR and DNPL plug-in circuit breakers for additional lighting loads
- Service entrance approved
- 3R rain-tight
- Single- or two-pole, 22 kA, 50, 60, or 70 A versions
- CSA approved
- Approximate dimensions 13 x 11 x 4.50 inches
- Bottom entry service entrance cabling only

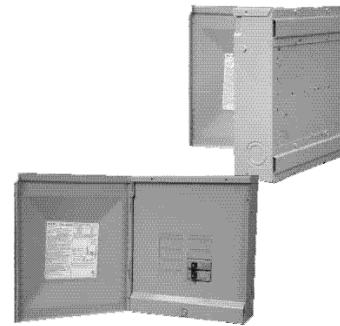
**Product selection****Table 63. On-pole street lighting panels standard mount**

<b>Voltage (Vac)</b>	<b>Main circuit breaker</b>	<b>Interrupting (kAIC)</b>	<b>Branch circuits (1-inch/½-inch)</b>	<b>Main circuit breaker wire size range (Cu/Al 60 °C or 75 °C) (AWG)</b>	<b>Catalogue number</b>
120	Single-pole 50 A	22	2/4	#14-4	<b>1SL502</b>
120	Single-pole 60 A	22	2/4	#4-1/0	<b>1SL602</b>
120	Single-pole 70 A	22	2/4	#4-1/0	<b>1SL702</b>
120/240	Two-pole 50 A	22	2/4	#14-4	<b>2SL502</b>
120/240	Two-pole 60 A	22	2/4	#4-1/0	<b>2SL602</b>
120/240	Two-pole 70 A	22	2/4	#4-1/0	<b>2SL702</b>

**Table 64. On-pole street lighting panels strap mount**

<b>Voltage (Vac)</b>	<b>Main circuit breaker</b>	<b>Interrupting (kAIC)</b>	<b>Branch circuits (1-inch/½-inch)</b>	<b>Main circuit breaker wire size range (Cu/Al 60 °C or 75 °C) (AWG)</b>	<b>Catalogue number</b>
120	Single-pole 50 A	22	2/4	#14-4	<b>1SL502S</b>
120	Single-pole 60 A	22	2/4	#4-1/0	<b>1SL602S</b>
120	Single-pole 70 A	22	2/4	#4-1/0	<b>1SL702S</b>
120/240	Two-pole 50 A	22	2/4	#14-4	<b>2SL502S</b>
120/240	Two-pole 60 A	22	2/4	#4-1/0	<b>2SL602S</b>
120/240	Two-pole 70 A	22	2/4	#4-1/0	<b>2SL702S</b>
120/240	Two-pole 70 A	22	6/12	#4-1/0	<b>2SL706S</b>

**Pedestal**

**Pedestal mounted street lighting panels**

- Lightweight, stand-alone units mount on the ground
- Polyethylene Pencil enclosure provides rugged, low profile, rain-tight assembly
- Penta head and key lock provision for security
- Vented or non-vented enclosure styles
- Two extra 1-inch breaker locations accept Type BR and DNPL plug-in circuit breakers for additional lighting loads
- Service entrance approved
- 3R rain-tight
- Single- or two-pole 22 kA, 50, 60, or 70 A versions
- CSA approved
- Underground duct or direct burial cable accessible



**Product selection**

**Table 65. Pedestal mount non-vented street lighting panels**

Voltage (Vac)	Main circuit breaker	Interrupting (kAIC)	Branch circuits (1-inch/½-inch)	Extension	Main circuit breaker wire size range (Cu/Al 60 °C or 75 °C) (AWG)	Catalogue number
120	Single-pole 50 A	22	2/4	No	#14-4	1SL502NV
120	Single-pole 60 A	22	2/4	No	#4-1/0	1SL602NV
120	Single-pole 70 A	22	2/4	No	#4-1/0	1SL702NV
120/240	Two-pole 50 A	22	2/4	No	#14-4	2SL502NV
120/240	Two-pole 60 A	22	2/4	No	#4-1/0	2SL602NV
120/240	Two-pole 70 A	22	2/4	No	#4-1/0	2SL702NV
120	Single-pole 50 A	22	2/4	Yes	#14-4	1SL502NVE
120	Single-pole 60 A	22	2/4	Yes	#4-1/0	1SL602NVE
120	Single-pole 70 A	22	2/4	Yes	#4-1/0	1SL702NVE
120/240	Two-pole 50 A	22	2/4	Yes	#14-4	2SL502NVE
120/240	Two-pole 60 A	22	2/4	Yes	#4-1/0	2SL602NVE
120/240	Two-pole 70 A	22	2/4	Yes	#4-1/0	2SL702NVE

**Table 66. Pedestal mount vented street lighting panels**

Voltage (Vac)	Main circuit breaker	Interrupting (kAIC)	Branch circuits (1-inch/½-inch)	Extension	Main circuit breaker wire size range (Cu/Al 60 °C or 75 °C) (AWG)	Catalogue number
120	Single-pole 50 A	22	2/4	Yes	#14-4	1SL502VE
120	Single-pole 60 A	22	2/4	Yes	#4-1/0	1SL602VE
120	Single-pole 70 A	22	2/4	Yes	#4-1/0	1SL702VE
120/240	Two-pole 50 A	22	2/4	Yes	#14-4	2SL502VE
120/240	Two-pole 60 A	22	2/4	Yes	#4-1/0	2SL602VE
120/240	Two-pole 70 A	22	2/4	Yes	#4-1/0	2SL702VE

## Combined loadcentre and meter socket

### Combined loadcentre and meter socket

- 4 Jaw, 100 and 200 A, 120/240 V, 22 kAIC
- Service entrance rated with 100 or 200 A main circuit breaker included
- Suitable for underground or overhead service entrance
- Meter socket mechanical lugs accommodate #6–250 MCM Cu/Al line conductors and (2) #6–300 MCM Cu/Al neutral conductors
- Loadcentre mechanical lugs load and neutral (2) #6–300 MCM Cu/Al
- CSR circuit breaker mechanical load lugs #2–300 MCM
- Suitable for overhead or underground service entrance
- Suitable applications include farming, temporary service, construction sites, trailers, and mobile homes
- Hub opening and plate included. Hubs ordered separately (use DS type hubs)
- 3R enclosure
- CSA approved



### Product selection

**Table 67. Combined loadcentre and meter socket**

Enclosure	Voltage (V)	Amperage (A)	Interrupting (kAIC)	Entrance type	Branch circuits (1-inch/½-inch)	Weight in lb (kg)	Dimensions in inches (mm)	Catalogue number
Indoor/outdoor Type 3R	120/240	100	22	Underground/overhead	8/16	36.5 (16.6)	28.38 x 14.44 x 5.38 (974.7 x 366.7 x 136.5)	<b>RCPM108M</b>
Indoor/outdoor Type 3R	120/240	200	22	Underground/overhead	8/16	36.5 (16.6)	28.38 x 14.44 x 5.38 (974.7 x 366.7 x 136.5)	<b>RCPM208M</b>

**Table 68. Knockout legend**

Location	Knockout size in inches (mm)	Quantity
Bottom end wall	0.50 (12.7)	7
Bottom end wall	0.50, 0.75 (12.7, 19.1)	4
Bottom end wall	0.50, 0.75, 1.00 (12.7, 19.1, 25.4)	1
Bottom end wall	1.00, 1.25, 1.50, 2.00 (25.4, 31.8, 38.1, 50.8)	1
Bottom end wall	1.25, 1.50, 2.00, 2.50, 3.00 (31.8, 38.1, 50.8, 63.5, 76.2)	1
Top end wall	Provision for Hub <sup>a</sup> (e.g. DS200H2, DS250H2, DS300H2)	2
Backplane	1.25, 1.50, 2.00, 2.50 (31.8, 38.1, 50.8, 63.5)	1
Backplane	1.25, 1.50, 2.00 (31.8, 38.1, 50.8)	1
Right sidewall	1.25, 1.50, 2.00, 2.50 (31.8, 38.1, 50.8, 63.5)	1

<sup>a</sup> Accommodate Type DS conduit hubs. Hubs not included. See **page 15** for selection.

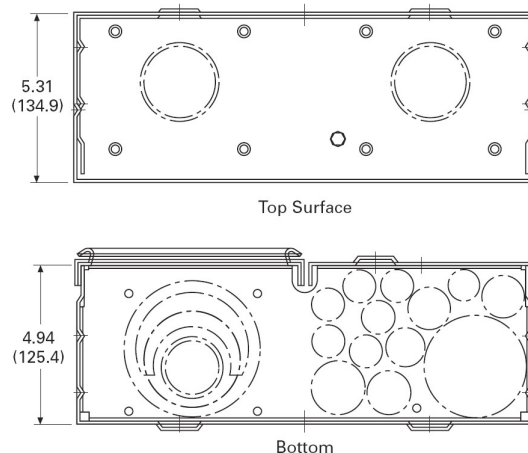

## Metered temporary ground fault power panel

### Metered temporary power panel with ground fault protection

- Combination loadcentre, meter socket, and electrical outlets for temporary work site installations
- Single-phase, three-wire
- 4 jaw, 100 or 200 A, 120/240 V, 22 kAIC meter socket
- Suitable for overhead or underground service entrance
- CSA approved for service entrance
- 3R enclosure suitable for outdoor installations
- Two different receptacle combinations 6X20A and 2X30A or 10X20A
- Hub opening and plate included. Hubs ordered separately (uses DS type hubs)
- Meter socket mechanical lugs accommodate #6–250 MCM Cu/Al line conductors and #6–300 MCM Cu/Al neutral conductors



### Product selection

**Table 69. Metered temporary ground fault protected power panel**

Enclosure	Voltage (V)	Amperage (A)	Interrupting (kAIC)	Entrance Type	20 A receptacles	30 A receptacles	Dimensions in inches (mm)	Catalogue number
Indoor/outdoor Type 3R	120/240	100	22	Underground/overhead	6	2	34.38 x 22.00 x 5.38 (873.1 x 558.8 x 136.5)	<b>RCPM1GF6H</b>
Indoor/outdoor Type 3R	120/240	100	22	Underground/overhead	10	0	34.38 x 22.00 x 5.38 (873.1 x 558.8 x 136.5)	<b>RCPM1GF10</b>
Indoor/outdoor Type 3R	120/240	200	22	Underground/overhead	6	2	34.38 x 22.00 x 5.38 (873.1 x 558.8 x 136.5)	<b>RCPM2GF6H</b>
Indoor/outdoor Type 3R	120/240	200	22	Underground/overhead	10	0	34.38 x 22.00 x 5.38 (873.1 x 558.8 x 136.5)	<b>RCPM2GF10</b>

**Table 70. Knockout legend**

Catalogue number	Knockout size (inches)	Quantity
Bottom endwall	0.50, 0.75	6
Bottom endwall	0.50, 0.75, 1.00, 1.25	2
Bottom endwall	1.00, 1.25, 1.50, 2.00, 2.50	1
Bottom endwall	1.00, 1.25, 1.50, 2.00, 2.50, 3.00	1
Top endwall	Provision for Hub <sup>a</sup> (e.g. DS200H2, DS250H2, DS300H2)	1

<sup>a</sup> Accommodate Type DS conduit hubs. Hubs not included. See **page 15** for selection.



Top Surface

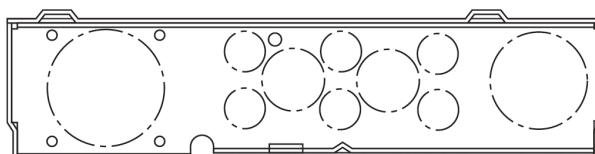

Bottom

### Mini-power centres



#### Mini-power centres

- Distribution transformer, breaker protection, and loadcentre all in one compact package
- Primary and secondary breaker protection via factory installed EHD or FDB type MCCBs
- 18, 25, or 35 kAIC interrupting capacity versions available on select models through special order
- Two styles of interior; one for plug-in or bolt-on (breakers not included)
- Loadcentre accommodates up to 24 feeder circuit breakers (breakers purchased separately)
- Aluminum chassis on plug-in type, copper chassis on bolt-on type, standard ground bar, and enclosure grounded neutral bar
- All live parts are enclosed
- Hinged, padlockable cover prevents removal
- Enclosure includes grounding terminal
- Type 3R enclosure with baked polymer polyester powder coating is good for indoor or outdoor mounting
- Optional Type 3R, 316 grade stainless steel enclosure
- Main circuit breaker barrier provides CSA approval for service entrance applications
- Electrical grade aluminum windings standard on the distribution transformer (copper optional)
- Copper windings standard on bolt-on style units
- 185 °C insulation system
- 115 °C winding temperature rise
- Full capacity taps (FCBN) 2–5%
- Resin encapsulated, core-coil assembly (cores grounded with copper lead)

### Product description

Contemporary electrical distribution systems are required to do more in less space while at the same time being cost-effective. Eaton provides a solution to these requirements with the proven mini-power centre. It occupies considerably less space and can save up to 31 percent of the installation costs normally required when individual components are used. The solution is possible because a mini-power centre combines three individual components into one NEMA Type 3R enclosure: a main breaker, an encapsulated Type EP or EPT dry-type transformer, and a secondary distribution loadcentre with main breaker. Interconnecting wiring is completed at the factory. A mini-power centre is delivered ready for installation. It's suitable for use as service entrance equipment, too. Mini-power centres are used wherever there is a 480 V or 600 V distribution system and loads requiring 208Y/120 V three-phase or 120/240 V single-phase.

Typical installations include:

- Industrial plant assembly lines
- Plant expansions
- Commercial buildings
- Test equipment
- Temporary power at construction sites
- Sewage disposal plants
- Warehouses
- Car washes
- Parking lots

The mini-power centre saves you space, time, and money. A mini-power centre installation takes up only 42% of the space taken up by a typical installation. A typical installation being comprised of a separately mounted distribution transformer, disconnect switch, loadcentre and all associated wiring and connectors.

The installation costs of a mini-power centre are 31% less when compared with the same typical installation.

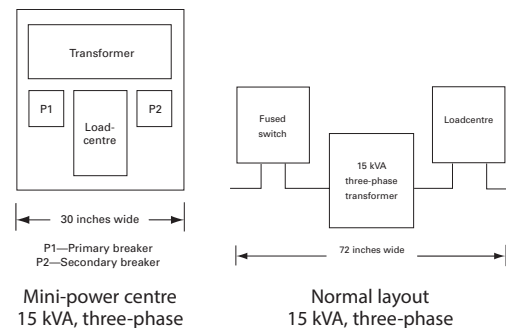

Installation	Time to perform task(s) a (hours)			
	Typical installation 15 kVA	Mini-power centre installation 15 kVA	Typical installation 25 kVA	Mini-power centre installation 25 kVA
Switch and fuse mounting	5	0	5	0
Transformer layout (remove knockout, etc.)	16	16	24	24
Fasten transformer to wall	4	0	4	0
Layout loadcentre, mount and connect source	4	4	6	4
Total hours	29	20	39	28
% time saved by using a eaton mini-power centre		31%		28%



## Plug-in mini-power centres

### Plug-in

**Table 71. Single-phase plug-in mini-power centres**

kVA	Primary and secondary voltage (V)	Catalogue number <sup>a</sup>	Main circuit breaker <sup>b</sup>		Maximum number of feeder circuit breakers			Maximum amperage	Dimensions in inches (mm) <sup>c</sup>			Weight in lb (kg)
			Primary	Secondary	Single-pole	Two-pole	Three-pole		Height	Width	Depth	
3	480 to 120/240	<b>P48G11S03P</b>	EHD2015	BR215	8	4	—	12	27.05 (699.0)	12.60 (320.0)	9.70 (245.0)	105 (47)
5	480 to 120/240	<b>P48G11S05P</b>	EHD2020	BR225	12	6	—	20	29.50 (749.0)	12.60 (320.0)	9.70 (245.0)	105 (47)
7.5	480 to 120/240	<b>P48G11S07P</b>	EHD2030	BR230	12	6	—	30	29.50 (749.0)	12.60 (320.0)	9.70 (245.0)	125 (56)
10	480 to 120/240	<b>P48G11S10P</b>	EHD2040	BR250	12	6	—	40	38.20 (970.0)	13.50 (343.0)	11.80 (300.0)	177 (80)
15	480 to 120/240	<b>P48G11S15P</b>	EHD2060	BR270	20	10	—	60	38.20 (970.0)	13.50 (343.0)	11.80 (300.0)	212 (96)
25	480 to 120/240	<b>P48G11S25P</b>	EHD2100	BR2125	26	13	—	100	43.90 (1115.0)	16.40 (417.0)	11.80 (300.0)	373 (169)
5	600 to 120/240	<b>P60G11S05P</b>	FDB2015	BR225	12	6	—	20	29.50 (749.0)	12.60 (320.0)	14.60 (370.0)	105 (47)
7.5	600 to 120/240	<b>P60G11S07P</b>	FDB2030	BR230	12	6	—	30	29.50 (749.0)	12.60 (320.0)	9.70 (245.0)	125 (56)
10	600 to 120/240	<b>P60G11S10P</b>	FDB2040	BR250	12	6	—	40	38.20 (970.0)	13.50 (343.0)	9.70 (245.0)	177 (80)
15	600 to 120/240	<b>P60G11S15P</b>	FDB2060	BR270	20	10	—	60	38.20 (970.0)	13.50 (343.0)	11.80 (300.0)	212 (96)
25	600 to 120/240	<b>P60G11S25P</b>	FDB2100	BR2125	26	13	—	100	43.90 (1115.0)	16.40 (417.0)	14.60 (370.0)	373 (169)

<sup>a</sup> For a primary main circuit breaker interrupting capacity greater than 10 kAIC, add the following suffixes to the catalogue number; for 18 kAIC, add "F"; for 25 kAIC, add "H"; and for 35 kAIC, add "C".

<sup>b</sup> Main circuit breakers fixed only. No substitutes.

<sup>c</sup> Not for construction purposes.

**Note:** For price and delivery on a unit with copper transformer windings or 316 grade stainless steel enclosure, contact your local Eaton sales representative or our Customer Service centre at 1-800-268-3578. Feeder circuit breakers not included. Uses Eaton Type BR circuit breakers.

**Table 72. Three-phase plug-in mini-power centres**

kVA	Primary and secondary voltage (V)	Catalogue number <sup>a</sup>	Main circuit breaker <sup>b</sup>		Maximum number of feeder circuit breakers			Maximum amperage	Dimensions in inches (mm) <sup>c</sup>			Weight in lb (kg)
			Primary	Secondary	Single-pole	Two-pole	Three-pole		Height	Width	Depth	
15	480 to 120/208	<b>P48G28T15P</b>	EHD3040	BR350	18	9	6	40	36.10 (917.0)	28.80 (732.0)	9.70 (245.0)	320 (145)
22.5	480 to 120/208	<b>P48G28T21P</b>	EHD3070	BR370	18	9	6	60	40.90 (1039.0)	29.90 (759.0)	11.80 (300.0)	565 (256)
30	480 to 120/208	<b>P48G28T30P</b>	EHD3090	BR3100	24	12	8	80	41.90 (1064.0)	29.90 (759.0)	13.60 (346.0)	635 (288)
15	600 to 120/208	<b>P60G28T15P</b>	FDB3030	BR350	18	9	6	40	36.10 (917.0)	28.80 (732.0)	9.40 (238.0)	320 (145)
22.5	600 to 120/208	<b>P60G28T21P</b>	FDB3050	BR370	18	9	6	60	40.90 (1039.0)	29.90 (759.0)	5650 (256.0)	565 (256)
30	600 to 120/208	<b>P60G28T30P</b>	FDB3070	BR3100	24	12	8	80	41.90 (1064.0)	29.90 (759.0)	6350 (288.0)	635 (288)

<sup>a</sup> For a primary main circuit breaker interrupting capacity greater than 10 kAIC, add the following suffixes to the catalogue number; for 18 kAIC add "F", for 25 kAIC add "H", and for 35 kAIC add "C".

<sup>b</sup> Main circuit breakers fixed only. No substitutes.

<sup>c</sup> Not for construction purposes.

**Note:** For price and delivery on a unit with copper transformer windings or 316 grade stainless steel enclosure, contact your local Eaton sales representative or our Customer Service centre at 1-800-268-3578. Feeder circuit breakers not included. Uses Eaton Type BR circuit breakers.



## Bolt-on mini-power centres

### Bolt-on

Table 73. Single-phase bolt-on mini-power centres

kVA	Primary and secondary voltage (V)	Catalogue number	Main circuit breaker <sup>a</sup>		Maximum number of feeder circuit breakers <sup>bc</sup>			Maximum amperage	Dimensions in inches (mm) <sup>d</sup>			Weight in lb (kg)
			Primary	Secondary	Single-pole	Two-pole	Three-pole		Height	Width	Depth	
3	480 to 120/240	<b>P48G11S03CUB</b>	EHD2015L	BAB2015	12	6	—	12	33.20 (845.0)	12.60 (320.0)	9.70 (245.0)	105 (47)
5	480 to 120/240	<b>P48G11S05CUB</b>	EHD2020L	BAB2025	18	9	—	20	36.10 (918.0)	12.60 (320.0)	9.70 (245.0)	110 (50)
7.5	480 to 120/240	<b>P48G11S07CUB</b>	EHD2030L	BAB2030	18	9	—	30	36.10 (918.0)	12.60 (320.0)	9.70 (245.0)	110 (50)
10	480 to 120/240	<b>P48G11S10CUB</b>	EHD2040L	BAB2050	18	9	—	40	40.90 (1038.0)	13.50 (343.0)	11.80 (300.0)	180 (82)
15	480 to 120/240	<b>P48G11S15CUB</b>	EHD2060L	BAB2070	24	12	—	60	43.90 (1115.0)	15.00 (380.0)	11.80 (300.0)	215 (98)
25	480 to 120/240	<b>P48G11S25CUB</b>	EHD2100L	BAB2125	30	15	—	100	43.40 (1102.0)	20.40 (518.0)	14.60 (370.0)	385 (175)
3	600 to 120/240	<b>P60G11S03CUB</b>	FDB2015L	BAB2015	12	6	—	12	33.20 (845.0)	12.60 (320.0)	9.70 (245.0)	105 (47)
5	600 to 120/240	<b>P60G11S05CUB</b>	FDB2020L	BAB2025	18	9	—	20	36.10 (918.0)	12.60 (320.0)	9.70 (245.0)	110 (50)
7.5	600 to 120/240	<b>P60G11S07CUB</b>	FDB2030L	BAB2030	18	9	—	30	36.10 (918.0)	12.60 (320.0)	9.70 (245.0)	110 (50)
10	600 to 120/240	<b>P60G11S10CUB</b>	FDB2040L	BAB2050	18	9	—	40	40.90 (1038.0)	13.50 (343.0)	11.80 (300.0)	180 (82)
15	600 to 120/240	<b>P60G11S15CUB</b>	FDB2060L	BAB2070	24	12	—	60	43.90 (1115.0)	15.00 (380.0)	11.80 (300.0)	215 (98)
25	600 to 120/240	<b>P60G11S25CUB</b>	FDB2100L	BAB2125	30	15	—	100	43.40 (1102.0)	20.40 (518.0)	14.60 (370.0)	385 (175)

<sup>a</sup> Main circuit breakers fixed only. No substitutes.

<sup>b</sup> Feeder circuit breakers not included. Uses Eaton Type BAB circuit breakers.

<sup>c</sup> Combinations can be selected.

<sup>d</sup> Not for construction purposes.

Table 74. Three-phase bolt-on mini-power centres

kVA	Primary and secondary voltage (V)	Catalogue number	Main circuit breaker <sup>a</sup>		Maximum number of feeder circuit breakers <sup>bc</sup>			Maximum amperage	Dimensions in inches (mm) <sup>d</sup>			Weight in lb (kg)
			Primary	Secondary	Single-pole	Two-pole	Three-pole		Height	Width	Depth	
15	480 to 120/208	<b>P48G28T15CUB</b>	EHD3040L	BAB3050H	18	9	6	40	36.10 (917.0)	28.70 (730.0)	9.40 (238.0)	320 (148)
22.5	480 to 120/208	<b>P48G28T21CUB</b>	EHD3070L	BAB3070H	18	9	6	60	40.90 (1038.0)	29.90 (759.0)	13.60 (346.0)	565 (257)
30	480 to 120/208	<b>P48G28T30CUB</b>	EHD3090L	BAB3100H	24	12	8	80	41.90 (1063.0)	29.90 (759.0)	13.60 (346.0)	635 (288)
15	600 to 120/208	<b>P60G28T15CUB</b>	FDB3030	BAB3050H	18	9	6	40	36.10 (917.0)	28.70 (730.0)	9.40 (238.0)	320 (148)
22.5	600 to 120/208	<b>P60G28T21CUB</b>	FDB3050	BAB3070H	18	9	6	60	40.90 (1038.0)	29.90 (759.0)	13.60 (346.0)	565 (257)
30	600 to 120/208	<b>P60G28T30CUB</b>	FDB3070	BAB3100H	24	12	8	80	41.90 (1063.0)	29.90 (759.0)	13.60 (346.0)	635 (288)

<sup>a</sup> Main circuit breakers fixed only. No substitutes.

<sup>b</sup> Feeder circuit breakers not included. Uses Eaton Type BAB circuit breakers.

<sup>c</sup> Combinations can be selected.

<sup>d</sup> Not for construction purposes.

## Residential fuse panel inserts

### Residential fuse panel inserts <sup>a</sup>

- Convenient and economical option to completely replacing an entire fuse panel assembly
- Original fuse panel tub and wiring remains in place and only the fuse panel trim and interior is removed and replaced
- 16 and 24 circuit breaker interiors designed to fit any manufacturers' fuse panel or discontinued design circuit breaker panel
- Custom trim and door oversized to ensure fit with existing tub
- Circuit breaker interior replacement eliminates the possibility of improperly sized amperage protection
- No more loose fuses causing arcing and damage to the panel or wiring
- CSA certified to mount into any existing box under file LL264-222
- Can be mounted in any orientation as defined by the existing fuse panel tub orientation
- Accepts plug-in Type BR, DNPL, or GFCB circuit breakers (circuit breakers sold separately, refer to **page 17** to **page 20** for selection)
- Trim comes complete with hinged door, non-locking spring latch, clear plastic card holder, and circuit directory card
- Tin plated aluminum bus bars

<sup>a</sup> Not for use as service entrance equipment.

### Product description

Fuses and fuse panels were designed decades ago, to prevent the overload of circuit wiring that could lead to fires caused by overloaded electrical circuit connections and/or short circuits. Records show however, that problems of fire and smoke inhalation are the more serious causes of death or injury.

Since early 1960's, technology has allowed a tremendous increase in the number and use of appliances, tools, and control systems, many of which are automatically controlled and cycle on and off. We now know that a cycling load will actually cause a plug (screw-on-type) fuse to loosen in its holder (that explains why you can always find one or two fuses that can be tightened a quarter turn). Loose connections such as these develop heat, and in turn increase the risk of fire.

Small overloads can be absorbed by the margin of safety built into CSA certified devices. However, prolonged overloads or loose fuses will cause arcing and ultimately, melting of the connections in either the panel or wiring, wherever the weakest link may be.

Eaton has designed a low cost method of replacing fuse panels with modern circuit breaker panels. This method eliminates the need for cutting, re-plastering and repainting the walls around the old panel.

Another risk with the old fuse panel design was the ease with which incorrect fuses could be used or changed without realization of the risks involved.

To eliminate these potential hazards Eaton has a new circuit breaker interior and trim kit that will quickly upgrade the existing installation to today's electrical standards and needs. An average upgrade takes one hour and thus creates the minimum of inconvenience to the homeowner/occupant.

### Sample specification

- Supply and install a new circuit breaker interior to replace existing plug fuse panel interior or out of date circuit breaker interior in each apartment or condominium
- Interior to be 16 or 24 circuit, rated 100 A and 120/240 V, designed in a single row breaker arrangement for fitting into existing recessed electrical panels
- Supply and install new trim and door assembly slightly larger than discarded fuse trim to minimize any requirements for patching or repainting
- Bus bars shall be tin plated aluminum suitable for plug-in circuit breakers
- Supply and install a trim and door assembly with latch, to protect the circuit breaker toggle handles
- Inserts must be CSA certified for mounting in any position, for ease in connecting to existing wiring
- Install circuit breakers with ratings as indicated in specifications or drawings
- Interiors to be mounted with directions template and hardware supplied by Eaton
- Inserts, trim and door assembly and circuit breakers, shall be manufactured by Eaton
- Provide a circuit identification card, mounted under clear plastic on the inside of the door

**Insert interiors**

**Residential fuse panel insert interiors**

- 100 A single-phase, three-wire 120/240 Vac
- 16 and 24 circuit breaker capacity <sup>a</sup>
- CSA certified to mount into any existing box under file LL264-222
- Accepts plug-in type BR and DNPL circuit breakers <sup>ab</sup>
- Tin plated aluminum bus bars
- Neutral available with 16 or 24 Cu/Al terminals
- Main and neutral lugs located at the same end
- All terminals accept #14–3 AWG cabling

<sup>a</sup> Filler plates for unused fuse panel insert circuit breaker installation locations can be ordered as BRFP (package of 24).

<sup>b</sup> Refer to **page 17** to **page 20** for plug-in circuit breaker selection.

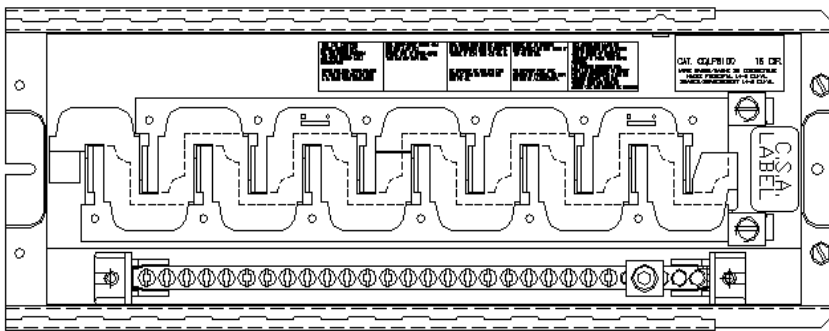

**Table 75. Three-wire 120/240 Vac fuse panel insert interiors**

Amperage rating (A)	Voltage (V)	Number of installable circuit breakers		Bus material	Neutral material	Wire size range Cu/Al	Catalogue number	Drilling template catalogue number <sup>a</sup>
		1-inch spaces	1/2-inch spaces					
100	120/240	8	16	Aluminum	Aluminum	#14–3 AWG	<b>CQLP8100</b>	<b>CSABP4683B</b>
100	120/240	12	24	Aluminum	Aluminum	#14–3 AWG	<b>CQLP12100</b>	<b>CSABP4734B</b>

<sup>a</sup> We suggest the use of templates to ensure proper sizing for installation.

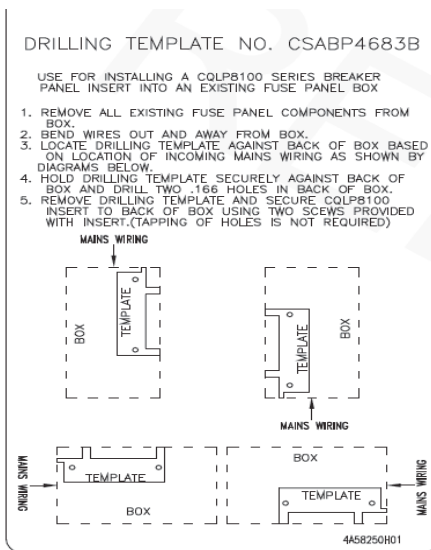

**Trims**

**Residential fuse panel insert trims**

- Doors are die formed with sloping sides and rounded corners and permanently mounted to the trim
- Semi concealed hinges <sup>a</sup>
- Includes circuit directory card and self adhesive clear plastic directory holder
- Painted ASA61 light grey baked on enamel
- Mounting hardware included <sup>b</sup>
- Trims are custom sized larger than the existing trim and door
- Trim mounting holes located to line up with existing box holes <sup>c</sup>

- <sup>a</sup> If the main service entrance is bottom entry, the door hinges left. If it is top entry, then the door hinges right.
- <sup>b</sup> The hardware supplied will accommodate boxes that are mounted up to 1/2-inch too deep or equal to 3-1/2 inches net depth.
- <sup>c</sup> Measure the existing box holes locations as they may be part of the end walls, side walls, or tapped into a box flange.

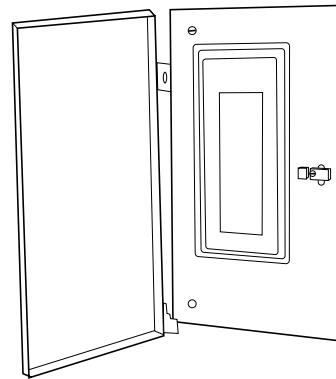

**Table 76. Fuse panel insert trims**

Original manufacturer	Fuse panel catalogue number	Box dimensions (inches)			Replacement trim catalogue number	Trim size (inches)		Replacement interior catalogue number	Trim mounting holes (inches)	
		Height	Width	Depth		Height	Width		Height	Width
Amalgamated	<b>4112</b>	16-1/8	8-1/2	2-15/16	<b>QLPT16D</b>	18-1/4	9-3/4	<b>CQLP8100</b>	16-1/6	4
Amalgamated	<b>4116</b>	19-1/2	8-1/2	2-15/16	<b>QLPT19D</b>	20-7/8	9-3/4	<b>CQLP8100</b>	18-11/16	4
Amalgamated	<b>4120</b>	22-7/8	8-1/2	2-15/16	<b>QLPT22AD</b>	25	10-1/2	<b>CQLP12100</b> <sup>a</sup>	22-1/4	6
Amalgamated	<b>4208</b>	16-1/8	8-1/2	2-15/16	<b>QLPT16AD</b>	18-1/4	10-5/16	<b>CQLP8100</b>	15-1/2	6
Amalgamated	<b>4212</b>	19-1/2	8-1/2	2-15/16	<b>QLPT20AD</b>	20-7/8	9-3/4	<b>CQLP8100</b>	18-11/16	6
Amalgamated	<b>4216</b>	22-7/8	8-1/2	2-15/16	<b>QLPT22AD</b>	25	10-1/2	<b>CQLP12100</b> <sup>a</sup>	22-1/4	6
Amalgamated	<b>4220</b>	24-1/8	8-1/2	2-15/16	<b>QLPT24D</b>	26	9-3/4	<b>CQLP12100</b> <sup>a</sup>	23-13/16	4
Amalgamated	<b>4312</b>	22-7/8	8-1/2	2-15/16	<b>QLPT22AD</b>	25	10-1/2	<b>CQLP12100</b> <sup>a</sup>	22-1/4	6
CEB	<b>NHP10-636-3</b> <sup>b</sup>	24	10	3	<b>QLPT24LD</b>	26	12	<b>CQLP12100</b> <sup>a</sup>	23-13/16	4
CEB	<b>NHP6-60</b> <sup>c</sup>	14	7-3/4	3	<b>QLPT14D</b>	16	9-3/4	<b>CQLP8100</b>	13-3/16	4
CEB	<b>NHP12-60</b>	20	7-3/4	3	<b>QLPT20D</b>	21-3/4	9-3/4	<b>CQLP12100</b> <sup>a</sup>	19-9/16	4
CEB	<b>NHP12-633</b>	23	7-3/4	3	<b>QLPT24D</b>	26	9-3/4	<b>CQLP12100</b> <sup>a</sup>	23-13/16	4
CEB	<b>NHP4-632</b>	16-1/4	7-3/4	3	<b>QLPT16D</b>	18-1/4	9-3/4	<b>CQLP8100</b>	16-1/6	4
CEB	<b>NHP6-633</b>	20	7-3/4	3	<b>QLPT19D</b>	20-7/8	9-3/4	<b>CQLP8100</b>	18-11/16	4
CEB	<b>NHP6-636-4</b>	24	7-3/4	3	<b>QLPT24D</b>	26	9-3/4	<b>CQLP12100</b> <sup>a</sup>	23-13/16	4
CEB	<b>NHP8-60</b>	16-1/8	7-3/4	3	<b>QLPT16D</b>	18-1/4	9-3/4	<b>CQLP8100</b>	16-1/6	4
CEB	<b>NHP8-635-3</b>	23	7-3/4	3	<b>QLPT24D</b>	26	9-3/4	<b>CQLP12100</b> <sup>a</sup>	23-13/16	4
Taylor (Crouse-Hinds)	<b>NHP6-30-60</b>	21	7-3/8	3	<b>QLPT20D</b>	21-3/4	9-3/4	<b>CQLP12100</b> <sup>a</sup>	19-9/16	4
Taylor (Crouse-Hinds)	<b>NHP20-1231</b>	24-1/2	9-1/2	3	<b>QLPT24D</b>	26	9-3/4	<b>CQLP12100</b> <sup>a</sup>	23-13/16	4
Taylor (Crouse-Hinds)	<b>NHP20-0821-6</b>	24-1/2	9-1/2	3	<b>QLPT24D</b>	26	9-3/4	<b>CQLP12100</b> <sup>a</sup>	23-13/16	4
Taylor (Crouse-Hinds)	<b>NHP12B-1000-2</b>	17-1/8	9-1/2	3	<b>QLPT16AD</b>	18-1/8	10-5/16	<b>CQLP8100</b>	15-1/2	6
Taylor (Crouse-Hinds)	<b>NHP10-0401-4</b>	17-1/8	9-1/2	3	<b>QLPT16AD</b>	18-1/8	10-5/16	<b>CQLP8100</b>	15-1/2	6
Taylor (Crouse-Hinds)	<b>NHP10-0601-2</b>	17-1/8	9-1/2	3	<b>QLPT16AD</b>	18-1/8	10-5/16	<b>CQLP8100</b>	15-1/2	6
Taylor (Crouse-Hinds)	<b>NHP10-0611</b>	17-1/8	9-1/2	3	<b>QLPT16AD</b>	18-1/8	10-5/16	<b>CQLP8100</b>	15-1/2	6
Taylor (Crouse-Hinds)	<b>NHP10-0801</b>	17-1/8	9-1/2	3	<b>QLPT16AD</b>	18-1/8	10-5/16	<b>CQLP8100</b>	15-1/2	6
Taylor (Crouse-Hinds)	<b>NHP12-0811</b>	19-1/4	9-1/2	3	<b>QLPT22AD</b>	25	10-1/2	<b>CQLP12100</b> <sup>a</sup>	22-1/4	6
Taylor (Crouse-Hinds)	<b>NHP14-0801-4</b>	19-1/4	9-1/2	3	<b>QLPT22AD</b>	25	10-1/2	<b>CQLP12100</b> <sup>a</sup>	22-1/4	6
Taylor (Crouse-Hinds)	<b>NHP14-0621-2</b>	19-1/4	9-1/2	3	<b>QLPT22AD</b>	25	10-1/2	<b>CQLP12100</b> <sup>a</sup>	22-1/4	6

<sup>a</sup> Panel insert CQLP8100 can also be used with this size trim.

<sup>b</sup> For box sizes either 26 inches or 27-1/2 inches high, no insert or trim is available.

<sup>c</sup> For box size 14" only

## Replacement classic circuit breakers

### Bolt-on Type BQL single-, multi-pole, Duplex, and Quadplex

Type BQL <sup>a</sup>

- 10,000/22,000 A interrupting capacity at 120/240 Vac
- Captive line screw included (#2 Robertson/Slot)

<sup>a</sup> HACR rated.

Product selection

**Table 77. Single- and multi-pole bolt-on classic replacement circuit breakers**

Ampere rating	Wire size range (Cu/Al 60 °C or 75 °C) (AWG)	Catalogue number							
		Single-pole, 120/240 Vac		Two-pole, 120/240 Vac		Three-pole, 120/240 Vac			
		10 kAIC	22 kAIC	10 kAIC	10 kAIC	22 kAIC	22 kAIC		
15	#14–8	<b>BQL15</b> <sup>a</sup>	<b>HBQL15</b>	<b>BQL215</b>		<b>BQL315</b>	<b>HBQL315</b>		
20	#14–8	<b>BQL20</b> <sup>a</sup>	<b>HBQL20</b>	<b>BQL220</b>		<b>BQL320</b>	—		
25	#14–8	<b>BQL25</b>	<b>HBQL25</b>	<b>BQL225</b>		—	—		
30	#14–8	<b>BQL30</b>	<b>HBQL30</b>	<b>BQL230</b>		<b>BQL330</b>	<b>HBQL330</b>		
40	#14–4	<b>BQL40</b>	<b>HBQL40</b>	<b>BQL240</b>		<b>BQL340</b>	—		
50	#14–4	<b>BQL50</b>	<b>HBQL50</b>	<b>BQL250</b>		<b>BQL350</b>	<b>HBQL350</b>		
60	#8–2/0	<b>BQL60</b>	<b>HBQL60</b>	<b>BQL260</b>		<b>BQL360</b>	<b>HBQL360</b>		
70	#8–2/0	—	—	<b>BQL270</b>		<b>BQL370</b>	<b>HBQL370</b>		
90	#8–2/0	—	—	<b>BQL290</b>		<b>BQL390</b>	<b>HBQL390</b>		
100	#8–2/0	—	—	<b>BQL2100</b>		<b>BQL3100</b>	<b>HBQL3100</b>		
125	#8–2/0	—	—	<b>BQL2125</b>		—	—		
135	#8–2/0	—	—	<b>BQL2135</b>		—	—		
				Requires one 1-inch (25.4 mm) space		Requires two 1-inch (25.4 mm) spaces		Requires three 1-inch (25.4 mm) spaces	

<sup>a</sup> Switching duty rated (SWD).

Type BQL Duplex and Quadplex <sup>a</sup>

- 10,000 A interrupting capacity at 120/240 Vac
- Captive line screw included (#2 Robertson/Slot)

<sup>a</sup> HACR rated.

**Table 78. Type BQL Duplex and Quadplex bolt-on classic replacement circuit breakers**

Duplex		Quadplex independent trip							Wire size range (Cu/Al 60 °C or 75 °C) (AWG)	
Two single-pole circuits		Two single-pole circuits and one two-pole circuit				Two two-pole circuits				
Ampere rating		Ampere rating				Ampere rating				
		120 Vac		120/240 Vac		120 Vac		120/240 Vac		
120 Vac	Catalogue number	Outer left (single-pole)	Centre (two-pole)	Outer right (single-pole)	Catalogue number	Outer left and right (two-pole)	Centre (two-pole)	Catalogue number		
15–15	<b>BQLT15</b> <sup>a</sup>	15	15	15	<b>BQLT15215</b>	15	15	<b>BQLT215215</b>	#14–4	
20–20	<b>BQLT20</b> <sup>a</sup>	15	20	15	<b>BQLT15220</b>	20	20	<b>BQLT220220</b>	#14–4	
30–30	<b>BQLT30</b> <sup>a</sup>	15	25	15	<b>BQLT15225</b>	15	30	<b>BQLT215230</b>	#14–4	
—	—	15	30	15	<b>BQLT15230</b>	15	40	<b>BQLT215240</b>	#14–4	
—	—	15	40	15	<b>BQLT15240</b>	—	—	—	#14–4	
Requires one 1-inch (25.4 mm) space		Requires two 1-inch (25.4 mm) spaces				Requires two 1-inch (25.4 mm) spaces				

<sup>a</sup> Switching duty rated (SWD).

**Bolt-on Type BQL ground fault and moulded case switches**

Type BQL ground fault circuit breakers

- 10,000 A interrupting capacity at 120/240 Vac
- 5 mA “people protection”

Product selection

5 mA single- and two-pole bolt-on ground fault circuit breakers are no longer able to be manufactured due to change in UL standard to require all GF devices to “Self Test.”

Type BQL non-automatic circuit breakers (moulded case switches)

- 240 Vac
- Two- and three-pole versions

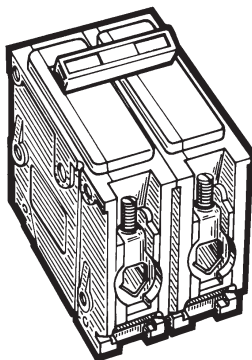

Non-automatic circuit breaker (moulded case switch)

**Table 79. Two- and three-pole bolt-on non-automatic circuit breakers (moulded case switches)**

Ampere rating	Wire size range Cu/Al 60 °C or 75 °C (AWG)	Catalogue number	
		Two-pole, 240 Vac	Three-pole, 240 Vac
60	#8-1 Cu #8-1/0 Al	<b>BQL260NA</b> Requires two 1-inch (25.4 mm) spaces	<b>BQL360NA</b> Requires three 1-inch (25.4 mm) spaces

**Note:** When the Canadian Electrical Code requires the use of an unfused disconnect device as a local isolation switch, then a circuit breaker enclosure may be used in conjunction with a moulded case switch (a.k.a. a non-automatic circuit breaker). For example, with an air conditioning unit, the protective device for these applications is located upstream.

**Bolt-on Type QBH single-, multi-pole and accessories**

## Type QBH

- 120/240 Vac
- 3/4-inch form factor
- Designed to fit the classic CEB, Sylvania or Commander Electric design bolt-on loadcentres
- Suitable for loadcentres, lighting and distribution panelboards, and meter centres
- Silver Tungsten contacts with wiping action to prevent carbon buildup on the contact surface
- Handle provides clear indication of ON/OFF/TRIPPED position
- Quick-make / quick-break mechanism provides tease-proof operation
- Internal common trip mechanism on two-pole circuit breakers
- Each breaker is electronically calibrated for 40 °C
- Compression moulded housing and handle for durability and service

**Table 80. Single- and two-pole bolt-on classic replacement circuit breakers**

Ampere rating	Wire size range 60 °C or 75 °C (AWG)	Catalogue number	
		Single-pole, 120 Vac 10 kAIC	Two-pole, 120/240 Vac 10 kAIC
15	#14–10 Cu, #12–10 Al	<b>QBH15</b>	<b>QBH215</b>
20	#14–10 Cu, #12–10 Al	<b>QBH20</b>	<b>QBH220</b>
25	#14–10 Cu, #12–10 Al	<b>QBH25</b>	<b>QBH225</b>
30	#10–2 Cu, #10–1 Al	<b>QBH30</b>	<b>QBH230</b>
40	#10–2 Cu, #10–1 Al	<b>QBH40</b>	<b>QBH240</b>
50	#10–2 Cu, #10–1 Al	<b>QBH50</b>	<b>QBH250</b>
60	#10–2 Cu, #10–1 Al	<b>QBH60</b>	<b>QBH260</b>
70	#10–2 Cu, #10–1 Al	—	<b>QBH270</b>
90	#10–2 Cu, #10–1 Al	—	<b>QBH290</b>
100	#10–2 Cu, #10–1 Al	—	<b>QBH2100</b>
125	#10–1 Cu	—	<b>QBH2125</b>
		Requires one 3/4-inch (19.1 mm) space	Requires two 3/4-inch (19.1 mm) spaces

## Type QBH accessories

**Table 81. Type QBH classic bolt-on circuit breaker accessories**

Description	Catalogue number
Handle tie	<b>QBHT</b>

**Plug-in Type BJ two- and three-pole****Type BJ <sup>a</sup>**

- Main circuit breakers for classic Westinghouse NovaLine loadcentres
- 10,000 A interrupting capacity at 120/240 Vac

<sup>a</sup> BJ breakers are also approved as branch circuit breakers on CPM/CPL panels 200 A and greater.

**Table 82. Type BJ two- and three-pole plug-in classic replacement circuit breakers**

<b>Ampere rating</b>	<b>Wire size range Cu/Al 60 °C or 75 °C (AWG)</b>	<b>Catalogue number</b>	
		<b>Two-pole, 120/240 Vac 1 per shelf carton 10 kAIC</b>	<b>Three-pole, 120/240 Vac 1 per shelf carton 10 kAIC</b>
125	#2–300 MCM	<b>BJ2125</b>	<b>BJ3125</b>
150	#2–300 MCM	<b>BJ2150</b>	<b>BJ3150</b>
175	#2–300 MCM	<b>BJ2175</b>	<b>BJ3175</b>
200	#2–300 MCM	<b>BJ2200</b>	<b>BJ3200</b>
		Requires four 1-inch (25.4 mm) spaces <sup>a</sup>	Requires six 1-inch (25.4 mm) spaces <sup>b</sup>

<sup>a</sup> When mounted, the Type BJ circuit breakers span both sides of the bus bar occupying an equivalent number of pole spaces on both the left and right side of the loadcentre. For example a two-pole Type BJ circuit breaker occupies 2 pole spaces on the left and the same number of spaces on the right thus requiring four 1-inch spaces.

<sup>b</sup> When mounted, the Type BJ circuit breakers span both sides of the bus bar occupying an equivalent number of pole spaces on both the left and right side of the loadcentre. For example a three-pole Type BJ circuit breaker occupies 3 pole spaces on the left and the same number of spaces on the right thus requiring six 1-inch spaces.



### Pressure switches

- Ensures smooth delivery of water into your home
- Commercial, residential, or agricultural applications
- Can be used on all types of pumps
- Pressure ratings 20–40 PSI, 30–50 PSI, and 40–60 PSI
- Adjustable cut-in and cut-out pressure
- Easy installation
- CSA certified and UL listed
- Pulsation plug models prevent pump cycling due to water surges
- Low pressure cut-off models prevent pump burn out due to lack of well water (10 PSI below turn on pressure)
- 3-year product warranty



Pressure switch

### Product selection

**Table 83. Pressure switches**

Description	Enclosure style	Catalogue number
20–40 PSI pressure switch	NEMA 1	<b>CHWPS2040D</b>
20–40 PSI pressure switch with pulsation plug	NEMA 1	<b>CHWPS2040DP</b>
20–40 PSI pressure switch with low pressure cut-off	NEMA 1	<b>CHWPS2040DL</b>
30–50 PSI pressure switch	NEMA 1	<b>CHWPS3050D</b>
30–50 PSI pressure switch with low pressure cut-off	NEMA 1	<b>CHWPS3050DL</b>
40–60 PSI pressure switch	NEMA 1	<b>CHWPS4060D</b>

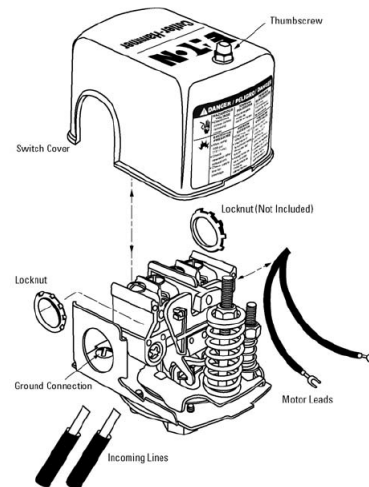

**Table 84. Pressure switch ratings**

Phase	Voltage (AC)	Amperage	Horsepower
Single	115	20	1.5
Handle tie	230	12	2.0

**Table 85. Pressure switch cross-reference**

Description	Catalogue number				
	Eaton	Square DT	Flotec <sup>T</sup>	Water Ace <sup>T</sup>	Furnas <sup>T</sup>
20–40 PSI pressure switch	<b>CHWPS2040D</b>	<b>9013FSG2J20</b>	—	<b>15767A510</b>	<b>69WA4Z2040</b>
20–40 PSI pressure switch with pulsation plug	<b>CHWPS2040DP</b>	<b>9013FSG2J20P</b>	—	—	<b>69WA4Z2040B</b>
20–40 PSI pressure switch with low pressure cut-off	<b>CHWPS2040DL</b>	<b>9013FSG2J20M4</b>	—	—	<b>69WEC</b>
30–50 PSI pressure switch	<b>CHWPS3050D</b>	<b>9013FSG2J21</b>	<b>TC2151</b>	<b>15760A501</b>	<b>69WA4</b>
30–50 PSI pressure switch with low pressure cut-off	<b>CHWPS3050DL</b>	<b>9013FSG2J21M4</b>	<b>FP217-1140</b>	<b>19180A501</b>	—
40–60 PSI pressure switch	<b>CHWPS4060D</b>	<b>9013FSG2J24</b>	<b>TC2153</b>	—	<b>69WA4Z4060</b>

**Notes:**

- CSA is a registered trademark of the Canadian Standards Association
- UL is a federally registered trademark of Underwriters Laboratories Inc.
- NEMA is the registered trademark and service mark of the National Electrical Manufacturers Association
- Square D is a federally registered trademark of Schneider Electric
- Flotec is a registered trademark of Flotec
- Furnas is a registered trademark of Siemens Energy and Automation, Inc.
- Water Ace is a registered trademark of the Pentair Pump Group

**Index**

1SL150PCO	50	3CBL230CU	40	BAB1010	41	BP27	18
1SL300PCO	50	3CBL242	39	BAB1015	41	BP31	18
1SL500PCO	50	3CBL242CU	40	BAB1015D	41	BP32	18
1SL502	51	3CBM118	37	BAB1020	41	BP41	18
1SL502NV	52	3CBM118CU	38	BAB1020D	41	BP54	18
1SL502NVE	52	3CBM130	37	BAB1025	41	BP3110C	15
1SL502S	51	3CBM130CU	38	BAB1030	41	BQHT-10	24
1SL502VE	52	3CBM142	37	BAB1040	41	BQL-10	44
1SL602	51	3CBM142CU	38	BAB1050	41	BQL15	61
1SL602NV	52	3CBM218	37	BAB1060	41	BQL20	61
1SL602NVE	52	3CBM230	37	BAB1070	41	BQL25	61
1SL602S	51	3CBM230CU	38	BAB2015	41	BQL30	61
1SL602VE	52	3CBM242	37	BAB2020	41	BQL40	61
1SL702	51	3CBSF100	44	BAB2030	41	BQL50	61
1SL702NV	52	3CBSF225	44	BAB2040	41	BQL60	61
1SL702NVE	52	3CCPL103	12	BAB2050	41	BQL215	61
1SL702S	51	3CPL112	12	BAB2060	41	BQL220	61
1SL702VE	52	3CPL112COV	15	BAB2070	41	BQL225	61
2SL150PCO	50	3CPL124	12	BAB2090	41	BQL230	61
2SL300PCO	50	3CPL124COV	15	BAB2100	41	BQL240	61
2SL500PCO	50	3CPL130	12	BAB2125	41	BQL250	61
2SL502	51	3CPL130COV	15	BAB3015H	41	BQL260	61
2SL502NV	52	3CPL136	12	BAB3020H	41	BQL260NA	62
2SL502NVE	52	3CPL136COV	15	BAB3030H	41	BQL270	61
2SL502S	51	3CPL218	12	BAB3040H	41	BQL290	61
2SL502VE	52	3CPL218COV	15	BAB3050H	41	BQL315	61
2SL602	51	3CPL224	12	BAB3060H	41	BQL320	61
2SL602NV	52	3CPL224COV	15	BAB3070H	41	BQL330	61
2SL602NVE	52	3CPL230	12	BAB3090H	41	BQL340	61
2SL602S	51	3CPL230COV	15	BAB3100H	41	BQL350	61
2SL602VE	52	3CPL242	12	BHGW-10	24	BQL360	61
2SL702	51	3CPL242COV	15	BHLW1-10	24	BQL360NA	62
2SL702NV	52	3CPL442	12	BHLW2-10	24	BQL370	61
2SL702NVE	52	3CPM112	8	BHLW-10	24	BQL390	61
2SL702S	51	3CPM112COV	15	BJ2125	64	BQL2100	61
2SL702VE	52	3CPM130	8	BJ2150	64	BQL2125	61
2SL706S	51	3CPM130COV	15	BJ2175	64	BQL2135	61
3BRS225	15	3CPM230	8	BJ2200	64	BQL3100	61
3BRS400	15	3CPM230COV	15	BJ3125	64	BQLT-15	61
3BRSF150	15	3CPM442	8	BJ3150	64	BQLT-15-215	61
3CBL118	39	48INT125B	25	BJ3175	64	BQLT-15-220	61
3CBL118CU	40	52-3125-5	15	BJ3200	64	BQLT-15-225	61
3CBL130	39	52-3125-6	15	BP2	18	BQLT-15-230	61
3CBL130CU	40	816INT125B	25	BP4	18	BQLT-15-240	61
3CBL142	39	1224INT125B	25	BP16	18	BQLT-20	61
3CBL142CU	40	1624INT125B	25	BP18	18	BQLT-30	61
3CBL218	39	2024INT125B	25	BP21	18	BQLT-215-215	61
3CBL230	39	2424INT125B	25	BP23	18	BQLT-215-230	61
				BP24	18	BQLT-215-240	61

BQLT-220-220 <b>61</b>	BR320E <b>21</b>	BRH150E <b>21</b>	BRH380E <b>21</b>
BR115 <b>17</b>	BR325 <b>17</b>	BRH160 <b>17</b>	BRH390 <b>17</b>
BR115AF <b>19</b>	BR325E <b>21</b>	BRH160E <b>21</b>	BRH390E <b>21</b>
BR115E <b>21</b>	BR330 <b>17</b>	BRH170 <b>17</b>	BRH2100 <b>17</b>
BR120 <b>17</b>	BR330E <b>21</b>	BRH170E <b>21</b>	BRH2100E <b>21</b>
BR120AF <b>19</b>	BR335 <b>17</b>	BRH215 <b>17</b>	BRH3100 <b>17</b>
BR120E <b>21</b>	BR335E <b>21</b>	BRH215E <b>21</b>	BRH3100E <b>21</b>
BR125 <b>17</b>	BR340 <b>17</b>	BRH220 <b>17</b>	BRL215AF <b>19</b>
BR125E <b>21</b>	BR340E <b>21</b>	BRH220E <b>21</b>	BRL220AF <b>19</b>
BR130 <b>17</b>	BR345 <b>17</b>	BRH225 <b>17</b>	BRL220AFIT <b>19</b>
BR130E <b>21</b>	BR345E <b>21</b>	BRH225E <b>21</b>	BRLAFGFLOFF <b>24</b>
BR135 <b>17</b>	BR350 <b>17</b>	BRH230 <b>17</b>	BRLW1-10 <b>24</b>
BR135E <b>21</b>	BR350E <b>21</b>	BRH230E <b>21</b>	BRLW2-10 <b>24</b>
BR140 <b>17</b>	BR360 <b>17</b>	BRH235 <b>17</b>	BRLW-10 <b>24</b>
BR140E <b>21</b>	BR360E <b>21</b>	BRH235E <b>21</b>	BRQLW-10 <b>24</b>
BR150 <b>17</b>	BR370 <b>17</b>	BRH240 <b>17</b>	BRS225 <b>15</b>
BR150E <b>21</b>	BR370E <b>21</b>	BRH240E <b>21</b>	BRS400 <b>15</b>
BR160 <b>17</b>	BR380 <b>17</b>	BRH245 <b>17</b>	BRSF125 <b>15</b>
BR160E <b>21</b>	BR380E <b>21</b>	BRH245E <b>21</b>	BRSURGE <b>48</b>
BR170 <b>17</b>	BR390 <b>17</b>	BRH250 <b>17</b>	BR230SUR <b>48</b>
BR170E <b>21</b>	BR390E <b>21</b>	BRH250E <b>21</b>	BR250SUR <b>48</b>
BR215 <b>17</b>	BR2100 <b>17</b>	BRH260 <b>17</b>	
BR215E <b>21</b>	BR2100E <b>21</b>	BRH260E <b>21</b>	CBL118 <b>39</b>
BR220 <b>17</b>	BR2100NA <b>22</b>	BRH270 <b>17</b>	CBL118CU <b>40</b>
BR220E <b>21</b>	BR2125 <b>17</b>	BRH270E <b>21</b>	CBL130 <b>39</b>
BR225 <b>17</b>	BR3100 <b>17</b>	BRH280 <b>17</b>	CBL130CU <b>40</b>
BR225E <b>21</b>	BR3100E <b>21</b>	BRH280E <b>21</b>	CBL142 <b>39</b>
BR230 <b>17</b>	BRAF115C <b>19, 41</b>	BRH290 <b>17</b>	CBL142CU <b>40</b>
BR230E <b>21</b>	BRAF120C <b>19</b>	BRH290E <b>21</b>	CBL218 <b>39</b>
BR235 <b>17</b>	BRCAFLOFF <b>24</b>	BRH315 <b>17</b>	CBL218CU <b>40</b>
BR235E <b>21</b>	BRDL1-10 <b>24, 44</b>	BRH315E <b>21</b>	CBL230 <b>39</b>
BR240 <b>17</b>	BRF115 <b>19</b>	BRH320 <b>17</b>	CBL230CU <b>40</b>
BR240E <b>21</b>	BRFP <b>15, 44</b>	BRH320E <b>21</b>	CBL242 <b>39</b>
BR245 <b>17</b>	BRH115 <b>17</b>	BRH325 <b>17</b>	CBL242CU <b>40</b>
BR245E <b>21</b>	BRH115CAF <b>19</b>	BRH325E <b>21</b>	CBM118 <b>37</b>
BR250 <b>17</b>	BRH115E <b>21</b>	BRH330 <b>17</b>	CBM118CU <b>38</b>
BR250E <b>21</b>	BRH120 <b>17</b>	BRH330E <b>21</b>	CBM130 <b>37</b>
BR250NA <b>22</b>	BRH120CAF <b>19</b>	BRH335 <b>17</b>	CBM130CU <b>38</b>
BR260 <b>17</b>	BRH120E <b>21</b>	BRH335E <b>21</b>	CBM142 <b>37</b>
BR260E <b>21</b>	BRH125 <b>17</b>	BRH340 <b>17</b>	CBM142CU <b>38</b>
BR260NA <b>22</b>	BRH125E <b>21</b>	BRH340E <b>21</b>	CBM218 <b>37</b>
BR270 <b>17</b>	BRH130 <b>17</b>	BRH345 <b>17</b>	CBM218CU <b>38</b>
BR270E <b>21</b>	BRH130E <b>21</b>	BRH345E <b>21</b>	CBM230 <b>37</b>
BR280 <b>17</b>	BRH135 <b>17</b>	BRH350 <b>17</b>	CBM230CU <b>38</b>
BR280E <b>21</b>	BRH135E <b>21</b>	BRH350E <b>21</b>	CBM242 <b>37</b>
BR290 <b>17</b>	BRH140 <b>17</b>	BRH360 <b>17</b>	CBSF100 <b>44</b>
BR290E <b>21</b>	BRH140E <b>21</b>	BRH360E <b>21</b>	CBSF225 <b>44</b>
BR315 <b>17</b>	BRH145 <b>17</b>	BRH370 <b>17</b>	CC3100 <b>23</b>
BR315E <b>21</b>	BRH145E <b>21</b>	BRH370E <b>21</b>	CC3125 <b>23</b>
BR320 <b>17</b>	BRH150 <b>17</b>	BRH380 <b>17</b>	CC3150 <b>23</b>

CC3200 <b>23</b>	CH310 <b>31</b>	CHP110 <b>32</b>	CHWPS2040DL <b>65</b>
CCL300 <b>24</b>	CH315 <b>31</b>	CHP115 <b>32</b>	CHWPS2040DP <b>65</b>
CCPL <b>24</b>	CH320 <b>31</b>	CHP120 <b>32</b>	CHWPS3050D <b>65</b>
CCPL102 <b>10</b>	CH325 <b>31</b>	CHP125 <b>32</b>	CHWPS3050DL <b>65</b>
CCPL104 <b>10</b>	CH330 <b>31</b>	CHP130 <b>32</b>	CHWPS4060D <b>65</b>
CCPL108 <b>10</b>	CH335 <b>31</b>	CHP135 <b>32</b>	CPL072 <b>14</b>
CH6L125R <b>30</b>	CH340 <b>31</b>	CHP140 <b>32</b>	CPL072FGP <b>14</b>
CH9FL <b>15</b>	CH345 <b>31</b>	CHP145 <b>32</b>	CPL072R <b>14</b>
CH30SPA <b>47</b>	CH350 <b>31</b>	CHP150 <b>32</b>	CPL072RGP <b>14</b>
CH40SPA <b>47</b>	CH360 <b>31</b>	CHP160 <b>32</b>	CPL072SGP <b>14</b>
CH50SPA <b>47</b>	CH370 <b>31</b>	CHP170 <b>32</b>	CPL112WL <b>10</b>
CH60SPA <b>47</b>	CH380 <b>31</b>	CHP210 <b>32</b>	CPL112G3 <b>46</b>
CH115AF <b>33</b>	CH390 <b>31</b>	CHP215 <b>32</b>	CPL112G6 <b>46</b>
CH115AFPN <b>33</b>	CH3100 <b>31</b>	CHP220 <b>32</b>	CPL116WL <b>10</b>
CH115EPD <b>34</b>	CHF115 <b>31</b>	CHP225 <b>32</b>	CPL116W <b>10</b>
CH115GF <b>34</b>	CHF120 <b>31</b>	CHP230 <b>32</b>	CPL120WL <b>10</b>
CH115GFPN <b>34</b>	CHF125 <b>31</b>	CHP235 <b>32</b>	CPL120G6 <b>46</b>
CH120AF <b>33</b>	CHF130 <b>31</b>	CHP240 <b>32</b>	CPL130WL <b>10</b>
CH120AFPN <b>33</b>	CHF135 <b>31</b>	CHP245 <b>32</b>	CPL130G6 <b>46</b>
CH120EPD <b>34</b>	CHF140 <b>31</b>	CHP250 <b>32</b>	CPL220WL <b>10</b>
CH120GF <b>34</b>	CHF145 <b>31</b>	CHP260 <b>32</b>	CPL240WL <b>10</b>
CH120GFPN <b>34</b>	CHF150 <b>31</b>	CHP270 <b>32</b>	CPL400KIT <b>15</b>
CH125EPD <b>34</b>	CHF215 <b>31</b>	CHP280 <b>32</b>	CPL442 <b>10</b>
CH125GF <b>34</b>	CHF220 <b>31</b>	CHP290 <b>32</b>	CPM112WL <b>6</b>
CH130EPD <b>34</b>	CHF225 <b>31</b>	CHP310 <b>32</b>	CPM116WL <b>6</b>
CH160 <b>31</b>	CHF230 <b>31</b>	CHP315 <b>32</b>	CPM116Z <b>6</b>
CH170 <b>31</b>	CHF235 <b>31</b>	CHP320 <b>32</b>	CPM120WL <b>6</b>
CH215AF <b>33</b>	CHF240 <b>31</b>	CHP325 <b>32</b>	CPM120Z <b>6</b>
CH215EPD <b>34</b>	CHF245 <b>31</b>	CHP330 <b>32</b>	CPM126GEN <b>46</b>
CH215GF <b>34</b>	CHF250 <b>31</b>	CHP335 <b>32</b>	CPM130WL <b>6</b>
CH220AF <b>33</b>	CHFAFGFLOFF <b>36</b>	CHP340 <b>32</b>	CPM130Z <b>6</b>
CH220EPD <b>34</b>	CHFGFT130 <b>34</b>	CHP345 <b>32</b>	CPM140WL <b>6</b>
CH220GF <b>34</b>	CHFGFT130PN <b>34</b>	CHP350 <b>32</b>	CPM140Z <b>6</b>
CH225GF <b>34</b>	CHFP <b>36</b>	CHP360 <b>32</b>	CPM216WL <b>6</b>
CH230EPD <b>34</b>	CHHT <b>36</b>	CHP370 <b>32</b>	CPM220WL <b>6</b>
CH230GF <b>34</b>	CHLO <b>36</b>	CHP2100 <b>32</b>	CPM230WL <b>6</b>
<b>CH230SUR 48</b>	CHM24PN100 <b>30</b>	CHP2110 <b>32</b>	CPM236GEN <b>46</b>
CH235GF <b>34</b>	CHM32PN100 <b>30</b>	CHP2125 <b>32</b>	CPM240WL <b>6</b>
CH240EPD <b>34</b>	CHM32PN200 <b>30</b>	CHP3100 <b>32</b>	CPM260 <b>6</b>
CH240GF <b>34</b>	CHM42PN100 <b>30</b>	CHPL <b>36</b>	CPM342 <b>6</b>
CH245GF <b>34</b>	CHM42PN200 <b>30</b>	CHPLGF <b>36</b>	CPM400KIT <b>15</b>
CH250EPD <b>34</b>	CHM60PN200L <b>30</b>	CHRLS <b>36</b>	CPM442 <b>6</b>
CH250GF <b>34</b>	CHNL24PN125 <b>30</b>	CHSF2125 <b>36</b>	CPM1520WL <b>6</b>
<b>CH250SUR 48</b>	CHNL32PN125 <b>30</b>	CHSPALARM <b>47</b>	CPM1530WL <b>6</b>
CH260 <b>31</b>	CHNL32PN225 <b>30</b>	CHSPCABLE <b>49</b>	CPM1540WL <b>6</b>
CH260EPD <b>34</b>	CHNL42PN225 <b>30</b>	CHSPFMKIT <b>49</b>	CQLP8100 <b>59</b>
CH260GF <b>34</b>	CHNS <b>36</b>	CHSPT2MICRO <b>49</b>	CQLP12100 <b>59</b>
CH270 <b>31</b>	CHNT1515 <b>31</b>	CHSPT2ULTRA <b>49</b>	CSABP4683B <b>59</b>
CH280 <b>31</b>	CHNT1520 <b>31</b>	CHSPT23PACK <b>49</b>	CSABP4734B <b>59</b>
CH290 <b>31</b>	CHNT2020 <b>31</b>	CHWPS2040D <b>65</b>	CSH2100N <b>35</b>

CSH2150N <b>35</b>	GFCBH125 <b>20</b>	P48G11S03P <b>56</b>	QBG2050 <b>43</b>
CSH2200N <b>35</b>	GFCBH130 <b>20</b>	P48G11S05CUB <b>57</b>	QBGFEF1015 <b>43</b>
CSR2125N <b>23</b>	GFCBH215 <b>20</b>	P48G11S05P <b>56</b>	QBGFEF1020 <b>43</b>
CSR2150N <b>23</b>	GFCBH220 <b>20</b>	P48G11S07CUB <b>57</b>	QBGFEF1025 <b>43</b>
CSR2200N <b>23</b>	GFCBH225 <b>20</b>	P48G11S07P <b>56</b>	QBGFEF1030 <b>43</b>
CVRSCRW <b>15</b>	GFCBH230 <b>20</b>	P48G11S10CUB <b>57</b>	QBGFEF2015 <b>43</b>
	GFEP115 <b>20</b>	P48G11S10P <b>56</b>	QBGFEF2020 <b>43</b>
DIRCARD42 <b>44</b>	GFEP120 <b>20</b>	P48G11S15CUB <b>57</b>	QBGFEF2025 <b>43</b>
DIRSLEEVE <b>44</b>	GFEP125 <b>20</b>	P48G11S15P <b>56</b>	QBGFEF2030 <b>43</b>
DNBA1515 <b>42</b>	GFEP130 <b>20</b>	P48G11S25CUB <b>57</b>	QBH15 <b>63</b>
DNBA2020 <b>42</b>	GFEP215 <b>20</b>	P48G11S25P <b>56</b>	QBH20 <b>63</b>
DNBA3030 <b>42</b>	GFEP220 <b>20</b>	P48G28T15CUB <b>57</b>	QBH25 <b>63</b>
DNPL1515 <b>18, 21</b>	GFEP225 <b>20</b>	P48G28T15P <b>56</b>	QBH30 <b>63</b>
DNPL1520 <b>18, 21</b>	GFEP230 <b>20</b>	P48G28T21CUB <b>57</b>	QBH40 <b>63</b>
DNPL1530 <b>18</b>	GFEP240 <b>20</b>	P48G28T21P <b>56</b>	QBH50 <b>63</b>
DNPL2020 <b>18, 21</b>	GFEP250 <b>20</b>	P48G28T30CUB <b>57</b>	QBH60 <b>63</b>
DNPL151515 <b>18</b>	GFXB115B2 <b>22</b>	P48G28T30P <b>56</b>	QBH215 <b>63</b>
DNPL152015 <b>18</b>	GFXB120B2 <b>22</b>	P60G11S03CUB <b>57</b>	QBH220 <b>63</b>
DNPL152515 <b>18</b>	GFXB125B2 <b>22</b>	P60G11S05CUB <b>57</b>	QBH225 <b>63</b>
DNPL153015 <b>18</b>	GFXB130B2 <b>22</b>	P60G11S05P <b>56</b>	QBH230 <b>63</b>
DNPL154015 <b>18</b>		P60G11S07CUB <b>57</b>	QBH240 <b>63</b>
DNPL155015 <b>18</b>	HBQL15 <b>61</b>	P60G11S07P <b>56</b>	QBH250 <b>63</b>
DNPL215215 <b>18</b>	HBQL20 <b>61</b>	P60G11S10CUB <b>57</b>	QBH260 <b>63</b>
DNPL215220 <b>18</b>	HBQL25 <b>61</b>	P60G11S10P <b>56</b>	QBH270 <b>63</b>
DNPL215230 <b>18</b>	HBQL30 <b>61</b>	P60G11S15CUB <b>57</b>	QBH290 <b>63</b>
DNPL215240 <b>18</b>	HBQL40 <b>61</b>	P60G11S15P <b>56</b>	QBH2100 <b>63</b>
DNPL220220 <b>18</b>	HBQL50 <b>61</b>	P60G11S25CUB <b>57</b>	QBH2125 <b>63</b>
DNPL220230 <b>18</b>	HBQL60 <b>61</b>	P60G11S25P <b>56</b>	QBHAF1015 <b>42</b>
DS075H1 <b>15</b>	HBQL315 <b>61</b>	P60G28T15CUB <b>57</b>	QBHAF1020 <b>42</b>
DS100H1 <b>15</b>	HBQL330 <b>61</b>	P60G28T15P <b>56</b>	QBHAF2015 <b>42</b>
DS125H1 <b>15</b>	HBQL350 <b>61</b>	P60G28T21CUB <b>57</b>	QBHAF2015IT <b>42</b>
DS150H1 <b>15</b>	HBQL360 <b>61</b>	P60G28T21P <b>56</b>	QBHAG1020 <b>42</b>
DS200H1 <b>15</b>	HBQL370 <b>61</b>	P60G28T30CUB <b>57</b>	QBHCAF102 <b>42</b>
DS200H2 <b>15</b>	HBQL390 <b>61</b>	P60G28T30P <b>56</b>	QBHCAF1015 <b>42</b>
DS250H2 <b>15</b>	HBQL3100 <b>61</b>		QBHGFEP1015 <b>43</b>
DS300H2 <b>15</b>	HLW1-10 <b>24</b>	QBAF1015 <b>42</b>	QBHGFEP1020 <b>43</b>
GFCB115 <b>20</b>		QBAF1020 <b>42</b>	QBHGFEP1025 <b>43</b>
GFCB120 <b>20</b>	ISGRD <b>15, 44</b>	QBAF2015 <b>42</b>	QBHGFEP1030 <b>43</b>
GFCB125 <b>20</b>		QBAF2015IT <b>42</b>	QBHGFEP2015 <b>43</b>
GFCB130 <b>20</b>	LCCS <b>36</b>	QBAG1020 <b>42</b>	QBHGFEP2020 <b>43</b>
GFCB140 <b>20</b>		QBCAF1015 <b>42</b>	QBHGFEP2025 <b>43</b>
GFCB215 <b>20</b>	MCBL300 <b>24</b>	QBCAF1020 <b>42</b>	QBHGFEP2030 <b>43</b>
GFCB220 <b>20</b>	MCBPL <b>24, 36</b>	QBG1015 <b>43</b>	QBHT <b>63</b>
GFCB225 <b>20</b>		QBG1020 <b>43</b>	QBHW1015 <b>41</b>
GFCB230 <b>20</b>	NL20 <b>15</b>	QBG1030 <b>43</b>	QBHW1020 <b>41</b>
GFCB240 <b>20</b>	NL30 <b>15</b>	QBG1040 <b>43</b>	QBHW1030 <b>41</b>
GFCB250 <b>20</b>	NL300 <b>15</b>	QBG2015 <b>43</b>	QBHW1040 <b>41</b>
GFCB260 <b>20</b>	NSP42 <b>15</b>	QBG2020 <b>43</b>	QBHW1050 <b>41</b>
GFCBH115 <b>20</b>		QBG2030 <b>43</b>	QBHW1060 <b>41</b>
GFCBH120 <b>20</b>	P48G11S03CUB <b>57</b>	QBG2040 <b>43</b>	QBHW1070 <b>41</b>

QBHW2015 <b>41</b>	QLPT19D <b>60</b>	RCPM2GF6H <b>54</b>
QBHW2020 <b>41</b>	QLPT20AD <b>60</b>	RCPM2GF10 <b>54</b>
QBHW2030 <b>41</b>	QLPT22AD <b>60</b>	RCPM108M <b>53</b>
QBHW2040 <b>41</b>	QLPT24D <b>60</b>	RCPM112 <b>7</b>
QBHW2050 <b>41</b>	R3CCPL103 <b>13</b>	RCPM120 <b>7</b>
QBHW2060 <b>41</b>	R3CPL112 <b>13</b>	RCPM130 <b>7</b>
QBHW2070 <b>41</b>	R3CPL130 <b>13</b>	RCPM208M <b>53</b>
QBHW2090 <b>41</b>	R3CPL136 <b>13</b>	RCPM220 <b>7</b>
QBHW2100 <b>41</b>	R3CPL230 <b>13</b>	RCPM230 <b>7</b>
QBHW2125 <b>41</b>	R3CPL242 <b>13</b>	RCPM240 <b>7</b>
QBHW3015 <b>41</b>	R3CPM112 <b>9</b>	RCPM1530 <b>7</b>
QBHW3020 <b>41</b>	R3CPM130 <b>9</b>	RH75P <b>15</b>
QBHW3030 <b>41</b>	R3CPM230 <b>9</b>	RH100P <b>15</b>
QBHW3040 <b>41</b>	RCCHL102 <b>30</b>	RH125P <b>15</b>
QBHW3050 <b>41</b>	RCCPL102 <b>11</b>	SPC61 <b>15</b>
QBHW3060 <b>41</b>	RCCPL104 <b>11</b>	SPCWH <b>15</b>
QBHW3070 <b>41</b>	RCCPL108 <b>11</b>	
QBHW3090 <b>41</b>	RCPL112 <b>11</b>	
QBHW3100 <b>41</b>	RCPL120 <b>11</b>	TDL <b>15, 36, 44</b>
QL1NPL <b>44</b>	RCPL130 <b>11</b>	THOW-10 <b>24</b>
QL23NPL <b>44</b>	RCPL220 <b>11</b>	THS1 <b>24</b>
QL123PL <b>44</b>	RCPL240 <b>11</b>	
QLPT16AD <b>60</b>	RCPM1GF6H <b>54</b>	
QLPT16D <b>60</b>	RCPM1GF10 <b>54</b>	



**Eaton**  
1000 Eaton Boulevard  
Cleveland, OH 44122  
United States  
Eaton.com

Canadian Operations  
5050 Mainway  
Burlington, ON L7L 5Z1  
Canada  
EatonCanada.ca

© 2017 Eaton  
All Rights Reserved  
Printed in Canada  
Publication No. CA003008EN  
December 2017