



# KTLD-40-UV-SC1400-56-VDIM-W1 /USB

## CONSTANT CURRENT PROGRAMMABLE LED DRIVER

### DESCRIPTION

LED Driver | 40W | 120-277V Input | 470-1400mA Programmable Output Current



<b>TOTAL POWER:</b> 40W	<b>OUTPUT CURRENT:</b> 470-1400mA
<b>INPUT VOLTAGE:</b> 120-277Vac $\pm 10\%$	<b>DIMMING:</b> 0-10V
<b>INPUT FREQUENCY:</b> 50/60 Hz	<b>WARRANTY:</b> 5 Years

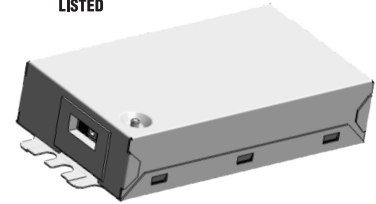

### PRODUCT FEATURES

- Built in USB-C Port for easy programming
- Meets FCC Part 15 (Class B) Consumer Limits
- Short Circuit Overload and Open Load Protection
- Dimmable with 0-10V Dimmer (Down to 1% at Max. Output Current)
- Auxiliary Power: 12Vdc; 200mA Max.
- THD: < 20%
- -20°C/-4°F to 50°C/122°F Operating Temperature
- 90°C/194°F Maximum Case Temperature
- Input Frequency: 50/60 Hz
- Programmable output current via USB-C cable and an Android device (plus Keystone app) or PC (plus Keystone software)
- Class A Sound Rating

### PROGRAMMING FEATURES

- Drive Current (10mA Increments)
- Minimum Dimming Level (1%,3%, 5%,7%, or 10%)
- Dimming Curve (Linear, Log, Inverse Log, or Square-law)
- Minimum Dimming Voltage (1V, 1.5V, or 2V)
- Maximum Dimming Voltage (7V, 8V, or 9V)
- Dim-to-off Voltage (.8V, 1V, 1.2V, or N/A)
- Thermal Foldback Temperature (75°C/167°F, 80°C/176°F, 85°C/185°F, or 90°C/194°F)

**WHAT'S NEEDED?**  
A Smart Current Programmable LED Driver, USB-C Cable, and a computer or phone

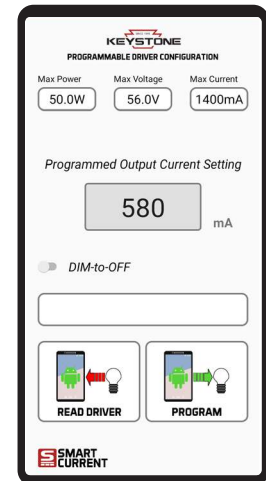

### REQUIRED ACCESSORIES

Order Code	Description
KTLD-SC-USBC	USB-C to USB-C Cable (included with driver)

### ELECTRICAL SPECIFICATIONS

<b>Input Voltage Range</b>	120-277Vac $\pm 10\%$
<b>Frequency</b>	50/60 Hz
<b>Power Factor</b>	>0.9 under 120~277Vac Input with 80~100% Load Condition (For All Output Currents)
<b>Inrush Current</b>	24A <sub>peak</sub> @ 277Vac ; i <sup>2</sup> t = 0.01728 A <sup>2</sup> s
<b>Max. Input Current</b>	0.46A @120V, 0.24A @240V and 0.21A @277V
<b>THD</b>	< 20% under 120~277Vac input with 80~100% load condition (For All Output Currents)
<b>Load Regulation</b>	$\pm 2\%$
<b>Line Regulation</b>	$\pm 1\%$
<b>Output Tolerance</b>	$\pm 5\%$ at Full Load Condition
<b>Turn-On Delay Time</b>	< 2 Seconds at Full Load Condition
<b>Overshoot</b>	< 10% at Full Load Condition
<b>No Load Power Consumption</b>	< 1.5W
<b>Ripple and Noise (pk-pk)</b>	< 3%
<b>Withstand Voltage</b>	Input to output, 2,800Vdc, 2mA
<b>Leakage Current</b>	Maximum 0.5mA at 277Vac, 60Hz input
<b>Protection</b>	<ul style="list-style-type: none"> <li>• <b>Over Voltage Protection:</b> Hiccup mode. Protection will trigger when load voltage exceed specified output voltage and will auto recover after the fault mode is removed.</li> <li>• <b>Over Current Protection:</b> Hiccup mode. Protection will trigger when load current exceed specified output current and will auto recover after the fault mode is removed.</li> <li>• <b>Short Circuit Protection:</b> Hiccup mode. Protection will trigger when short circuit and will auto recover after the fault mode is removed.</li> <li>• <b>Over Temperature Protection:</b> Protection will trigger when driver overheat and auto-recovery when cooled down.</li> </ul>



# KTLD-40-UV-SC1400-56-VDIM-W1 /USB

## CONSTANT CURRENT PROGRAMMABLE LED DRIVER

### PRODUCT SPECIFICATIONS

Max. Output Power	Output Current	Output Voltage	OCV	Typical Efficiency at 120V	Typical Efficiency at 240V	Typical Efficiency at 277V	Remote Mounting Distance (#18 AWG)	Class 2	
								US	Canada
40W	470-1400mA	10-56V	60V	87%	87%	88%	26 ft.	✓	

### PHYSICAL SPECIFICATIONS

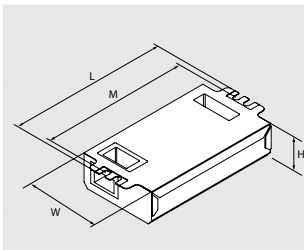

<b>LENGTH</b>	5.00"
<b>WIDTH</b>	2.38"
<b>HEIGHT</b>	1.00"
<b>MOUNTING</b>	4.62"
<b>CASE STYLE</b>	W1
<b>CASE MATERIAL</b>	Metal

### WIRING SPECIFICATIONS

<b>INPUT</b>	Terminal Block
<b>OUTPUT</b>	Terminal Block
<b>DIMMING</b>	Terminal Block

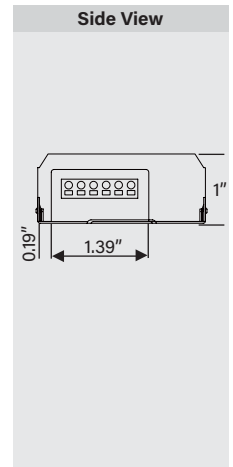
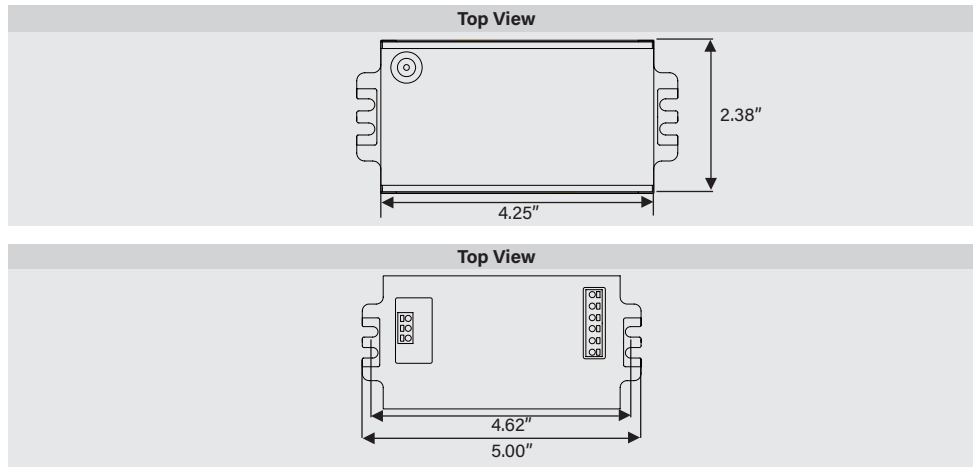
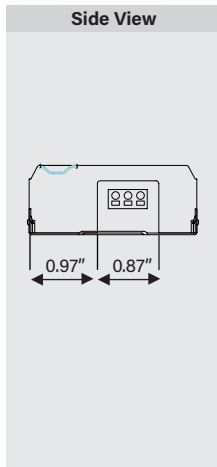

### Wiring

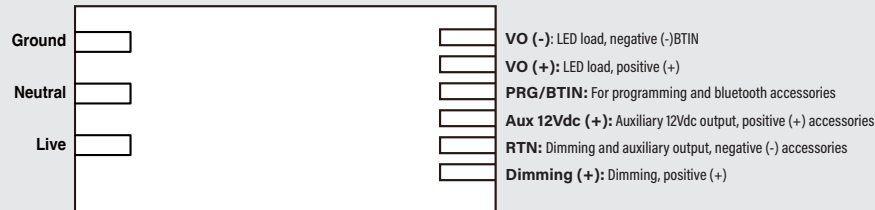

### ENVIRONMENTAL SPECIFICATIONS

<b>Operating Temperature</b>	-20°C/-4°F to 50°C/122°F
<b>Storage Temperature</b>	-40°C/-40°F to 85°C/185°F
<b>Humidity</b>	5% to 95%
<b>MTBF</b>	397,500 hours at 40°C ambient (~70°C Case temp)
<b>Life Rating</b>	85,000 hours at 120Vac input, 100% load and 60°C case temperature
<b>Maximum Case Temperature</b>	90°C



# KTLD-40-UV-SC1400-56-VDIM-W1 /USB

## CONSTANT CURRENT PROGRAMMABLE LED DRIVER

### SAFETY AND EMC COMPLIANCE

<b>UL/cUL</b>	UL 8750 Pending, UL1310 Class 2
<b>CE</b>	EN61347-1, EN61347-2-13
<b>FCC, 47CFR Part 15</b>	ANSI C63.4:2009 Class B (Consumer Limit)
<b>EN61000-3-2</b>	Harmonic Current Emissions Class C

### LED DRIVER OUTPUT WINDOW

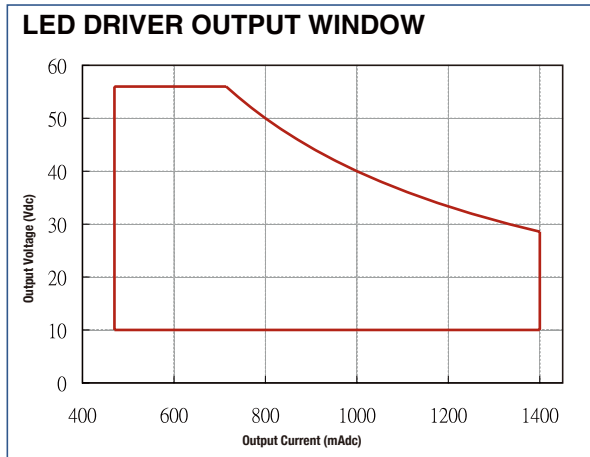

Note: Driver is in Constant Power mode from 700mA to 1400mA.

### ORDERING INFORMATION

Order Code	Packaging Style	Pack Quantity	Item Status
KTLD-40-UV-SC1400-56-VDIM-W1 /USB	Carton Pack	50	Quick Ship

### CATALOG NUMBER BREAKDOWN

# KTLD-40-UV-SC1400-56-VDIM-W1 /USB

- 1
- 2
- 3
- 4
- 5
- 6
- 7
- 8
- 9

- 1** Keystone Technologies LED Driver
- 2** Max. Output Wattage
- 3** 120-277V Input
- 4** Smart Current
- 5** Max. Output Current
- 6** Max. Output Voltage
- 7** 0-10V Dimming
- 8** Case Style
- 9** USB Port