

- Etched polypropylene face
- Face anchored in concrete
- Ultra-violet inhibitor
- Exceeds ASTM-D1693 Standards for Environmental Stress Cracking Resistance

**R-Series Composite Lid
No. N09R
20 lbs.**

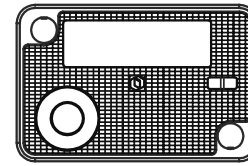
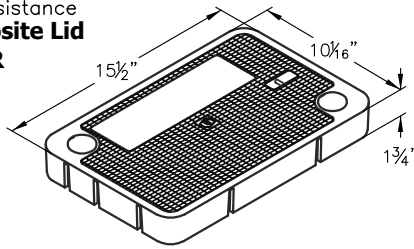

N09RP

**Utility Box
No. B09 BOX
90 lbs.**

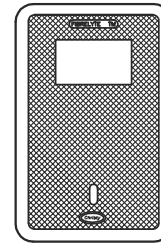
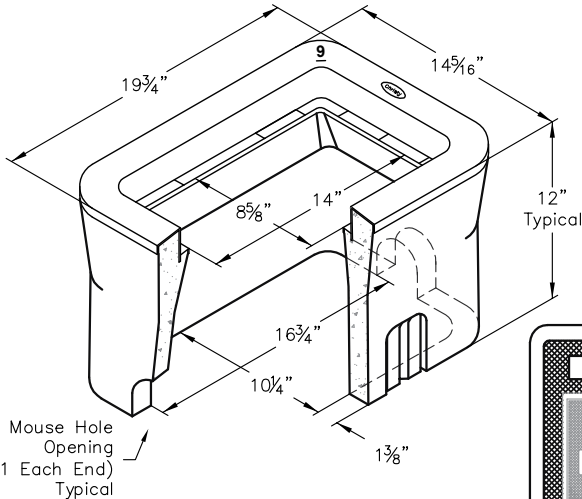

FL09D

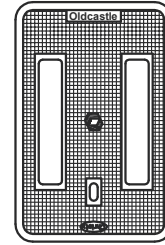

B09C

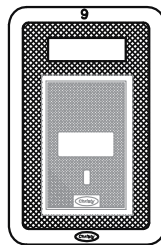

B09G

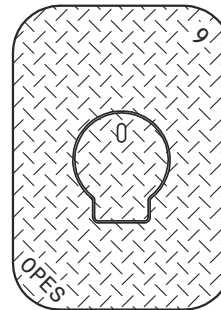

B09-61G

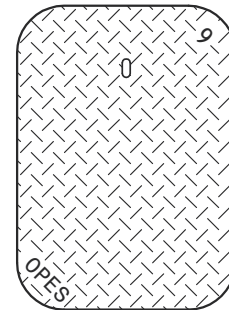

B09-61D

A high density reinforced concrete box with non-settling shoulders positioned to maintain grade and facilitate back filling. Approximate dimensions and weight shown.

Oldcastle Ordering Code	Item	Approx. Shipping Weight	Description
B09BOX	BOX	90 lbs.	B09 Utility Box (10 1/4" x 16 3/4") interchangeable with Brooks #36 Box - 28 per pallet
B09C	LID	22 lbs.	Cast Iron Lid
N09R	LID	20 lbs.	R-Series Composite Lid with Polypropylene Ring (Order N90 Bolt Down Kit Separately)
FL09D	LID	5 lbs.	Fibrelyte Lid, Non-Concrete
N09RP	LID	20 lbs.	R-Series Composite Lid with Polypropylene Ring w/ ø2" Probe Hole for Meter Reading Probe (Order N90 Bolt Down Kit Separately)
B09G	LID	18 lbs.	Reinforced Concrete Lid with 5" x 8" Cast Iron, Self-Closing, Reading Lid with Frame
B09TL	LID	23 lbs.	Cast Iron Lid with Lock
BUTLK	KEY	1 lbs.	Universal TL Key for Cast Iron Lids with Lock
B09-61D	COVER	22 lbs.	Steel Checker Plate Cover
B09-61G	COVER	22 lbs.	Steel Checker Plate Cover with 6" Round, Self-Closing Reading Lid
B09X12	EXTENSION	87 lbs.	12" Reinforced Concrete Box Extension - 28 per pallet
B09SL	SLAB	32 lbs.	Reinforced Concrete Slab (13 3/4" x 19 3/4")

Galvanizing available on all steel covers.



Phone: (800) 486-7070 Fax: (800) 486-6804
Copyright © 2011 Oldcastle Precast Inc.

B09 BOX

FILE NAME: B09_ISO

ISSUE DATE: January, 2011

www.oldcastleprecast.com

**B09 UTILITY BOX
10-1/4" X 16-3/4"**

