

JUNO

2" IC 600 AND 1000 LUMENS LED ROUND DOWNLIGHT CONE

Project: _____

Fixture Type: _____

Location: _____

Contact/Phone: _____

**2LEDTRIM G2 DC**

PRODUCT DESCRIPTION

2 inch aperture recessed downlight is IC rated for insulated or non-insulated applications • Luminaire produces up to 1000 lumens and is available with optical distributions approximating that of 75W MR16 halogen lamps • Low profile form factor allows luminaire to fit in 2 x 6 construction • Designed to provide 50,000 hours of life • 5 year limited warranty on LED Components.

ENVIRONMENTALLY FRIENDLY, ENERGY EFFICIENT

- No harmful ultraviolet or infrared wavelengths
- No lead or mercury, RoHS compliant
- Comparable light output up to a 75W MR16 halogen lamp

PRODUCT SPECIFICATIONS

LED Light Engine Exceptional fixture to fixture color consistency within a 3-step MacAdam ellipse • 2700K, 3000K, 3500K, and 4000K color temperatures are available with 80 CRI or 90 CRI minimum.

Modular Optics Available with field interchangeable optics in 18° Spot, 24° Narrow Flood, or 40° Flood distributions.

Aesthetic Trim Trim features die cast beveled knife edge trim ring for clean ceiling interface available in white, black, satin nickel, or brushed bronze • Spun aluminum reflectors are available in clear, haze, wheat haze, black and white finishes.

LED Driver Choice of dedicated 120 volt (120) driver or universal voltage (MVOLT) driver that accommodates input voltages from 120-277 volts AC at 50/60Hz • Power factor > 0.9 • Dedicated 120 volt driver (120) is dimmable with the use of most incandescent, magnetic low voltage and electronic low voltage dimmers • Universal voltage driver (MVOLT) is dimmable with the use of most 0-10V protocol dimmers • For a list of compatible dimmers, see [JUNO2ING2-DIM](#).

Life Rated for 50,000 hours at 70% lumen maintenance.

Labels 90CRI fixtures are certified to the high efficacy requirements of California T24 JA8-2019 • Meets energy code Air Leakage requirements per ASTM E283 • UL and cUL listed for wet locations • 2NCHSG option is compatible with spray foam insulation with an R-value of 3.2 per inch or less.

Junction Box Includes (2) 1/2" knock-outs equipped with pryout slots • Push-in electrical connectors for field connections.

Mounting Remodel style plaster frame installs from below the ceiling and accommodates ceiling thicknesses from 1/2" to 1" • For thicker ceilings up to 1 1/2", order 2JCTA150 • New Construction mounting frame, 2NCMFLP, is also available with Patented (US Patent D552,969) Real Nail 3° telescoping bar hangers to position fixture and locate wiring prior to ceiling installation • Recommend a minimum of 5.5" cavity depth to install properly • Flexible supply is recommended and non-flexible supply requires top access.

Real Nail 3 Bar Hangers 2NCHSG new construction housing and new construction mounting frame, 2NCMFLP, available with telescoping Real Nail® 3 system which permits quick placement of housing anywhere within 24" O.C. joists or suspended ceilings • Includes removable nail for repositioning of fixture in wood joist construction • Integral T-bar notch and clip for suspended ceilings • Design covered under US Patent D552,969 • 2NCHSG requires 2x8 construction

Specifications subject to change without notice.

Downlight Cone Finishes

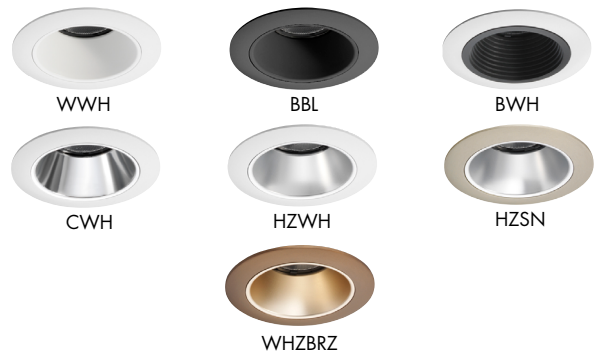

DIMENSIONS

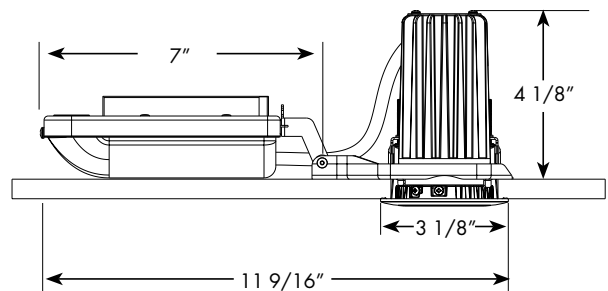

2 5/8" CEILING CUTOUT
2" APERTURE

ELECTRICAL DATA (600L)

	Dedicated 120V (120)	Universal Voltage (MVOLT)	
		120	277
Voltage	120	120	277
Input Power	7.5 (±5%)	7.2	7.5 (±5%)
Input Current	.06	.06	.03
Frequency	50/60Hz	50/60Hz	
Power Factor	>0.9	>0.9	>0.9

ELECTRICAL DATA (1000L)

	Dedicated 120V (120)	Universal Voltage (MVOLT)	
		120	277
Voltage	120	120	277
Input Power	11.5 (±5%)	10.9	11.4 (±5%)
Input Current	.10	.09	.04
Frequency	50/60Hz	50/60Hz	
Power Factor	>0.9	>0.9	>0.9

2" IC 600 AND 1000 LUMENS LED ROUND DOWNLIGHT CONE 2LEDTRIM G2 DC

ORDERING INFORMATION DRIVER AND TRIM EACH ORDERED SEPARATELY.

DRIVER:

Example: 2LEDDRIVER G2 06LM 120 FRPC

Series	Generation	Lumens	Voltage	Driver
2LEDDRIVER Juno Recessed 2" Driver	G2 Generation 2	06LM 600 Nominal Lumens 10LM 1000 Nominal Lumens	120 120V MVOLT Multi-Volt (120-277V)	FRPC Forward/Reverse Phase Cut ZT 0-10V Dimming

Note: 120V must be ordered with FRPC.
MVOLT must be ordered with ZT

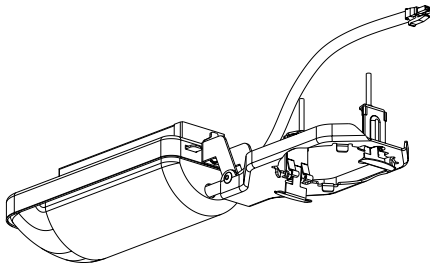

MOUNTING FRAME/DRIVER ASSEMBLY

Note: Driver assembly only intended for use with Gen2 LED trim modules.
Not backward compatible with previous generation.

TRIM:

Example: 2LEDTRIM G2 DC 27K 80CRI FL BBL

Series	Generation	Trim Designation	Color Temperature	CRI	Distribution	Trim Finish
2LEDTRIM Juno Recessed 2" LED Trim	G2 Generation 2	DC Downlight Cone	27K 2700K 30K 3000K 35K 3500K 40K 4000K	80CRI 80+ CRI 90CRI 90+ CRI	FL Flood NFL Narrow Flood SP Spot	BBL Black Reflector, Black Trim Ring BWH Black Reflector, White Trim Ring CWH Clear Alzak Reflector, White Trim Ring HZWH Haze Reflector, White Trim Ring WWH White Reflector, White Trim Ring WHZBRZ Wheat Haze Reflector, Bronze Trim Ring HZSN Haze Reflector, Satin Nickel Trim Ring

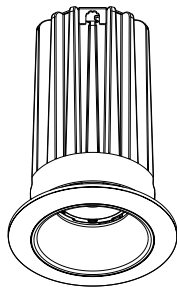

TRIM/LED ASSEMBLY

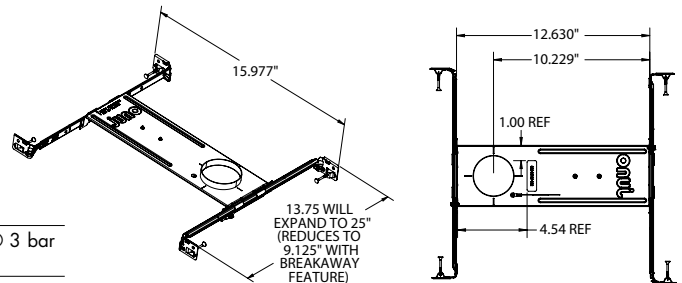

2NCMFLP

Catalog No.	Description
2NCMFLP	New Construction Mounting Frame with Lip and Real Nail® 3 bar hangers
2NCHSG	2" New Construction Housing for spray foam installation
2DTCA	2" LED Drop Tile Ceiling Adapter
2JCTA150	Thick Ceiling adapter for 1" - 1 1/2" thick ceiling
LEDOPTIC2 SP	18° Spot Optic
LEDOPTIC2 NFL	24° Narrow Flood Optic
LEDOPTIC2 FL	40° Flood Optic

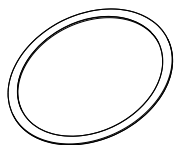

2DTCA

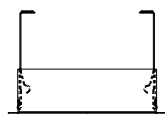

2JCTA150

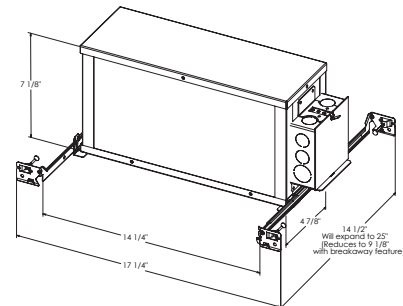
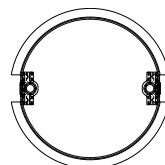

2NCHSG

2" IC 600 AND 1000 LUMENS LED ROUND DOWNLIGHT CONE 2LEDTRIM G2 DC

PHOTOMETRICS

PHOTOMETRIC REPORT

Test Report#: PT07162131
 Catalog No: 2LEDTRIM G2 DC 35K 80CRI
 SP CWH (600L), Clear Cone
 with Spot Optic
 Luminaire Spacing Criteria: 0.34
 Luminaire LPW: 103

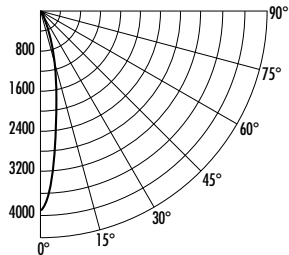

CANDLEPOWER DISTRIBUTION (Candelas)

Degrees Vertical	0°
0	3972
5	3449
15	1007
25	318
35	53
45	12
55	2
65	0
75	0
85	0
90	0

AVERAGE INITIAL FOOTCANDLES

Multiple Units (Square Array, 60'x60' room)
 Reflectances: Ceiling 80%, Wall 50%, Floor 20%

Spacing	RCR1	RCR3	RCR5
4'	55	50	46
5'	35	32	29
6'	24	22	20
7'	20	18	17
8'	16	14	13
9'	12	11	10
10'	9	8	7

INITIAL FOOTCANDLES

(One Unit, 7.5W, 19.6° Beam)

Distance to Illuminated Plane (Feet)	Footcandles Beam Center	Beam Diameter
4'	248.3	1.4
6'	110.3	2.1
8'	62.1	2.8
10'	39.7	3.5
12'	27.6	4.1

ZONAL LUMEN SUMMARY

Zone	Lumens	%Lamp	%Fixture
0-30°	718	N/A	92.8
0-40°	762	N/A	98.5
0-60°	774	N/A	100.0
0-90°	774	N/A	100.0

LUMINANCE (Average cd/m²)

Degrees	Average Luminance
45°	6383
55°	1455
65°	0
75°	0
85°	0

PHOTOMETRIC REPORT

Test Report#: PT07162136
 Catalog No: 2LEDTRIM G2 DC 35K 80CRI
 NFL CWH (600L), Clear Cone
 with Narrow Flood Optic
 Luminaire Spacing Criteria: 0.42
 Luminaire LPW: 100

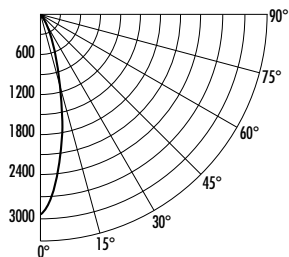

CANDLEPOWER DISTRIBUTION (Candelas)

Degrees Vertical	0°
0	2963
5	2681
15	1032
25	344
35	64
45	11
55	3
65	0
75	0
85	0
90	0

AVERAGE INITIAL FOOTCANDLES

Multiple Units (Square Array, 60'x60' room)
 Reflectances: Ceiling 80%, Wall 50%, Floor 20%

Spacing	RCR1	RCR3	RCR5
4'	53	48	43
5'	34	30	28
6'	23	21	19
7'	19	17	16
8'	15	14	12
9'	11	10	9
10'	8	8	7

INITIAL FOOTCANDLES

(One Unit, 7.5W, 24.3° Beam)

Distance to Illuminated Plane (Feet)	Footcandles Beam Center	Beam Diameter
4'	185.2	1.7
6'	82.3	2.6
8'	46.3	3.4
10'	29.6	4.3
12'	20.6	5.2

ZONAL LUMEN SUMMARY

Zone	Lumens	%Lamp	%Fixture
0-30°	686	N/A	91.8
0-40°	735	N/A	98.3
0-60°	747	N/A	100.0
0-90°	747	N/A	100.0

LUMINANCE (Average cd/m²)

Degrees	Average Luminance
45°	5900
55°	1785
65°	0
75°	0
85°	0

PHOTOMETRIC REPORT

Test Report#: PT07162141
 Catalog No: 2LEDTRIM G2 DC 35K 80CRI
 FL CWH (600L), Clear Cone
 with Flood Optic
 Luminaire Spacing Criteria: 0.58
 Luminaire LPW: 103

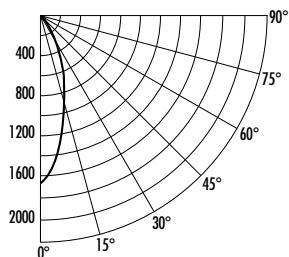

CANDLEPOWER DISTRIBUTION (Candelas)

Degrees Vertical	0°
0	1669
5	1524
15	968
25	519
35	167
45	21
55	3
65	0
75	0
85	0
90	0

AVERAGE INITIAL FOOTCANDLES

Multiple Units (Square Array, 60'x60' room)
 Reflectances: Ceiling 80%, Wall 50%, Floor 20%

Spacing	RCR1	RCR3	RCR5
4'	54	48	43
5'	35	31	28
6'	24	21	19
7'	20	17	15
8'	15	14	12
9'	12	10	9
10'	9	8	7

INITIAL FOOTCANDLES

(One Unit, 7.5W, 35.7° Beam)

Distance to Illuminated Plane (Feet)	Footcandles Beam Center	Beam Diameter
4'	104.3	2.6
6'	46.4	3.9
8'	26.1	5.2
10'	16.7	6.4
12'	11.6	7.7

ZONAL LUMEN SUMMARY

Zone	Lumens	%Lamp	%Fixture
0-30°	644	N/A	83.1
0-40°	752	N/A	97.1
0-60°	775	N/A	100.0
0-90°	775	N/A	100.0

LUMINANCE (Average cd/m²)

Degrees	Average Luminance
45°	11157
55°	1785
65°	0
75°	0
85°	0

Fixtures tested to IES recommended standard for solid state lighting per LM-79-08. Photometric performance on a single unit represents a baseline of performance for the fixture. Results may vary in the field.

Multiplier:	80 CRI	90 CRI
	27K = .94	27K = .83
	30K = .97	30K = .86
	35K = 1.00	35K = .88
	40K = 1.03	40K = .90

2" IC 600 AND 1000 LUMENS LED ROUND DOWNLIGHT CONE 2LEDTRIM G2 DC

PHOTOMETRICS

PHOTOMETRIC REPORT

Test Report#: PT07162131R
 Catalog No: 2LEDTRIM G2 DC 35K 80CRI
 SP CWH (1000L), Clear Cone
 with Spot Optic
 Luminaire Spacing Criteria: 0.34
 Luminaire LPW: 102

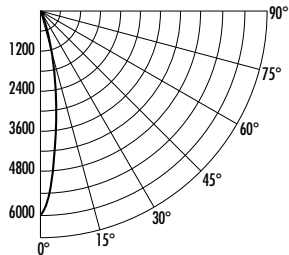

CANDLEPOWER DISTRIBUTION (Candelas)

Degrees Vertical	0°
0	5997
5	5209
15	1520
25	481
35	80
45	18
55	3
65	0
75	0
85	0
90	0

AVERAGE INITIAL FOOTCANDLES

Multiple Units (Square Array, 60'x60' room)
 Reflectances: Ceiling 80%, Wall 50%, Floor 20%

Spacing	RCR1	RCR3	RCR5
4'	83	75	69
5'	53	48	44
6'	37	33	31
7'	30	27	25
8'	23	21	20
9'	18	16	15
10'	13	12	11

INITIAL FOOTCANDLES

(One Unit, 11.5W, 19.6° Beam)

Distance to Illuminated Plane (Feet)	Footcandles Beam Center	Beam Diameter
4'	374.8	1.4
6'	166.6	2.1
8'	93.7	2.8
10'	60.0	3.5
12'	41.6	4.1

ZONAL LUMEN SUMMARY

Zone	Lumens	%Lamp	%Fixture
0-30°	1085	N/A	92.8
0-40°	1151	N/A	98.5
0-60°	1168	N/A	100.0
0-90°	1169	N/A	100.0

LUMINANCE (Average cd/m²)

Degrees	Average Luminance
45°	9638
55°	2197
65°	0
75°	0
85°	0

PHOTOMETRIC REPORT

Test Report#: PT07162136R
 Catalog No: 2LEDTRIM G2 DC 35K 80CRI
 NFL CWH (1000L), Clear Cone
 with Narrow Flood Optic
 Luminaire Spacing Criteria: 0.42
 Luminaire LPW: 99

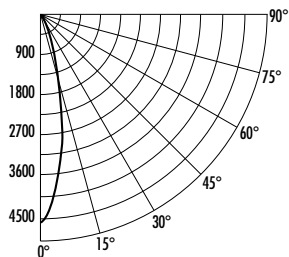

CANDLEPOWER DISTRIBUTION (Candelas)

Degrees Vertical	0°
0	4533
5	4102
15	1579
25	526
35	98
45	17
55	4
65	0
75	0
85	0
90	0

AVERAGE INITIAL FOOTCANDLES

Multiple Units (Square Array, 60'x60' room)
 Reflectances: Ceiling 80%, Wall 50%, Floor 20%

Spacing	RCR1	RCR3	RCR5
4'	81	73	66
5'	52	47	43
6'	36	32	30
7'	29	26	24
8'	23	21	19
9'	18	16	14
10'	13	12	11

INITIAL FOOTCANDLES

(One Unit, 11.5W, 24.3° Beam)

Distance to Illuminated Plane (Feet)	Footcandles Beam Center	Beam Diameter
4'	283.3	1.7
6'	125.9	2.6
8'	70.8	3.4
10'	45.3	4.3
12'	31.5	5.2

ZONAL LUMEN SUMMARY

Zone	Lumens	%Lamp	%Fixture
0-30°	1049	N/A	91.8
0-40°	1124	N/A	98.3
0-60°	1143	N/A	100.0
0-90°	1143	N/A	100.0

LUMINANCE (Average cd/m²)

Degrees	Average Luminance
45°	9027
55°	2732
65°	0
75°	0
85°	0

PHOTOMETRIC REPORT

Test Report#: PT07162141R
 Catalog No: 2LEDTRIM G2 DC 35K 80CRI
 FL CWH (1000L), Clear Cone
 with Flood Optic
 Luminaire Spacing Criteria: 0.58
 Luminaire LPW: 104

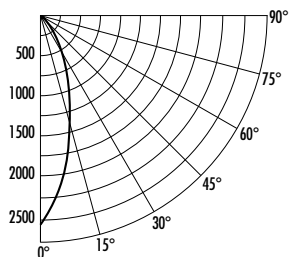

CANDLEPOWER DISTRIBUTION (Candelas)

Degrees Vertical	0°
0	2571
5	2346
15	1490
25	799
35	256
45	32
55	4
65	0
75	0
85	0
90	0

AVERAGE INITIAL FOOTCANDLES

Multiple Units (Square Array, 60'x60' room)
 Reflectances: Ceiling 80%, Wall 50%, Floor 20%

Spacing	RCR1	RCR3	RCR5
4'	84	74	66
5'	53	47	42
6'	37	33	29
7'	30	27	24
8'	24	21	19
9'	18	16	14
10'	13	12	11

INITIAL FOOTCANDLES

(One Unit, 11.5W, 35.7° Beam)

Distance to Illuminated Plane (Feet)	Footcandles Beam Center	Beam Diameter
4'	160.7	2.6
6'	71.4	3.9
8'	40.2	5.2
10'	25.7	6.4
12'	17.9	7.7

ZONAL LUMEN SUMMARY

Zone	Lumens	%Lamp	%Fixture
0-30°	991	N/A	83.1
0-40°	1159	N/A	97.1
0-60°	1193	N/A	100.0
0-90°	1193	N/A	100.0

LUMINANCE (Average cd/m²)

Degrees	Average Luminance
45°	17182
55°	2750
65°	0
75°	0
85°	0

Fixtures tested to IES recommended standard for solid state lighting per LM-79-08. Photometric performance on a single unit represents a baseline of performance for the fixture. Results may vary in the field.

Multiplier:	80 CRI	90 CRI
	27K = .94	27K = .83
	30K = .97	30K = .86
	35K = 1.00	35K = .88
	40K = 1.03	40K = .90