



# KTLD-85-UV-SC2600-56-VDIM-U4 /USB

## CONSTANT CURRENT PROGRAMMABLE LED DRIVER

### DESCRIPTION

LED Driver | 85W | 120-277V Input | 860-2600mA Programmable Output Current



<b>TOTAL POWER:</b> 85W	<b>OUTPUT CURRENT:</b> 860-2600mA
<b>INPUT VOLTAGE:</b> 120-277Vac ±10%	<b>DIMMING:</b> 0-10V
<b>INPUT FREQUENCY:</b> 50/60 Hz	<b>WARRANTY:</b> 5 Years



### PRODUCT FEATURES

- Built in USB-C Port for easy programming
- Meets FCC Part 15 (Class B) consumer limits
- Short circuit overload and open load protection
- Dimmable with 0-10V dimmer (down to 1% at max. output current)
- Auxiliary Power: 12Vdc; 200mA max.
- THD: < 20%
- 20°C/-4°F to 50°C/122°F operating temperature
- 90°C/194°F maximum case temperature
- Input frequency: 50/60 Hz
- Programmable output current via USB-C cable and an Android device (plus Keystone app) or PC (plus Keystone software)
- Class A Sound Rating

### PROGRAMMING FEATURES

- Drive current (10mA increments)
- Minimum dimming level (1%, 3%, 5%, 7%, or 10%)
- Dimming curve (linear, log, inverse log, or square-law)
- Minimum dimming voltage (1V, 1.5V, or 2V)
- Maximum dimming voltage (7V, 8V, or 9V)
- Dim-to-off voltage (0.8V, 1V, 1.2V, or N/A)
- Thermal foldback temperature (75°C/167°F, 80°C/176°F, 85°C/185°F, or 90°C/194°F)

**WHAT'S NEEDED?**  
A Smart Current Programmable LED Driver, USB-C Cable, and a computer or phone

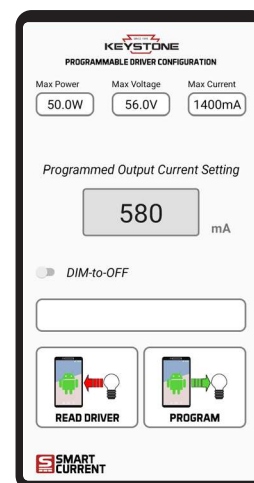

### REQUIRED ACCESSORIES

Order Code	Description
KTLD-SC-USBC	USB-C to USB-C Cable (included with driver)

### ELECTRICAL SPECIFICATIONS

<b>Input Voltage Range</b>	120-277Vac ±10%
<b>Frequency</b>	50/60 Hz
<b>Power Factor</b>	>0.9 under 120~277Vac Input with 80~100% load condition (for all output currents)
<b>Inrush Current</b>	29A <sub>peak</sub> @ 277Vac; i <sup>2</sup> t = 0.026912 A <sup>2</sup> s
<b>Max. Input Current</b>	0.89A @120V, 0.44A @240V, and 0.38A @277V
<b>THD</b>	<20% under 120~277Vac input with 80~100% load condition (for all output currents)
<b>Load Regulation</b>	± 2%
<b>Line Regulation</b>	± 1%
<b>Output Tolerance</b>	± 5% at full load condition
<b>Turn-On Delay Time</b>	<0.75 seconds at full load condition
<b>Overshoot</b>	<10% at full load condition
<b>No Load Power Consumption</b>	<2W
<b>Ripple and Noise (pk-pk)</b>	<3%
<b>Withstand Voltage</b>	Input to output, 2,800Vdc, 2mA
<b>Leakage Current</b>	Maximum 0.5mA at 277Vac, 60Hz input
<b>Protection</b>	<ul style="list-style-type: none"> <li>• <b>Over Voltage Protection:</b> Hiccup mode. Protection will trigger when load voltage exceeds specified output voltage and will auto recover after the fault mode is removed.</li> <li>• <b>Over Current Protection:</b> Hiccup mode. Protection will trigger when load current exceeds specified output current and will auto recover after the fault mode is removed.</li> <li>• <b>Short Circuit Protection:</b> Hiccup mode. Protection will trigger when short circuit and will auto recover after the fault mode is removed.</li> <li>• <b>Over Temperature Protection:</b> Protection will trigger when driver overheats and auto-recovery when cooled down.</li> </ul>



# KTLD-85-UV-SC2600-56-VDIM-U4 /USB

## CONSTANT CURRENT PROGRAMMABLE LED DRIVER

### PRODUCT SPECIFICATIONS

Max. Output Power	Output Current	Output Voltage	OCV	Typical Efficiency at 120V	Typical Efficiency at 240V	Typical Efficiency at 277V	Remote Mounting Distance (#18 AWG)	Class 2	
								US	Canada
85W	860-2600mA	10-56V	60V	90%	90%	90%	24 ft.	✓	

### PHYSICAL SPECIFICATIONS

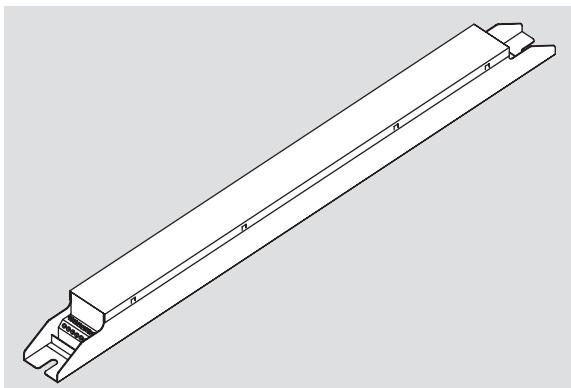

LENGTH	16.89"	MOUNTING	16.02"
WIDTH	1.18"	CASE STYLE	U4
HEIGHT	1.00"	CASE MATERIAL	Metal

#### TOP VIEW

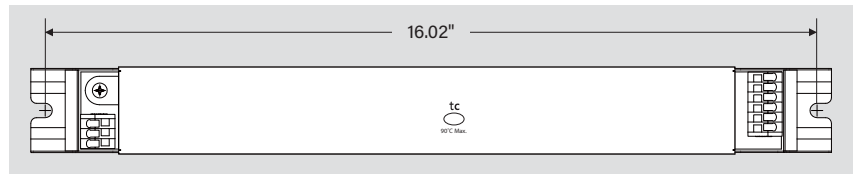

#### FRONT VIEW

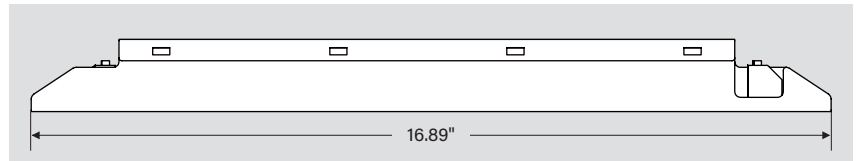

#### SIDE VIEW

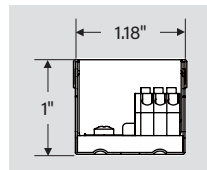

### WIRING SPECIFICATIONS

INPUT	Terminal Block
OUTPUT	Terminal Block
DIMMING	Terminal Block

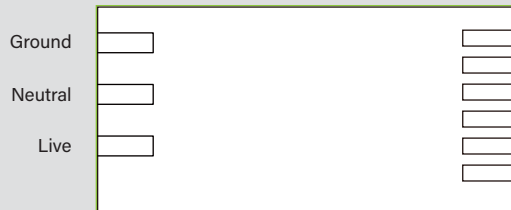

- VO (-):** LED load, negative (-)BTIN
- VO (+):** LED load, positive (+)
- PRG/BTIN:** For programming and bluetooth accessories
- Aux 12Vdc (+):** Auxiliary 12Vdc output, positive (+) accessories
- RTN:** Dimming and auxiliary output, negative (-) accessories
- Dimming (+):** Dimming, positive (+)

# KTLD-85-UV-SC2600-56-VDIM-U4 /USB

## CONSTANT CURRENT PROGRAMMABLE LED DRIVER

### ENVIRONMENTAL SPECIFICATIONS

Operating Temperature	-20°C/-4°F to 50°C/122°F
Storage Temperature	-40°C/-40°F to 85°C/185°F
Humidity	5% to 95%
MTBF	209,100 hours at 40°C/104°F ambient (~70°C/~94°F case temperature)
Life Rating	85,000 hours at 120Vac input, 100% load and 60°C/140°F case temperature
Maximum Case Temperature	90°C/194°F

### SAFETY AND EMC COMPLIANCE

UL/cUL	UL 8750, Class P, Type HL, UL1310 Class 2
CE	EN61347-1, EN61347-2-13
FCC, 47CFR Part 15	ANSI C63.4:2009 Class B (consumer limit)
EN61000-3-2	Harmonic Current Emissions Class C

### LED DRIVER OUTPUT WINDOW

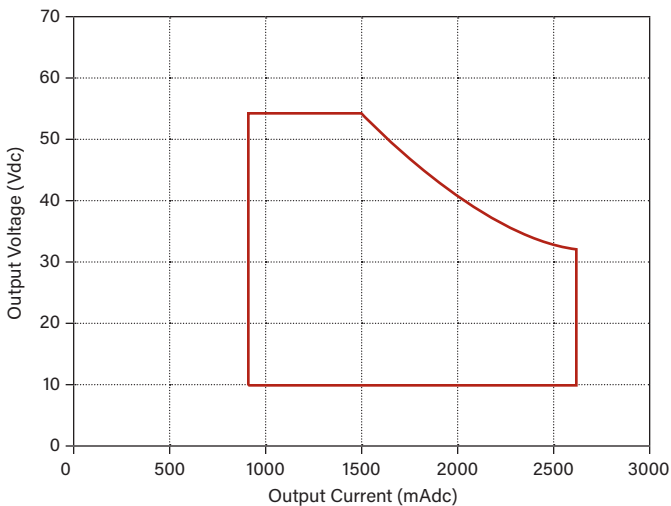

Note: driver is in constant power mode from 1500mA to 2600mA.

### ORDERING INFORMATION

ORDER CODE	PACKAGING STYLE	PACK QUANTITY	ITEM STATUS
KTLD-85-UV-SC2600-56-VDIM-U4 /USB	Carton Pack	20	Quick Ship

### CATALOG NUMBER BREAKDOWN

# KTLD-85-UV-SC2600-56-VDIM-U4 /USB

1

2

3

4

5

6

7

8

9

1 Keystone Technologies LED Driver

2 Max. Output Wattage

3 120-277V Input

4 Smart Current

5 Max. Output Current

6 Max. Output Voltage

7 0-10V Dimming

8 Case Style

9 USB