

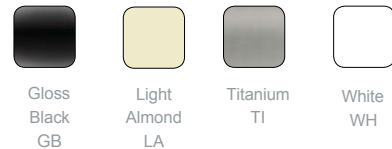

## System Features and Benefits

- Up to four sources per multi-source system
- Up to eight zones per multi-source system, with ability to expand
- Whole house control via universal remote and keypad
- High performance and standard systems
- Up to two local source inputs per keypad with Studio series
- Local source selectable via keypads
- Elegant, contemporary design
- Efficient installation via Cat 5 wiring

### COLORS



## RELATED PRODUCTS



AU5008-XX  
lyriQ Local Source  
Input



AU5009-XX  
lyriQ Keypad



AU5010-XX  
lyriQ High Performance  
Keypad



AU5544-XX  
lyriQ Multi-Source, Four-Zone Kit

## WIRING DIAGRAM

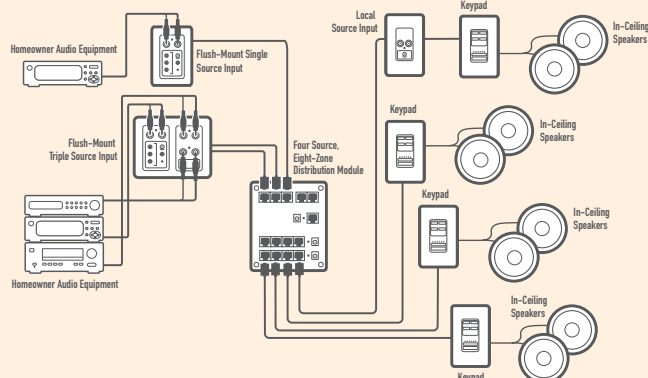





### INSTALLATION AT-A-GLANCE lyriQ MULTI-SOURCE AUDIO SYSTEM

1. Run a single Cat 5 cable and 16/4 speaker wire to each location where a keypad will be installed.
2. Install each keypad in a standard single gang box and connect a pair of speakers to the keypad.
3. Install the multi-source distribution module in the On-Q enclosure and connect it to the keypads.
4. Run a Cat 5 cable from the module to each location where a flush-mount source input will be installed.
5. Install the flush mount inputs in standard single or double gang boxes and connect the Cat 5.
6. Connect the source to the input.



## lyriQ SOURCE INPUTS

PRODUCT	PART #	DESCRIPTION	DIMENSIONS
<b>lyriQ Local Source Input in Studio Design</b> 	<b>AU5008-GB</b> <b>AU5008-LA</b> <b>AU5008-TI</b> <b>AU5008-WH</b>	<p>The lyriQ Local Source Input enables users to plug in devices like personal audio players locally for in-room entertainment. It includes a convenient RJ45 connection and adjustable gain control. Up to two local source inputs can be installed per zone, and it can be selected from the studio keypad or the On-Q remote.</p> <p><b>Includes Studio Wall Plate.</b></p>	4.2" H x 1.65" W
<b>lyriQ Flush Mount Triple Source Input</b> 	<b>AU1011-BK</b> <b>AU1011-LA</b> <b>AU1011-WH</b>	<p>The lyriQ Flush Mount Triple Source Input connects to the Four-Source, Eight-Zone Module to distribute three audio sources throughout the home. It features two RJ45 connections, adjustable gain control for each input, three IR emitter ports and one IR target port. Pair with the lyriQ Single Source Input in flush-mount or standard versions (AU1004 or F7398).</p> <p><b>Wall plate not included.</b></p>	4.2" H x 3.3" W
<b>lyriQ Flush Mount Single Source Input</b> 	<b>AU1004-BK</b> <b>AU1004-LA</b> <b>AU1004-WH</b>	<p>The lyriQ Flush Mount Single Source Input connects to a lyriQ distribution module to distribute one audio source throughout the home. It features an RJ45 connection, adjustable gain control, an IR emitter port and an IR target port.</p> <p><b>Wall plate not included.</b></p>	4.2" H x 1.65" W
<b>lyriQ Triple Source Input</b> 	<b>F7428</b>	<p>The lyriQ Triple Source Input connects to the Four-Source, Eight-Zone Module to distribute three audio sources throughout the home. It features two RJ45 connections, adjustable gain control for each input, three IR emitter ports and one IR target port. Pair with the lyriQ Single Source Input in flush-mount or standard versions (AU1004 or F7398).</p>	2.45" H x 4.5" W x 1.25" D
<b>lyriQ Single Source Input</b> 	<b>F7398</b>	<p>The lyriQ Single Source Input connects to a lyriQ distribution module to distribute one audio source throughout the home. It features an RJ45 connection, adjustable gain control, an IR emitter port and an IR target port.</p>	2.45" H x 4.5" W x 1.25" D

## COLOR OPTIONS

