



Catalog Number
Notes
Type

Contractor Select™ CPANL™ LED Switchable Lumen Panel

The CPANL LED switchable lumen flat panel provides a low profile, low-glare, uniform source ambient light solution. It includes two 3-level switches to easily and reliably adjust lumens and color temperature in the field making it ideal for a broad range of applications including offices, schools and hospitality spaces.

FEATURES:

- Up to 50% more lumens than standard panels
- Integral driver allows multiple mounting methods
- Two switches allow for easy field adjustment

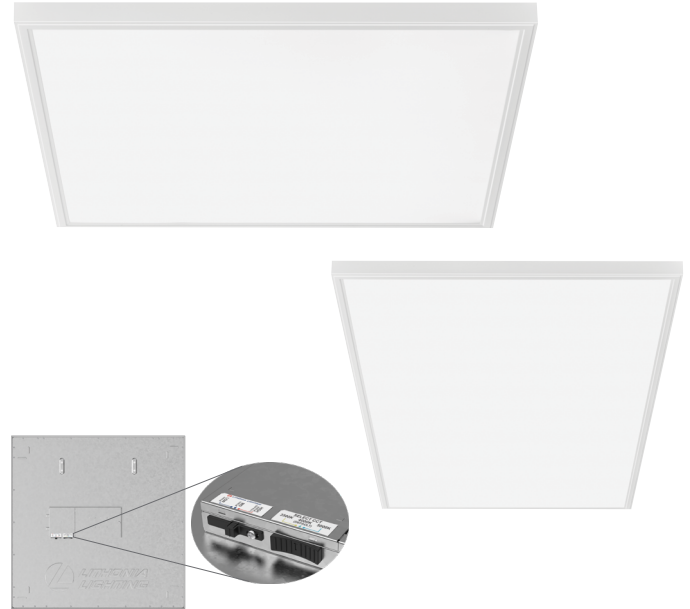

Description	UPC	Description	Nominal Lumens	Color Temperature	CRI	Voltage	Nominal Wattage	Pallet QTY
CPANL 1X4 ALO1 SWW7 M4	00194995124930	1x4 Fully Switchable Flat Panel	2400/3300/ 4400	35/ 40 /50K	>80	MVOLT (120-277)	22/31/ 41	56
CPANL 2X2 ALO1 SWW7 M4	00194995124923	2x2 Fully Switchable Flat Panel	2400/3300/ 4400	35/ 40 /50K	>80	MVOLT (120-277)	22/31/ 41	56
CPANL 2X4 ALO6 SWW7 M2	00194995124916	2x4 Fully Switchable Flat Panel	4000/5000/ 6000	35/ 40 /50K	>80	MVOLT (120-277)	36/45/ 55	28

More configurations are available. [Click here](#) or visit www.acuitybrands.com and search for CPANL

* Bolded lumen, color temperature and wattage designates default switch setting.

Accessories: Order as separate catalog number.	
ILBLP CP10 HE SD A	IOTA emergency constant power battery pack field installation kit (Certified in CA Title 20 MAEDBS) ¹
ELA PSDMT	External mounting tray to secure emergency battery to building structure, not required, battery can be mounted to fixture
DCMK 14	Direct Ceiling Mount Kit for 1x4 CPANL
DCMK 224	Direct Ceiling Mount Kit for 2x4 and 2x2 CPANL
1X4SMKSH	Surface Mount Kit 1X4, Shallow Depth
2X2SMKSH	Surface Mount Kit 2'x2', Shallow Depth
2X4SMKSH	Surface Mount Kit 2'x4', Shallow Depth
PAC 2DNF 36	Panel Air Craft Kit, 2 cables with Y splitter, No Power Feed, 36 inches
PAC 2DF 36	Panel Air Craft Kit, 2 cables with Y splitter, with Power Feed, 36 inches
PAC 2DNF 72	Panel Air Craft Kit, 2 cables with Y splitter, No Power Feed, 72 inches
PAC 2DF 72	Panel Air Craft Kit, 2 cables with Y splitter, with Power Feed, 72 inches
PAC 4DNF 36	Panel Air Craft Kit, 4 cables, No Power Feed, 36 inches
PAC 4DF 36	Panel Air Craft Kit, 4 cables, with Power Feed, 36 inches
DGA14	Drywall grid adapter for 1X4 recessed fixture
DGA22	Drywall grid adapter for 2x2 recessed fixture.
DGA24	Drywall grid adapter for 2x4 recessed fixture.

Emergency Battery Delivered Lumens
Use the formula below to determine the delivered lumens in emergency mode
Delivered Lumens = 1.25 x P x LPW
P = Output power of emergency driver (10W for PS1055)
LPW = Lumen per watt rating of the luminaire.

NOTES

1. See [ILBLP CP10 HE SD A spec sheet](#) and [ELA-PSMKPSMKSD-PSDMT-PSRME remote mounting enclosure spec sheet here](#).



Switchable Table						
Size	Nomenclature	Lumen Setting	CCT	Lumen	Wattage	Efficacy
1x4	CPANL 1X4 AL01 SWW7 M4	Low Lumen	3500K	2645	21.6	122
			4000K	2712	20.9	130
			5000K	2637	21.4	123
		Medium Lumen	3500K	3599	30.7	117
			4000K	3754	29.4	128
			5000K	3595	30.4	118
		High Lumen	3500K	4597	40.5	114
			4000K	4881	38.7	126
			5000K	4596	40.1	115
2x2	CPANL 2X2 AL01 SWW7 M4	Low Lumen	3500K	2617	21.6	121
			4000K	2750	20.9	132
			5000K	2766	21.5	129
		Medium Lumen	3500K	3778	30.6	123
			4000K	3930	29.4	134
			5000K	3755	30.5	123
		High Lumen	3500K	4741	40.5	117
			4000K	5031	38.8	130
			5000K	4717	40.4	117
2x4	CPANL 2X4 AL06 SWW7 M2	Low Lumen	3500K	4363	35.7	122
			4000K	4450	34.4	129
			5000K	4358	35.4	123
		Medium Lumen	3500K	5354	45.1	119
			4000K	5509	43.3	127
			5000K	5351	44.8	119
		High Lumen	3500K	6343	55.1	115
			4000K	6579	52.7	125
			5000K	6353	54.7	116

* Bolded lumen, color temperature and wattage designates default switch setting.

CPANL MOUNTED WITH DCMK

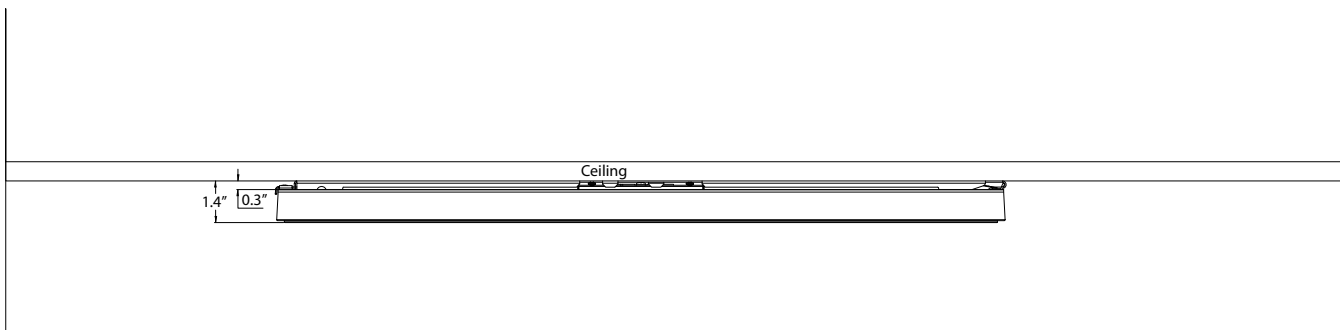



DCMK - DIRECT CEILING MOUNT KITS (Sold as a separate accessory, see accessories section on page 1)

DCMK 14

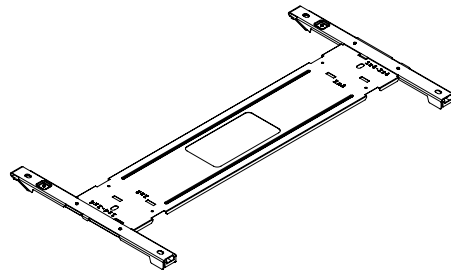
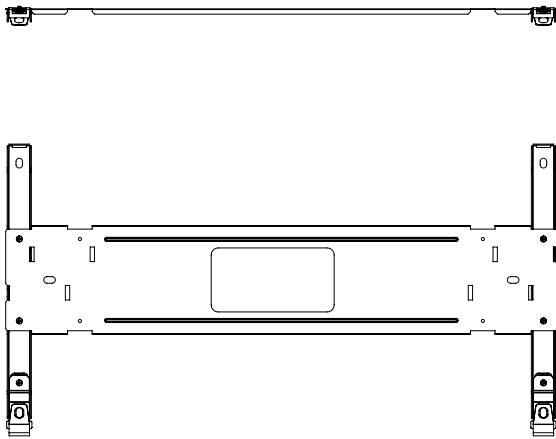

DCMK 224

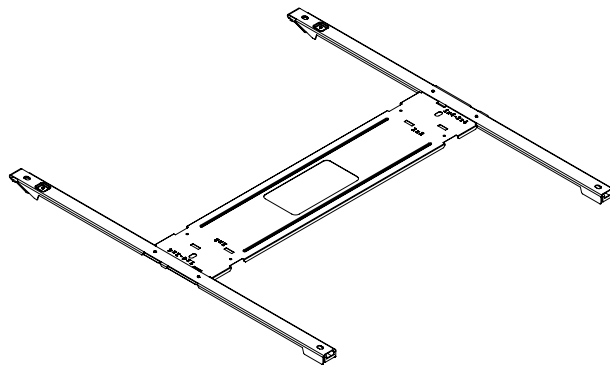
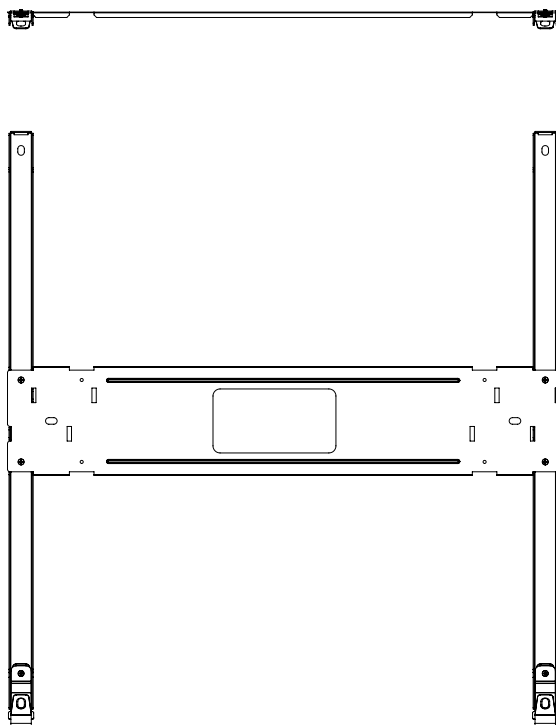



Specifications

INTENDED USE:

The CPANL Series LED is a low-glare, switchable-lumen, switchable color temperature panel featuring an internal driver. This reliable and rigid flat panel is visually comfortable and can be recessed, direct ceiling mounted, suspended or surface box mounted. Suitable for many applications such as schools, offices, retail, convenience stores, hospitals, healthcare facilities and other commercial spaces. **Certain airborne contaminants can diminish the integrity of acrylic and/or polycarbonate.** [Click here for Acrylic/Polycarbonate Compatibility table for suitable uses.](#)

CONSTRUCTION:

Built to last with an aluminum frame for strength and durability, the seamless frame prevents light leak in the corners. The satin white lens provides excellent shielding and fully luminous appearance. CPANL's low-profile design provides increased installation flexibility especially in restricted plenum spaces. The back plate includes integral T-bar clips for installation into 9/16" or 15/16" T-grid ceilings. Fixture may be direct ceiling mounted in a hard-ceiling with the DCMK bracket (see accessories section for more information). Fixture may be mounted and wired in continuous rows.

ELECTRICAL:

Long-life LEDs, coupled with a high-efficiency driver, provide superior illumination for extended service life. 70% LED lumen maintenance at 60,000 hours (L70/60,000). 0-10V dimming driver, dims to 10% and contains non-isolated dimming leads. Switch set to max high lumen output at the factory.

For optimal 0-10V dimming performance it is recommended that the luminaire remains at factory default high lumen setting.

LISTINGS:

CSA certified to meet US and Canadian standards. Intended for indoor use only. Product is not to be stored in non-climate controlled spaces. Damp location listed. IC rated. IP5X Rated. Rated for NSF/ANSI Standard 2 - Light Fixture for Splash Zone and Non Food Zone.

DesignLights Consortium® (DLC) qualified product. Not all versions of this product may be DLC qualified. Please check the DLC Qualified Products List at www.designlights.org/QPL to confirm which versions are qualified.

WARRANTY:

5-year limited warranty. This is the only warranty provided and no other statements in this specification sheet create any warranty of any kind. All other express and implied warranties are disclaimed. Complete warranty terms located at:

www.acuitybrands.com/support/warranty/terms-and-conditions

Note: Actual performance may differ as a result of end-user environment and application. All values are design or typical values, measured under laboratory conditions at 25 °C. Specifications subject to change without notice.

Dimensions

All dimensions are inches (centimeters) unless otherwise indicated.

Length: 47.8 (121.4) Weight:
 Width: 23.8 (60.4) Unit: 17.8lbs
 Depth: 1.1 (2.7) Unit Carton: 19.7lbs
 Master Carton: 43.3lbs

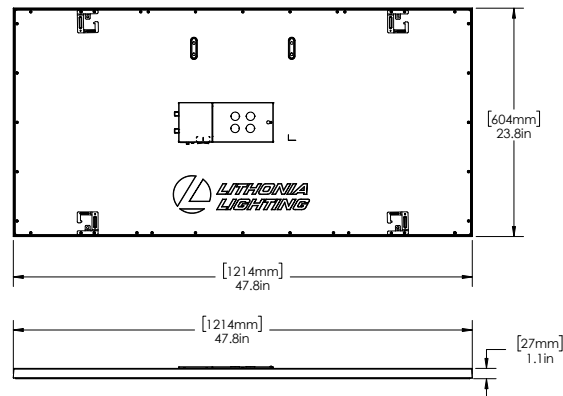

Length: 23.8 (60.4)
 Width: 23.8 (60.4)
 Depth: 1.1 (2.7)
 Weight:
 Unit: 9.0lbs
 Unit Carton: 10.0lbs
 Master Carton: 41.9lbs

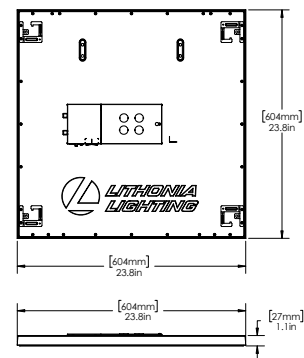

Length: 11.9(30.2) Weight:
 Width: 47.7 (121.12) Unit: 9.3lbs
 Depth: 1.1 (2.7) Unit Carton: 10.3lbs
 Master Carton: 43.2lbs

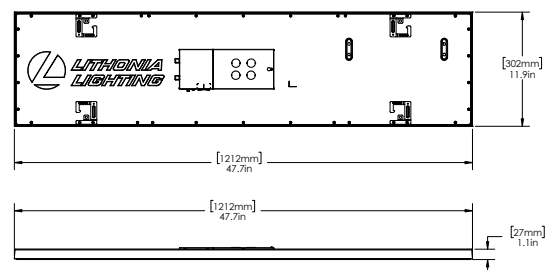



Catalog Number
Notes
Type

Contractor Select™ CPANL™ LED Switchable Lumen Panel

The CPANL LED switchable lumen flat panel provides a low profile, low-glare, uniform source ambient light solution. It includes two 3-level switches to easily and reliably adjust lumens and color temperature in the field making it ideal for a broad range of applications including offices, schools and hospitality spaces.

FEATURES:

- Up to 50% more lumens than standard panels
- Integral driver allows multiple mounting methods
- Two switches allow for easy field adjustment

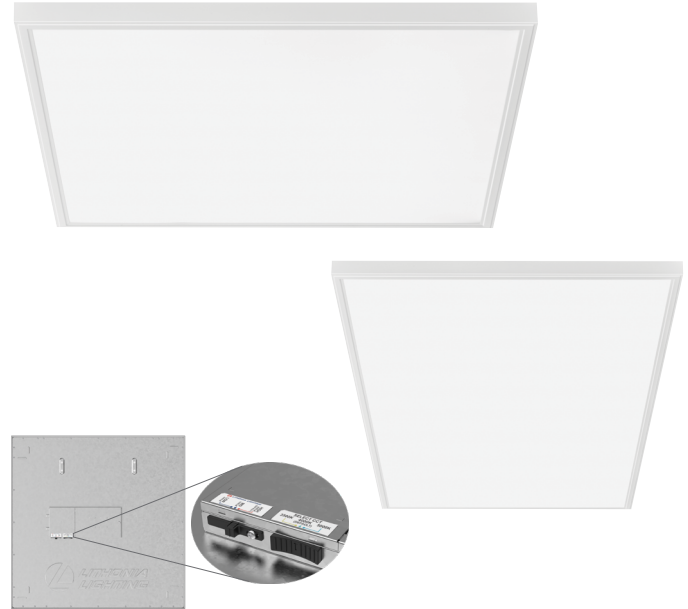

Description	UPC	Description	Nominal Lumens	Color Temperature	CRI	Voltage	Nominal Wattage	Pallet QTY
CPANL 1X4 ALO1 SWW7 M4	00194995124930	1x4 Fully Switchable Flat Panel	2400/3300/ 4400	35/ 40 /50K	>80	MVOLT (120-277)	22/31/ 41	56
CPANL 2X2 ALO1 SWW7 M4	00194995124923	2x2 Fully Switchable Flat Panel	2400/3300/ 4400	35/ 40 /50K	>80	MVOLT (120-277)	22/31/ 41	56
CPANL 2X4 ALO6 SWW7 M2	00194995124916	2x4 Fully Switchable Flat Panel	4000/5000/ 6000	35/ 40 /50K	>80	MVOLT (120-277)	36/45/ 55	28

More configurations are available. [Click here](#) or visit www.acuitybrands.com and search for CPANL

* Bolded lumen, color temperature and wattage designates default switch setting.

Accessories: Order as separate catalog number.	
ILBLP CP10 HE SD A	IOTA emergency constant power battery pack field installation kit (Certified in CA Title 20 MAEDBS) ¹
ELA PSDMT	External mounting tray to secure emergency battery to building structure, not required, battery can be mounted to fixture
DCMK 14	Direct Ceiling Mount Kit for 1x4 CPANL
DCMK 224	Direct Ceiling Mount Kit for 2x4 and 2x2 CPANL
1X4SMKSH	Surface Mount Kit 1X4, Shallow Depth
2X2SMKSH	Surface Mount Kit 2'x2', Shallow Depth
2X4SMKSH	Surface Mount Kit 2'x4', Shallow Depth
PAC 2DNF 36	Panel Air Craft Kit, 2 cables with Y splitter, No Power Feed, 36 inches
PAC 2DF 36	Panel Air Craft Kit, 2 cables with Y splitter, with Power Feed, 36 inches
PAC 2DNF 72	Panel Air Craft Kit, 2 cables with Y splitter, No Power Feed, 72 inches
PAC 2DF 72	Panel Air Craft Kit, 2 cables with Y splitter, with Power Feed, 72 inches
PAC 4DNF 36	Panel Air Craft Kit, 4 cables, No Power Feed, 36 inches
PAC 4DF 36	Panel Air Craft Kit, 4 cables, with Power Feed, 36 inches
DGA14	Drywall grid adapter for 1X4 recessed fixture
DGA22	Drywall grid adapter for 2x2 recessed fixture.
DGA24	Drywall grid adapter for 2x4 recessed fixture.

Emergency Battery Delivered Lumens
Use the formula below to determine the delivered lumens in emergency mode
Delivered Lumens = 1.25 x P x LPW
P = Output power of emergency driver (10W for PS1055)
LPW = Lumen per watt rating of the luminaire.

NOTES

1. See [ILBLP CP10 HE SD A spec sheet](#) and [ELA-PSMKPSMKSD-PSDMT-PSRME remote mounting enclosure spec sheet here](#).



Switchable Table						
Size	Nomenclature	Lumen Setting	CCT	Lumen	Wattage	Efficacy
1x4	CPANL 1X4 AL01 SWW7 M4	Low Lumen	3500K	2645	21.6	122
			4000K	2712	20.9	130
			5000K	2637	21.4	123
		Medium Lumen	3500K	3599	30.7	117
			4000K	3754	29.4	128
			5000K	3595	30.4	118
		High Lumen	3500K	4597	40.5	114
			4000K	4881	38.7	126
			5000K	4596	40.1	115
2x2	CPANL 2X2 AL01 SWW7 M4	Low Lumen	3500K	2617	21.6	121
			4000K	2750	20.9	132
			5000K	2766	21.5	129
		Medium Lumen	3500K	3778	30.6	123
			4000K	3930	29.4	134
			5000K	3755	30.5	123
		High Lumen	3500K	4741	40.5	117
			4000K	5031	38.8	130
			5000K	4717	40.4	117
2x4	CPANL 2X4 AL06 SWW7 M2	Low Lumen	3500K	4363	35.7	122
			4000K	4450	34.4	129
			5000K	4358	35.4	123
		Medium Lumen	3500K	5354	45.1	119
			4000K	5509	43.3	127
			5000K	5351	44.8	119
		High Lumen	3500K	6343	55.1	115
			4000K	6579	52.7	125
			5000K	6353	54.7	116

* Bolded lumen, color temperature and wattage designates default switch setting.

CPANL MOUNTED WITH DCMK

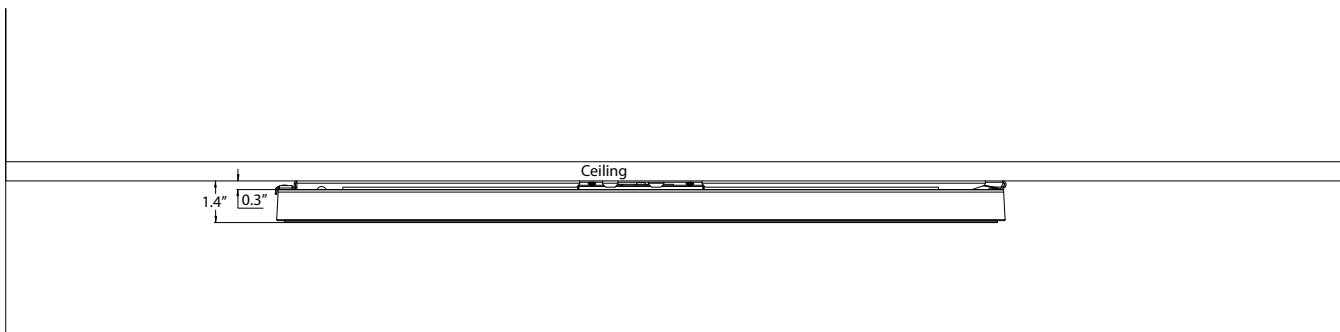



DCMK - DIRECT CEILING MOUNT KITS (Sold as a separate accessory, see accessories section on page 1)

DCMK 14

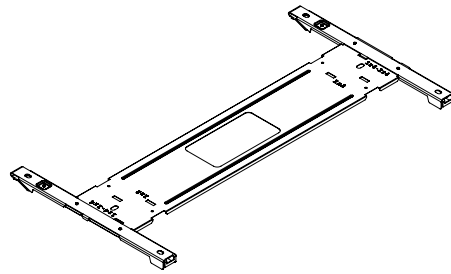
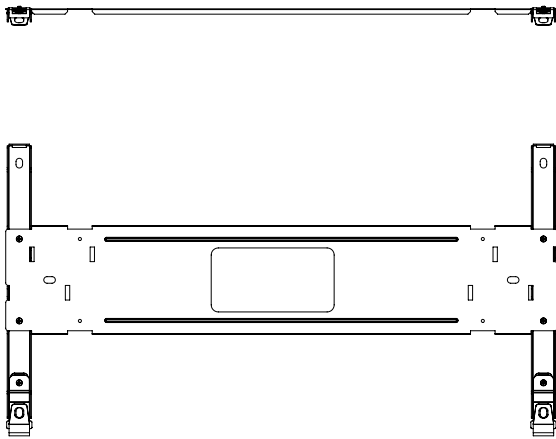

DCMK 224

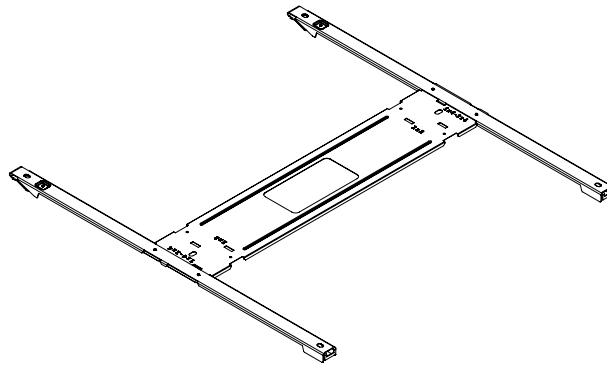
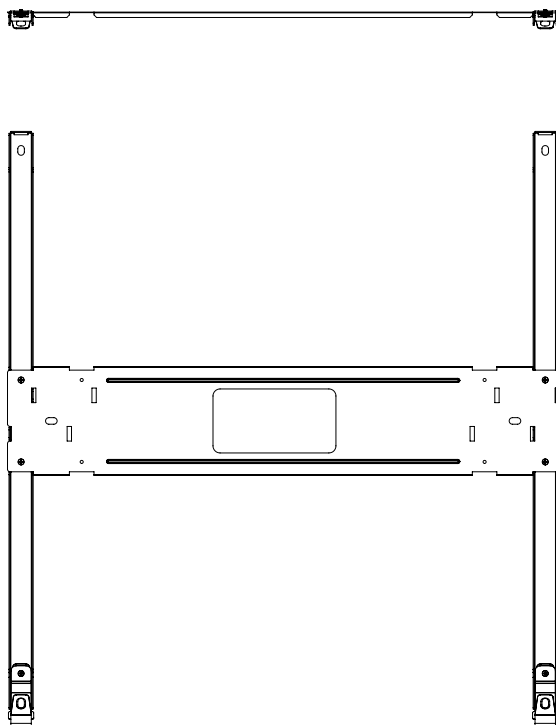



Specifications

INTENDED USE:

The CPANL Series LED is a low-glare, switchable-lumen, switchable color temperature panel featuring an internal driver. This reliable and rigid flat panel is visually comfortable and can be recessed, direct ceiling mounted, suspended or surface box mounted. Suitable for many applications such as schools, offices, retail, convenience stores, hospitals, healthcare facilities and other commercial spaces. **Certain airborne contaminants can diminish the integrity of acrylic and/or polycarbonate.** [Click here for Acrylic/Polycarbonate Compatibility table for suitable uses.](#)

CONSTRUCTION:

Built to last with an aluminum frame for strength and durability, the seamless frame prevents light leak in the corners. The satin white lens provides excellent shielding and fully luminous appearance. CPANL's low-profile design provides increased installation flexibility especially in restricted plenum spaces. The back plate includes integral T-bar clips for installation into 9/16" or 15/16" T-grid ceilings. Fixture may be direct ceiling mounted in a hard-ceiling with the DCMK bracket (see accessories section for more information). Fixture may be mounted and wired in continuous rows.

ELECTRICAL:

Long-life LEDs, coupled with a high-efficiency driver, provide superior illumination for extended service life. 70% LED lumen maintenance at 60,000 hours (L70/60,000). 0-10V dimming driver, dims to 10% and contains non-isolated dimming leads. Switch set to max high lumen output at the factory.

For optimal 0-10V dimming performance it is recommended that the luminaire remains at factory default high lumen setting.

LISTINGS:

CSA certified to meet US and Canadian standards. Intended for indoor use only. Product is not to be stored in non-climate controlled spaces. Damp location listed. IC rated. IP5X Rated. Rated for NSF/ANSI Standard 2 - Light Fixture for Splash Zone and Non Food Zone.

DesignLights Consortium® (DLC) qualified product. Not all versions of this product may be DLC qualified. Please check the DLC Qualified Products List at www.designlights.org/QPL to confirm which versions are qualified.

WARRANTY:

5-year limited warranty. This is the only warranty provided and no other statements in this specification sheet create any warranty of any kind. All other express and implied warranties are disclaimed. Complete warranty terms located at:

www.acuitybrands.com/support/warranty/terms-and-conditions

Note: Actual performance may differ as a result of end-user environment and application. All values are design or typical values, measured under laboratory conditions at 25 °C. Specifications subject to change without notice.

Dimensions

All dimensions are inches (centimeters) unless otherwise indicated.

Length: 47.8 (121.4) Weight:
Width: 23.8 (60.4) Unit: 17.8lbs
Depth: 1.1 (2.7) Unit Carton: 19.7lbs
Master Carton: 43.3lbs

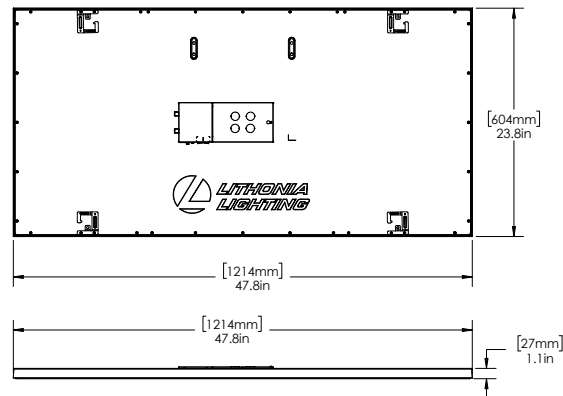

Length: 23.8 (60.4)
Width: 23.8 (60.4)
Depth: 1.1 (2.7)
Weight:
Unit: 9.0lbs
Unit Carton: 10.0lbs
Master Carton: 41.9lbs

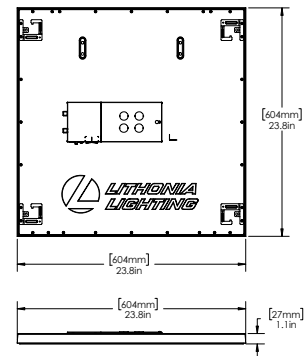

Length: 11.9(30.2) Weight:
Width: 47.7 (121.12) Unit: 9.3lbs
Depth: 1.1 (2.7) Unit Carton: 10.3lbs
Master Carton: 43.2lbs

