

2

1

NOTES:

- 1. UL CATEGORIES: UL985, UL1863
- 2. COATING: POWDER
- 3. STEEL GAUGE: 20
- 4. INSTRUCTION SHEET INCLUDED
- 5. CABLE GUARD INSERT INCLUDED

B

B

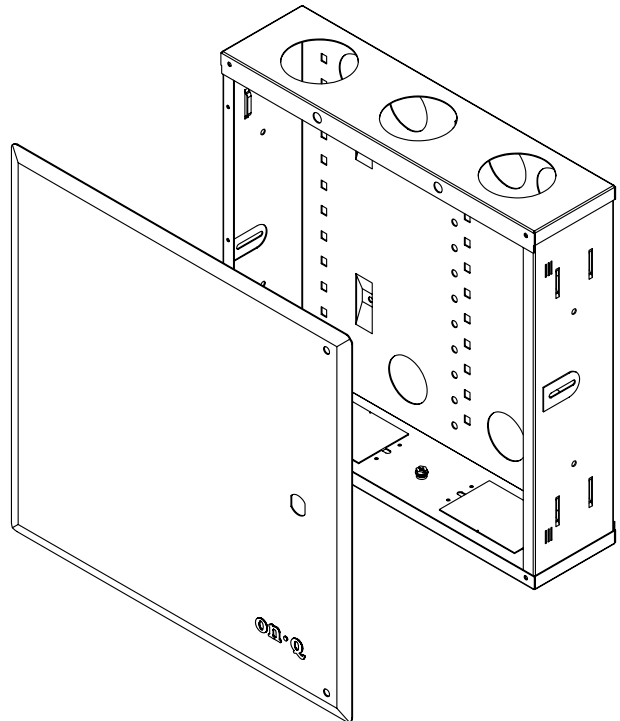
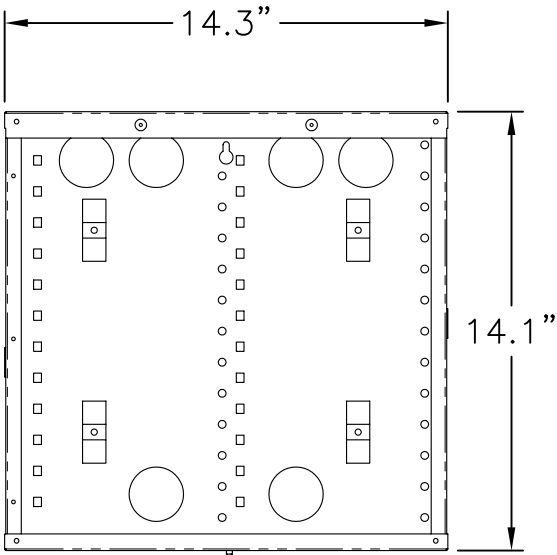
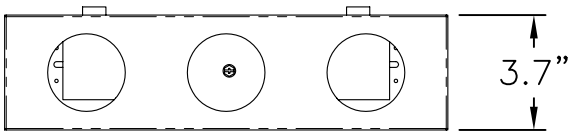

A

A

PROPRIETARY AND CONFIDENTIAL
 THE INFORMATION CONTAINED
 IN THIS DRAWING IS THE SOLE
 PROPERTY OF On-Q/LEGRAND.
 ANY REPRODUCTION IN PART OR
 AS A WHOLE WITHOUT THE WRITTEN
 PERMISSION OF On-Q/LEGRAND
 IS PROHIBITED. DRAWING IS SUBJECT
 TO CHANGE WITHOUT NOTICE.

on·Q

legrand

P.O. Box 60907
 Middletown, PA 17106-0907
 1-800-321-2343

TITLE:

**14 IN ENCLOSURE WITH
 HINGED COVER AND LOCK**

SIZE	DWG NO	FILE NAME	CUST REV
A	EN1450	CD-EN1450	1
REVISED DATE	SCALE	SHEET	
11/01/07	NONE	1 OF 1	

2

1