



INSTALLATION INSTRUCTIONS FOR RECESSED EDGE-LIT LED EXIT SIGN

IMPORTANT SAFEGUARDS

WHEN USING ELECTRICAL EQUIPMENT BASIC SAFETY PRECAUTIONS SHOULD ALWAYS BE FOLLOWED, INCLUDING THE FOLLOWING:

READ AND FOLLOW ALL SAFETY INSTRUCTIONS

- ⚠ **WARNING: FAILURE TO FOLLOW THESE INSTRUCTIONS AND WARNINGS MAY RESULT IN DEATH, SERIOUS INJURY OR SIGNIFICANT PROPERTY DAMAGE** - For your protection, read and follow these warnings and instructions carefully before installing or maintaining this equipment. These instructions do not attempt to cover all installation and maintenance situations.
- ⚠ **WARNING: RISK OF ELECTRIC SHOCK - NEVER CONNECT TO, DISCONNECT FROM, OR SERVICE WHILE EQUIPMENT IS ENERGIZED.**
- ⚠ **WARNING: RISK OF FIRE** - Keep combustible material away from hot parts. Observe lamp manufacturer's warnings, recommendations and restrictions on lamp operation and maintenance. Make sure lamps are correctly installed.
- ⚠ **WARNING: DO NOT USE ABRASIVE MATERIALS OR OTHER SOLVENTS. USE OF THESE SUBSTANCES MAY DAMAGE FIXTURE, WHICH MAY RESULT IN PERSONAL INJURY.**
- ⚠ **WARNING: RISK OF PERSONAL INJURY** - This product may have sharp edges. Wear gloves to prevent cuts or abrasions when removing from carton, handling, installing and maintaining this product.
 - Before wiring to power supply, turn off electricity at fuse or circuit breaker.
 - Disconnect A.C. power and unplug battery before servicing.
 - Consult your local building code for approved wiring and installation.
 - UL Damp location listed standard. (0°C- 50°C)
 - Do not let power supply cord touch hot surfaces.
 - Do not mount near gas or electric heater.
 - Do not install a damaged fixture.
 - This product must be installed in accordance with the applicable installation codes and ordinances.
 - All service shall be performed by qualified service personnel. This product must be installed and maintained in accordance with the applicable installation codes by a person familiar with the construction operation of the product and the hazards involved.
 - Equipment should be mounted in locations and at heights where it will not readily be subjected to tampering by unauthorized personnel.
 - The use of accessory equipment not recommended by the manufacturer may cause an unsafe condition.
 - Do not use this equipment for other than intended use.

**SAVE THESE INSTRUCTIONS
AND DELIVER TO OWNER AFTER INSTALLATION**

INSTALLATION

CAUTION: TURN OFF AC POWER TO CIRCUIT BEFORE BEGINNING INSTALLATION.

NEW WORK INSTALLATION [for optional remodel installation, see page 4]

1. See Figure 1 before beginning installation.
2. Position metal housing and bar hangers between ceiling or wall joists. Make sure bar hangers are in the correct position to be mounted. Position metal housing temporarily by hammering nail-in tabs on bar hangers, then secure permanently with nails or screw. Bar hangers should be level with bottom of joists (Figure 2).
3. Adjust height of metal housing so that the bottom of the housing is just above the ceiling or wall (Figure 3).
4. Make proper electrical connections at the J-box in the metal housing (Figures 4 & 5). If using 120 VAC, connect the black and white leads to the building power. If using 277 VAC, connect red and white leads to the building power.

CAUTION: The unused lead must be insulated with the remaining provided wire nut.

5. Determine directional chevron requirements. Follow instructions on provided templates to apply the required chevron(s). See also Figure 6.
6. Attach safety chain to holes in trim plate assembly. Snap together the quick-connector harness to connect the LED board to the transformer.
7. Connect the battery (EL models) after continuous AC power can be provided to the unit.
8. Secure the trim plate assembly using the provided screws.

WIRING DIAGRAMS:

BATTERY BACKUP(EL Model)

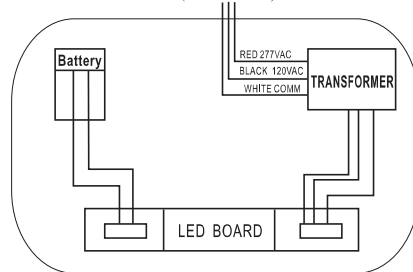

AC ONLY

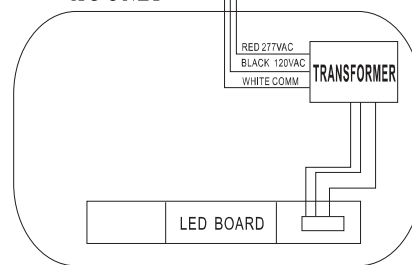

INSPECTION AND MAINTENANCE

NOTE: On emergency (EL) models, the battery may be supplied with less than a full charge. After continuous AC power is provided, allow 24 hours for full charge and before initial testing.

LAMP OR BATTERY REPLACEMENT: Use only the replacement part specified on the product (UL) label. Use of any other light source or battery may result in transformer damage or unsafe conditions.

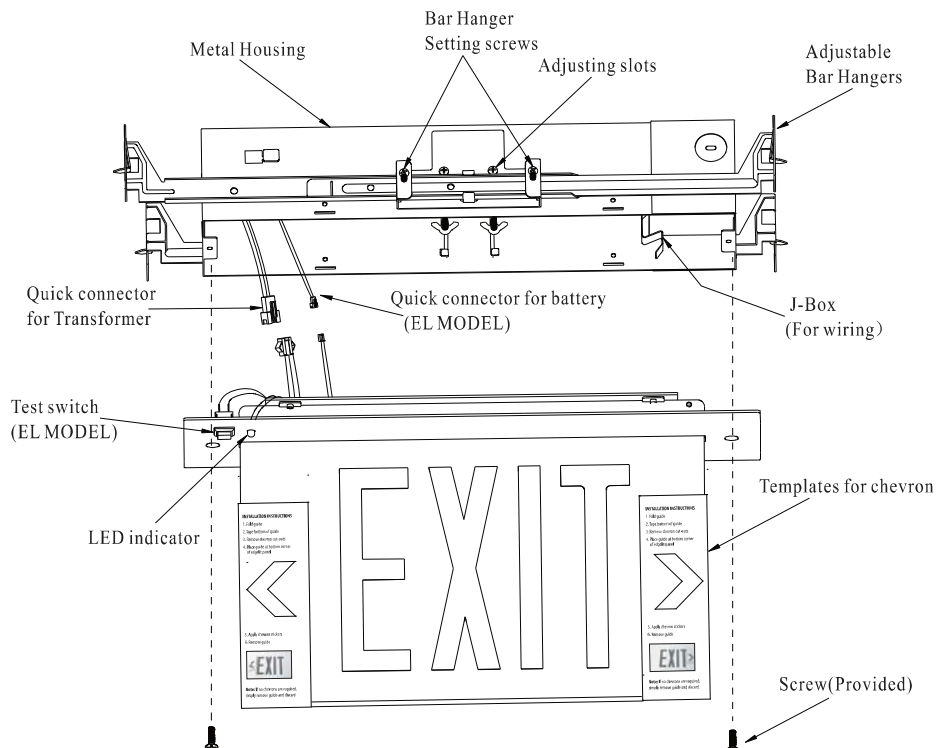

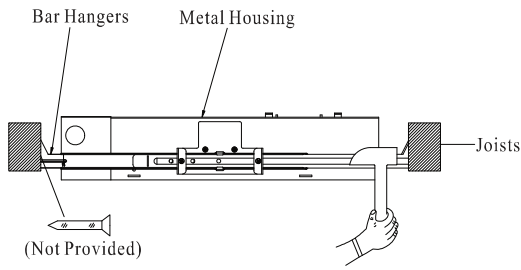

Fig. 2

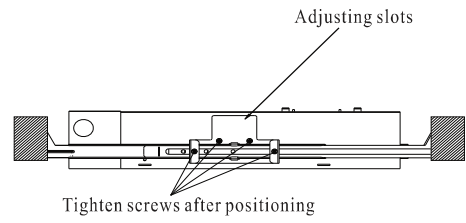

Fig. 3

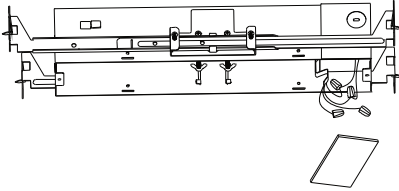

Fig. 4

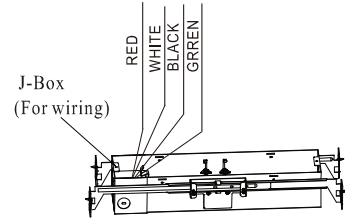

Fig. 5

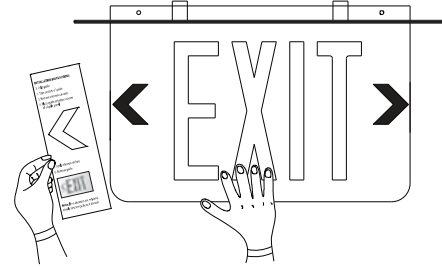
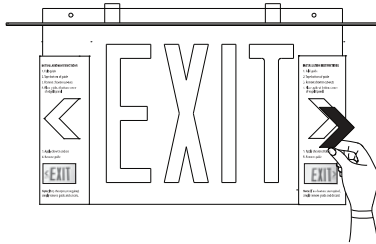

Fig. 6

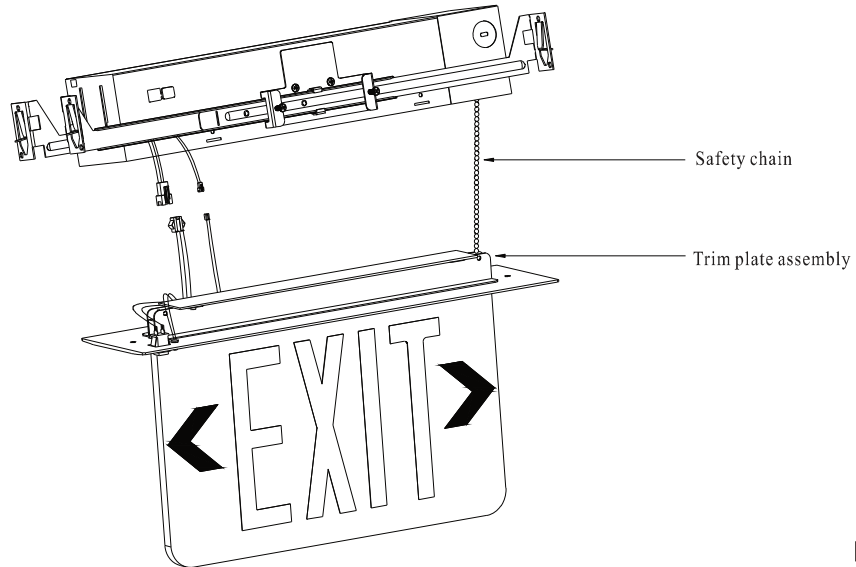

Fig. 7

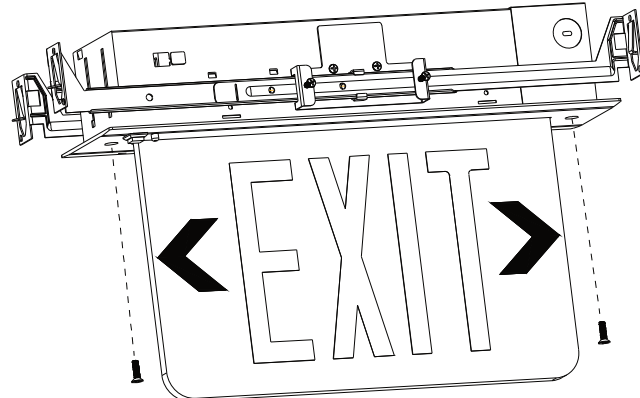

Fig. 8

OPTIONAL REMODEL BRACKET-MOUNT INSTALLATION INSTRUCTIONS

NOTE:

The unit comes with hardware (placed in a separate pouch) for drywall remodel installation. The pouch should contain a set of (4) metal brackets, (4) small screws, (4) nuts, (4) long screws, and (4) screw holders.

1. Remove all mounting hanger bars.
2. Slide the screw holders into the holes on the unit's housing as shown in Figure 1.
3. Secure the screw holders with the small screws provided (refer to Figures 2 and 3).
4. Position the metal brackets beneath the screw holders and inset the long screws (refer to Figure 4). Tighten the screw until the head reaches the screw holder (refer to Figure 5).
CAUTION: DO NOT TIGHTEN THE SCREWS TO THE POINT WHERE THE BRACKETS START TO EXPAND OUTWARD.
5. Cut a hole in the ceiling or wall using the provided template. Slide the housing through the ceiling or wall.
6. Once the housing is inside the ceiling or wall, start tightening the long screws. At this point the brackets start to bow out. (Figure 6).
7. Follow steps 4-8 from the "Recessed Mounting Instructions" (from page 2) to finish the installation.

RECESSED BOX SIDE HANGER BAR-MOUNTING INSTRUCTION

1. Knock-out the slot at the end of recessed box. (refer to Figure 8).
2. Un-tight the Wing Nut and remove both of the Hanger Bars and washers. (refer to Figure 9).
3. Install the Hang Bar to the side of the recessed box and tight up the Wing Nut with the washer. (refer to Figure 10).
4. Follow steps 1-8 from the "Installation Instructions" (page 2).

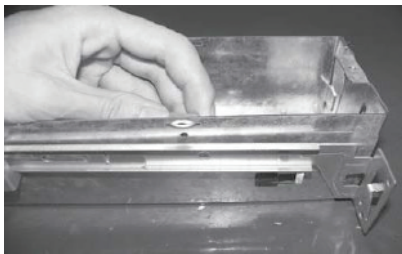

Figure 1



Figure 2

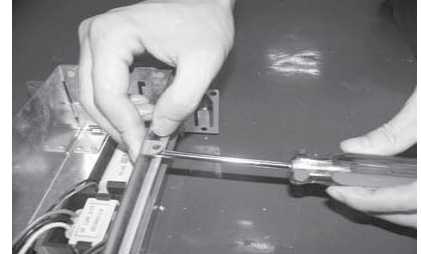

Figure 3

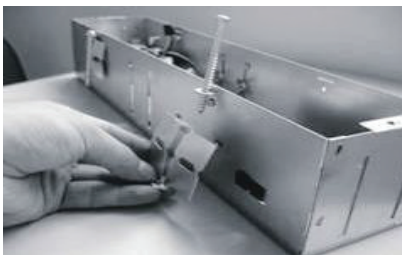

Figure 4

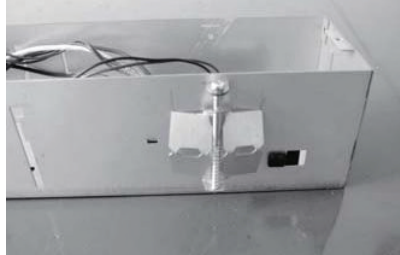

Figure 5



Figure 6



Figure 7



Figure 8



Figure 9

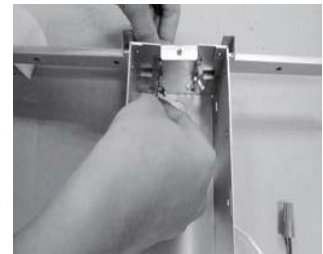

Figure 10