

GANGABLE FLOOR BOX

FOR NEW CONCRETE



WITH PLASTIC & METAL COVER KITS

Arlington®



INTERLOCKING • UL LISTED • FOR COMMERCIAL USE

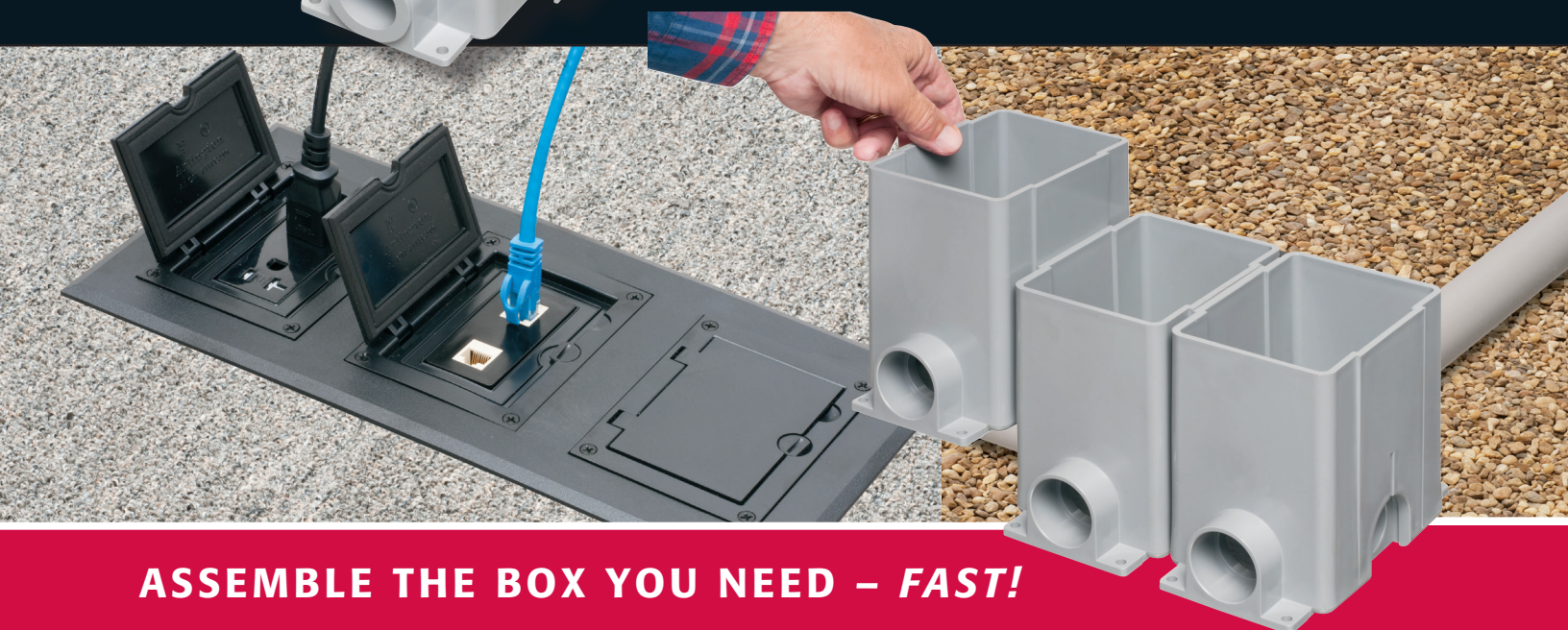

ASSEMBLE THE BOX YOU NEED - FAST!

UL LISTED

GANGABLE FLOOR BOX

ECONOMICAL • CONVENIENT RECEPTACLE INSTALLATION

Arlington manufactures a complete line of floor box kits, boxes, covers and accessories for new concrete – and other applications.

The UL Listed **GANGABLE FLOOR BOXES** and **COVER/FRAME KITS** featured here are designed for commercial installations. Available with 1-1/4" or 2" conduit hubs, our gangable boxes give installers an economical, convenient way to add receptacles in **new concrete** pours.

You can use the interlocking single gang box as shipped, or join them together to build the two- or three-gang box you need. You decide. Then buy the economical brass or nickel-plated zinc, or plastic cover/frame kit to fit. *All kits, except those on page 8, include a 20A decorator-style receptacle and low voltage insert.*

The gasketed frame mounts to the box. The cover then mounts to the frame where it protects the devices against water intrusion when not in use.

- Openings for OPTIONAL 1/4-20 screws that position, level and raise box so concrete flows beneath.

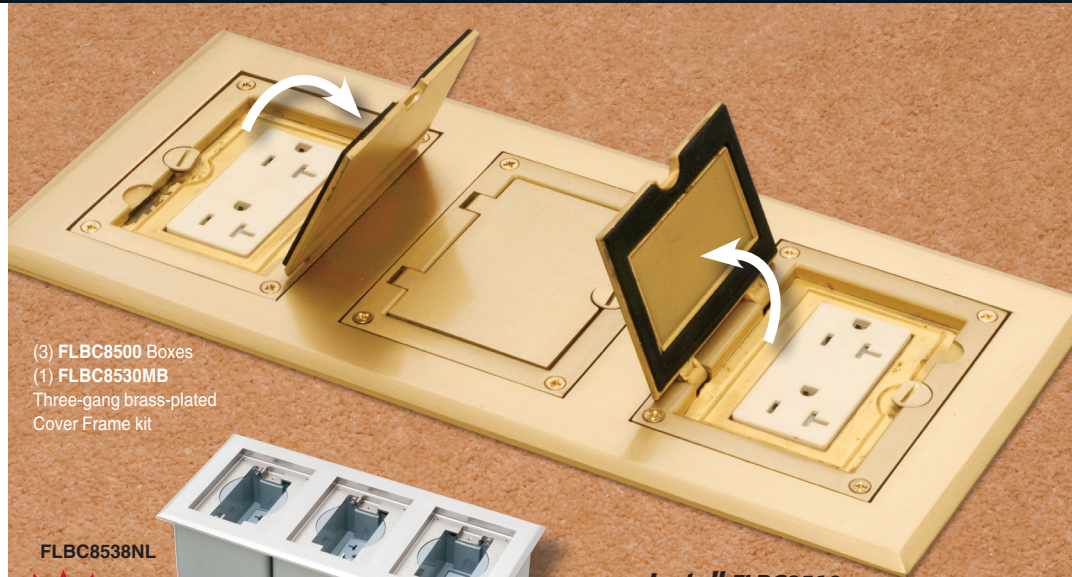

(3) FLBC8500 Boxes
(1) FLBC8530MB
Three-gang brass-plated
Cover Frame kit



FLBC8538NL

NEW COVER KITS
Recessed, pg 6-7
w Furniture Feed
inserts, on Back

FLBC8528NL
RECESSED cover kit

Install FLBC8510, FLBC8520, FLBC8530 covers with hinge on either side.

Repositioning the Cover Hinge... EASY!



Remove Cover
(hinge on right)



Rotate cover



Reinstall cover



Hinge now on left

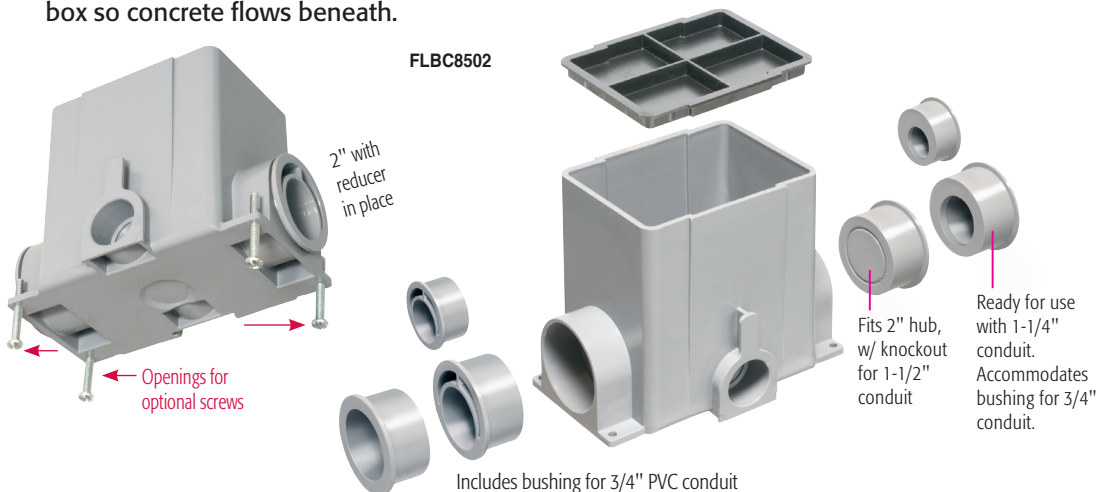

FLBC8502

2" with
reducer
in place

← Openings for
optional screws

Fits 2" hub,
w/ knockout
for 1-1/2"
conduit

Ready for use
with 1-1/4"
conduit.
Accommodates
bushing for 3/4"
conduit.

Includes bushing for 3/4" PVC conduit

800.233.4717 • www.aifittings.com • EMAIL sales@aifittings.com

FOR NEW CONCRETE

INTERLOCKING • EASY ASSEMBLY OF MULTIPLE-GANG BOXES

Connections on
opposing sides
lock boxes
securely together

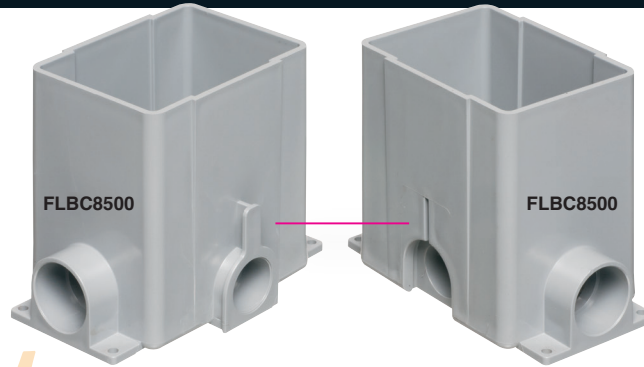

HERE'S HOW IT WORKS

Lock two single-gang boxes
together for a two-gang box.

Need a three-gang
box instead?
Add another box!

After building desired box,
attach cover frame (screws provided)

Install devices
(screws provided)

To install cover, insert gaskets
in both gangs, add covers

Both boxes include the hubs and plugs you'll need to complete most installations.

SINGLE GANG FLOOR BOX KIT

CATALOG NUMBER	UPC/DCI/NAED MFG. #018997	DESCRIPTION/ CONDUIT HUB SIZE	COLOR/ MATERIAL	UNIT PKG	STD PKG
FLBC8500	22950	Single gang Gangable Box kit with (2) built-in 1-1/4" hubs	Non-metallic, Gray	1	5
FLBC8502	22949	Single gang Gangable Box kit with (2) built-in 2" hubs	Non-metallic, Gray	1	5

FLBC8500 includes concrete box/mud cover, (2) 3/4" conduit bushings and (2) blank plugs* that fit the 1-1/4" hubs (*w/ knockout for 1" conduit) -- FLBC8502 includes concrete box/mud cover and (2) blank plugs* for the 2" hubs (*w/ knockout for 1-1/2" conduit). Also included are (2) conduit bushings ready for use with 1-1/4" conduit. These bushings accommodate the (2) supplied 3/4" conduit bushings.

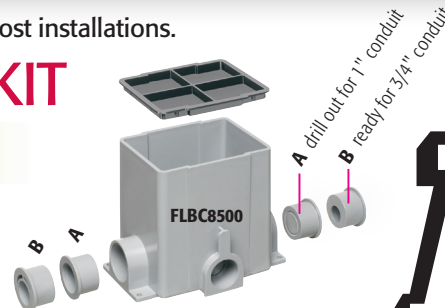

PLASTIC COVERS, 5 COLORS



RECTANGULAR NON-METALLIC BOX

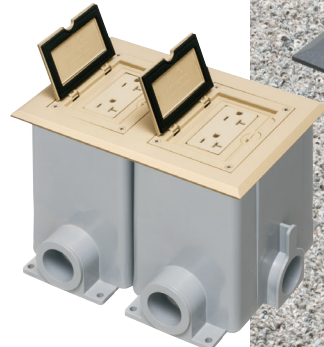

(2) FLBC8500 boxes

(1) FLBC8520LA Light Almond plastic cover/frame kit



(3) FLBC8500 boxes
(1) FLBC8530BL Black plastic cover/frame kit

Caramel

Patented

COVER KITS FOR FLBC8500, FLBC8502



FLBC8501BL



FLBC8501BR

CATALOG NUMBER	UPC/DCI/NAED MFG. #018997	DESCRIPTION	PLASTIC COVER COLOR	UNIT PKG	STD PKG
FLBC8501BL	22961	Single gang Flip Lid Cover	Black	1	10
FLBC8501BR	22962	Single gang Flip Lid Cover	Brown	1	10
FLBC8501GY	22963	Single gang Flip Lid Cover	Gray	1	10
FLBC8501LA	22974	Single gang Flip Lid Cover	Light Almond	1	10
FLBC8501CA	22973	Single gang Flip Lid Cover	Caramel	1	10

Includes PLASTIC single gang gasketed flip lid cover, (1) 20A decorator-style receptacle, (1) low voltage insert.

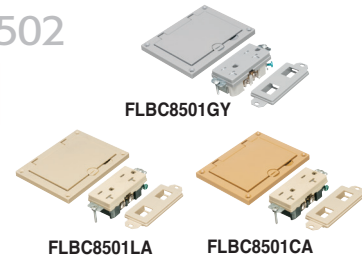

FLBC8501GY

FLBC8501LA

FLBC8501CA



FLBC8510BR

SINGLE GANG PLASTIC COVER / FRAME KITS

FLBC8510BL	22964	Single gang Frame	Black	1	1
FLBC8510BR	22965	Single gang Frame	Brown	1	1
FLBC8510GY	22966	Single gang Frame	Gray	1	1
FLBC8510LA	22976	Single gang Frame	Light Almond	1	1
FLBC8510CA	22975	Single gang Frame	Caramel	1	1

Includes single gang frame, (1) flip lid cover with gasket, (1) 20A decorator-style receptacle, (1) gasket, (1) low voltage insert, installation screws.

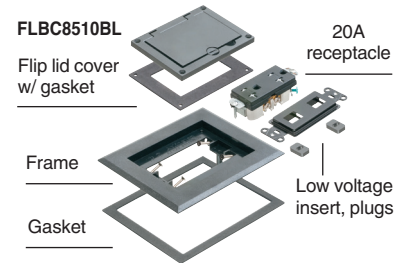

FLBC8520BL

TWO GANG PLASTIC COVER / FRAME KITS

FLBC8520BL	22967	Two gang Frame	Black	1	1
FLBC8520BR	22968	Two gang Frame	Brown	1	1
FLBC8520GY	22969	Two gang Frame	Gray	1	1
FLBC8520LA	22978	Two gang Frame	Light Almond	1	1
FLBC8520CA	22977	Two gang Frame	Caramel	1	1

Includes two gang frame, (2) flip lid covers with gaskets, (2) 20A decorator-style receptacles, (2) gaskets, (2) low voltage inserts, installation screws.

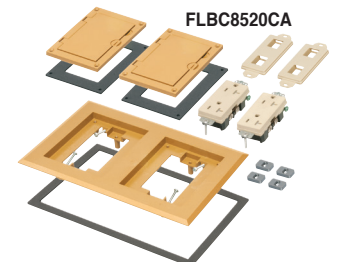

FLBC8520CA



FLBC8530GY

THREE GANG PLASTIC COVER / FRAME KITS

FLBC8530BL	22970	Three gang Frame	Black	1	1
FLBC8530BR	22971	Three gang Frame	Brown	1	1
FLBC8530GY	22972	Three gang Frame	Gray	1	1
FLBC8530LA	22980	Three gang Frame	Light Almond	1	1
FLBC8530CA	22979	Three gang Frame	Caramel	1	1

Includes three gang frame, (3) flip lid covers with gaskets, (3) 20A decorator-style receptacles, (3) gaskets, (3) low voltage inserts, installation screws.

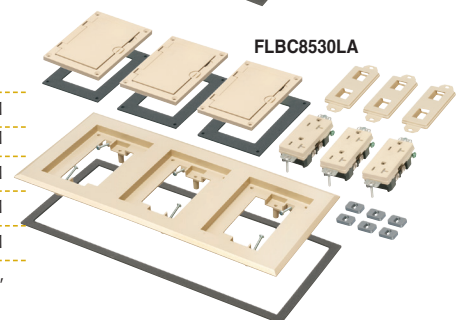

FLBC8530LA

METAL COVERS

FOR NEW CONCRETE, COMMERCIAL WORK

PLATED BRASS & PLATED NICKEL

(3) FLBC8500 boxes
(1) FLBC8530NL Kit



Patented

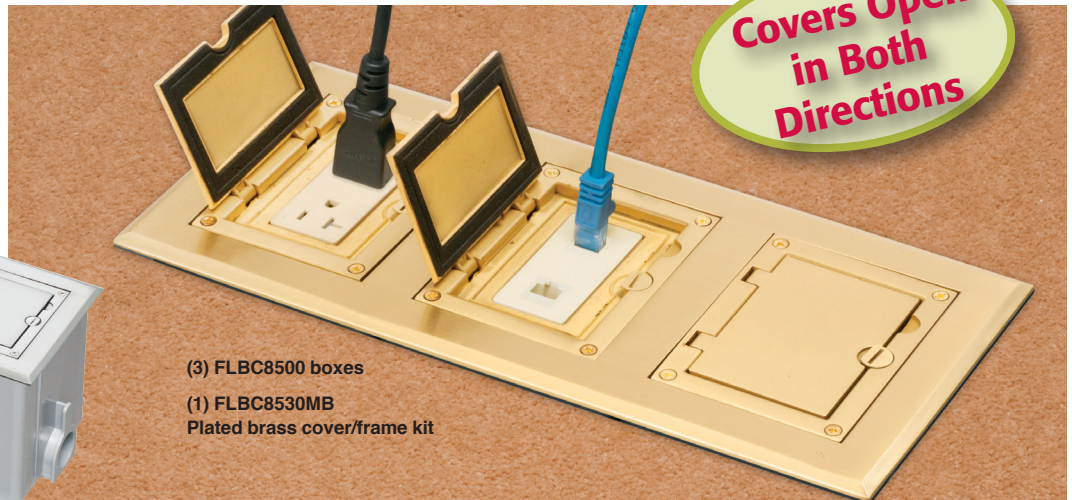

Covers Open in Both Directions

(3) FLBC8500 boxes
(1) FLBC8530MB
Plated brass cover/frame kit

COVER KITS FOR FLBC8500, FLBC8502



CATALOG NUMBER	UPC/DCI/NAED MFG. #018997	DESCRIPTION	PLATED ZINC COVER FINISH	UNIT PKG	STD PKG
FLBC8501MB	22951	Single gang Flip Lid Cover	Brass-plated zinc	1	10
FLBC8501NL	22952	Single gang Flip Lid Cover	Nickel-plated zinc	1	10

Includes METAL single gang gasketed flip lid cover, (1) 20A decorator-style receptacle, (1) low voltage insert.

SINGLE GANG COVER / FRAME KITS

FLBC8510MB	22953	Single gang Frame	Brass-plated zinc	1	1
FLBC8510NL	22954	Single gang Frame	Nickel-plated zinc	1	1

Includes single gang frame, (1) flip lid cover with gasket, (1) 20A decorator-style receptacle, (1) gasket, (1) low voltage insert, installation screws.

TWO GANG COVER / FRAME KITS

FLBC8520MB	22955	Two gang Frame	Brass-plated zinc	1	1
FLBC8520NL	22956	Two gang Frame	Nickel-plated zinc	1	1

Includes two gang frame, (2) flip lid covers with gaskets, (2) 20A decorator-style receptacles, (2) gaskets, (2) low voltage inserts, installation screws.

THREE GANG COVER / FRAME KITS

FLBC8530MB	22957	Three gang Frame	Brass-plated zinc	1	1
FLBC8530NL	22958	Three gang Frame	Nickel-plated zinc	1	1

Includes three gang frame, (3) flip lid covers with gaskets, (3) 20A decorator-style receptacles, (3) gaskets, (3) low voltage inserts, installation screws.

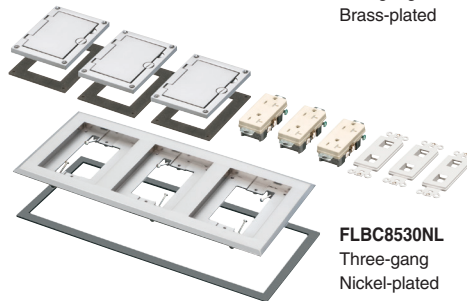
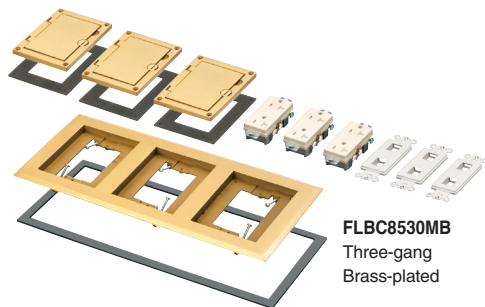
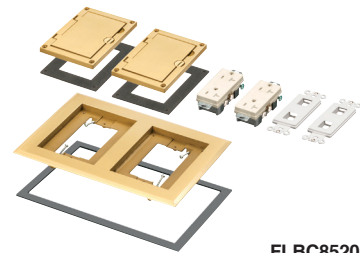
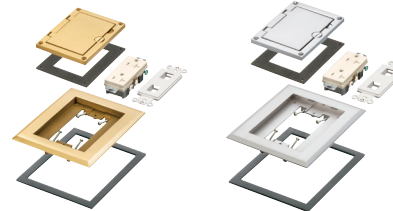

FLBC8520MB
Two-gang
Brass-plated

FLBC8520NL
Two-gang
Nickel-plated
not shown



RECESSED DIECAST COVER KITS

FIT FLBC8500, FLBC8502 BOXES



Patented

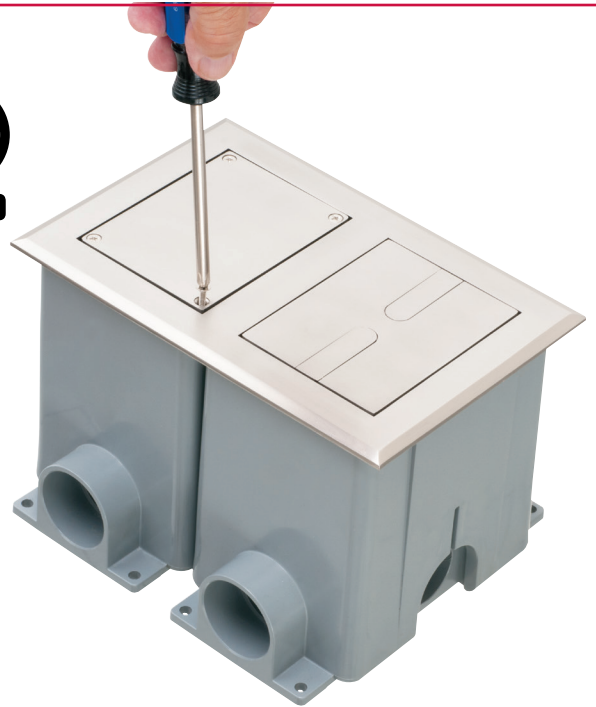

(2) FLBC8500 boxes
(1) FLBC8528NL
Nickel-plated cover/frame kit

The RECESSED, gasketed frames in this series fit our FLBC8500 and FLBC8502 concrete boxes. The recessed design minimizes tripping when cords are plugged in.

We also offer single, two- and three-gang cover/frame kits with furniture feed inserts (see page 8).

Call our Sales Help Desk for cover interchangeability options.

Diecast zinc frames and covers are available with brass-plated or nickel-plated finishes.

RECESSED Cover Kit Components

FLBC8518MB shown

Blank cover w/ gasket and mounting screws

Slotted in-use cover w/ removable tabs

Frame w/ recessed 20A receptacle

Colored insert

Gasket

Low voltage keystone insert



Recessed frame/cover kit

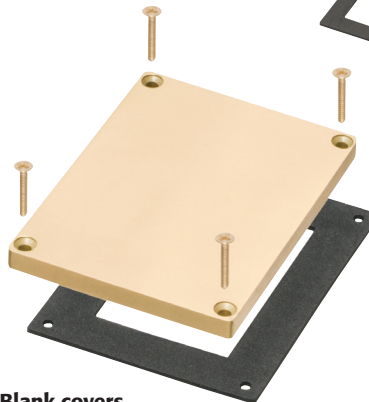

Blank covers protect receptacle(s) when not in use

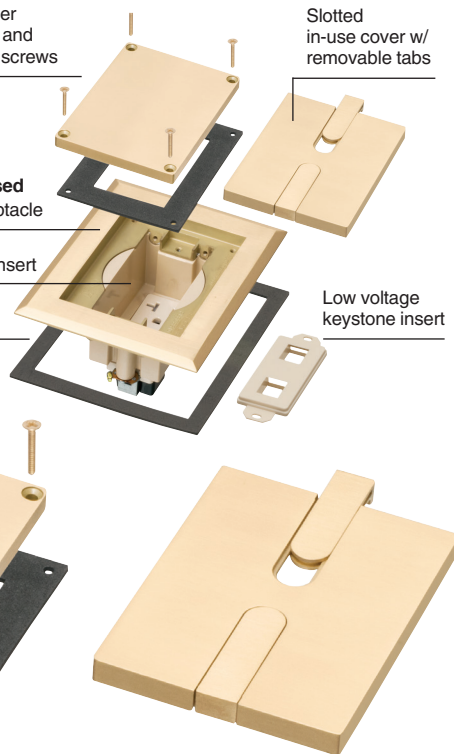

Dual slotted in-use covers with removable tabs



FLBC85i8MB



FLBC8528NL



FLBC8538NL without covers

PLATED ZINC

FOR NEW CONCRETE, COMMERCIAL WORK

BRASS PLATED & NICKEL PLATED

(3) FLBC8500 boxes
(1) FLBC8538NL Kit

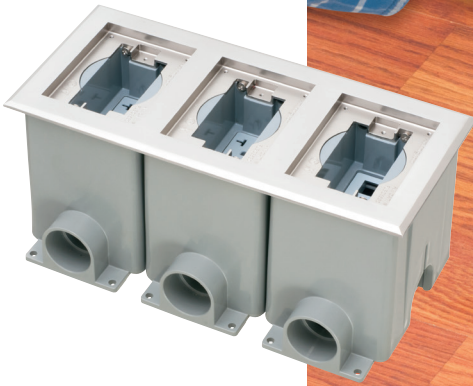

(3) FLBC8500 boxes
(1) FLBC8538MB
Plated brass cover/frame kit

Patented

RECESSED COVER KITS FOR FLBC8500, FLBC8502



CATALOG NUMBER	UPC/DCI/NAED MFG. #018997	DESCRIPTION	PLATED ZINC COVER FINISH	UNIT PKG	STD PKG
FLBC8508MB	22983	Single gang blank, slotted covers	Brass-plated zinc	1	10
FLBC8508NL	22984	Single gang blank, slotted covers	Nickel-plated zinc	1	10

Includes gasketed blank cover with mounting screws, single gang dual slotted in-use cover with removable tabs. Works with Arlington's FLBC8518, FLBC8528 and FLBC8538 recessed cover kit frames.

SINGLE GANG RECESSED COVER / FRAME KITS

FLBC8518MB	22985	Single gang Frame	Brass-plated zinc	1	1
FLBC8518NL	22986	Single gang Frame	Nickel-plated zinc	1	1

Includes single gang recessed frame with gasket and installed 20A receptacle, colored insert, low voltage keystone insert, gasketed blank cover with mounting screws, dual slotted in use cover with removable tabs.

TWO GANG RECESSED COVER / FRAME KITS

FLBC8528MB	22987	Two gang Frame	Brass-plated zinc	1	1
FLBC8528NL	22988	Two gang Frame	Nickel-plated zinc	1	1

Includes two gang recessed frame with gasket, (2) 20A receptacles, colored insert, (2) low voltage keystone inserts, (2) gasketed blank covers with mounting screws, (2) dual slotted in-use covers with removable tabs.

THREE GANG RECESSED COVER / FRAME KITS

FLBC8538MB	22989	Three gang Frame	Brass-plated zinc	1	1
FLBC8538NL	22990	Three gang Frame	Nickel-plated zinc	1	1

Includes three gang recessed frame with gasket, (3) 20A receptacles, colored insert, (3) low voltage keystone inserts, (3) gasketed blank covers with mounting screws, (3) dual slotted in-use covers with removable tabs.

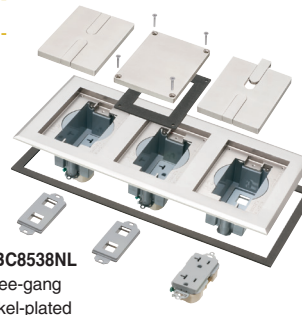
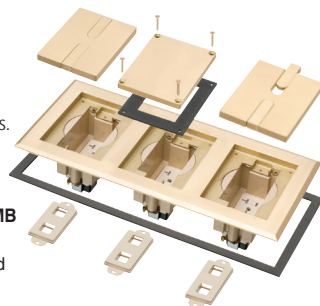
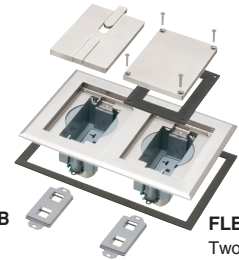
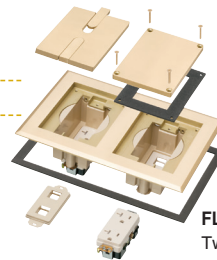
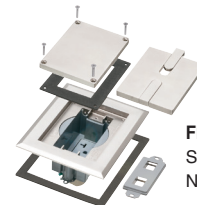
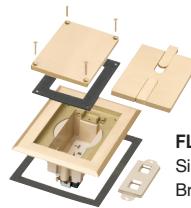
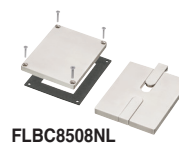

FLBC8538MB
Three-gang
Brass-plated

FLBC8538NL
Three-gang
Nickel-plated



MORE PLATED DIECAST COVER KITS

FIT FLBC8500, FLBC8502 BOXES

(3) FLBC8500 boxes
(1) FLBC8533NL Kit

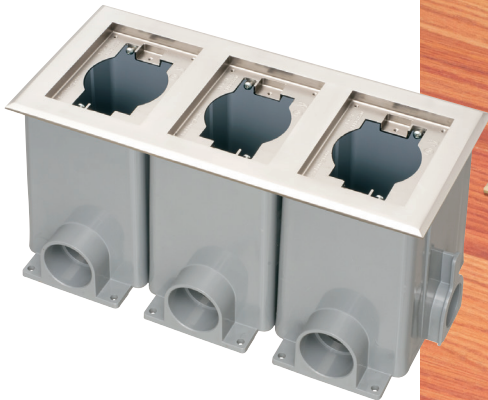

Patented



(3) FLBC8500 boxes
(1) FLBC8533MB
Plated brass cover/frame kit

COVER KITS FOR FLBC8500, FLBC8502 WITH FURNITURE FEED INSERTS

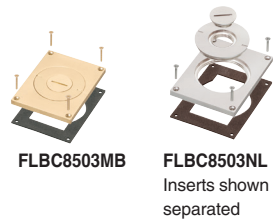

FLBC8503MB

FLBC8503NL
Inserts shown separated

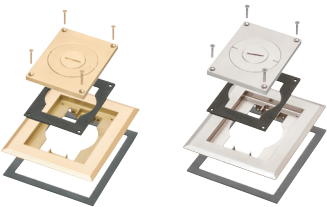

FLBC8513MB

FLBC8513NL

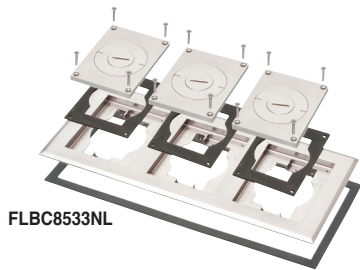

FLBC8533NL

CATALOG NUMBER	UPC/DCI/NAED MFG. #018997	DESCRIPTION	PLATED ZINC COVER FINISH	UNIT PKG	STD PKG
FLBC8503MB	22943	Single gang cover w/ inserts	Brass-plated zinc	1	10
FLBC8503NL	22944	Single gang cover w/ inserts	Nickel-plated zinc	1	10

Includes gasketed cover with combo 2" and 3/4" threaded holes and (4) mounting screws.
Works with Arlington's FLBC8518, FLBC8528 and FLBC8538 recessed cover kit frames.

SINGLE GANG COVER / FRAME KITS

FLBC8513MB	20821	Single gang Frame	Brass-plated zinc	1	1
FLBC8513NL	20822	Single gang Frame	Nickel-plated zinc	1	1

Includes single gang frame with gasket, (1) gasketed cover with combo 2" and 3/4" threaded holes and (4) mounting screws.

TWO GANG COVER / FRAME KITS

FLBC8523MB	20823	Two gang Frame	Brass-plated zinc	1	1
FLBC8523NL	20824	Two gang Frame	Nickel-plated zinc	1	1

Includes two gang frame with gasket, (2) gasketed covers with (2) combo 2" and 3/4" threaded holes in each, and (4) mounting screws..

THREE GANG COVER / FRAME KITS

FLBC8533MB	20825	Three gang Frame	Brass-plated zinc	1	1
FLBC8533NL	20826	Three gang Frame	Nickel-plated zinc	1	1

Includes three gang frame with gasket, (3) gasketed covers with (2) combo 2" and 3/4" threaded holes in each, and (4) mounting screws..

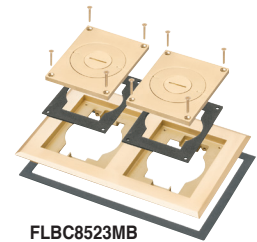

FLBC8523MB

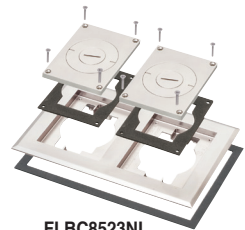

FLBC8523NL

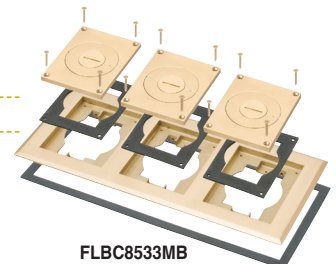

FLBC8533MB

Patented/Other patents pending



Distributed by



Arlington®

1 Stauffer Industrial Park. Scranton, PA 18517

800.233.4717 • www.aifittings.com • EMAIL sales@aifittings.com