

## DESCRIPTION

The H7 recessed housing is the standard in the industry for both commercial and residential applications. The wide variety of trims available allows a number of different lighting effects to be created with one basic housing.

## APPLICATION

The H7T is a suited for use in non-insulated ceilings in residential and commercial applications. If ceiling insulation is present, it must be kept 3" from the fixtures on all sides.

## DESIGN FEATURES

### A...Housing

Die-stamped 20 gauge CRS with white powder coat finish.

### B...Socket Plate

Rigid socket plate adjusts and locks without tools for various lamp sizes.

### C...Plaster Frame

Housing adjusts in plaster frame 1 3/8" to accommodate different ceiling thicknesses. Plaster frame features include:

- Regressed locking screw for securing hanger bars
- Cutouts for easily crimping hanger bars in position
- Halo name embossed on plaster frame Galvanized steel construction. The housing can be removed from plaster frame to provide access to the junction box.

### D...Junction Box

- Junction box features include:
- UL listed for through branch circuit wiring

- Positioned to accommodate straight conduit runs
- Seven 1/2" trade size conduit knockouts with true pry-out slots
- Slide-N-Side™ connectors allow 14/2 or 12/2 non-metallic sheathed cable to be installed without tools and without removing knockouts

### E...GOT NAIL! Pass-N-Thru™ Bar Hangers

Bar Hanger Features include:

- Pre-installed nail easily installs in regular lumber, engineered lumber and laminated beams
- Safety and guidance system prevents snagging, ensures smooth straight nail penetration and allows bar hangers to be easily removed if necessary.
- Automatic levelling flange aligns the housing and lets you hold the housing in place with one hand while driving nails
- Housing can be positioned at

- any point within 24" joist span
- Score lines allow "toolless" shortening for 12" joists
- Bar hangers may be repositioned 90°
- Bar hangers do not need to be removed from frame for shortening
- Integral T-bar clips snaps onto T-bars - no additional clips required

### F...Socket

Porcelain socket with nickel plated brass screw shell.

### G...Thermal Protector

Self resetting thermal protector deactivates fixture if overheating occurs due to improper lamping or misapplied insulation.

### Labels

- UL Listed for Damp Location
- UL listed for Feed Through
- CSA Certified
- IP Rated

Catalog #	Type
Project	
Comments	
Prepared by	Date

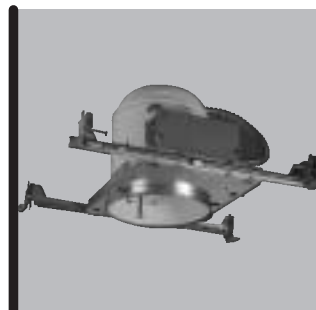

## H7T

### 6" Non-Insulated Ceiling Recessed Housing

6" TRIMS

FOR USE IN NON-INSULATED CEILINGS OR INSULATED CEILINGS BUT INSULATION MUST BE KEPT 3" FROM ALL SIDES OF FIXTURE

This housing is AIR-TITE when used with the following Trims:

- 170PS
- 171PS
- 173PS
- 78PAT
- 30 (All Styles)
- 430 (All Styles)

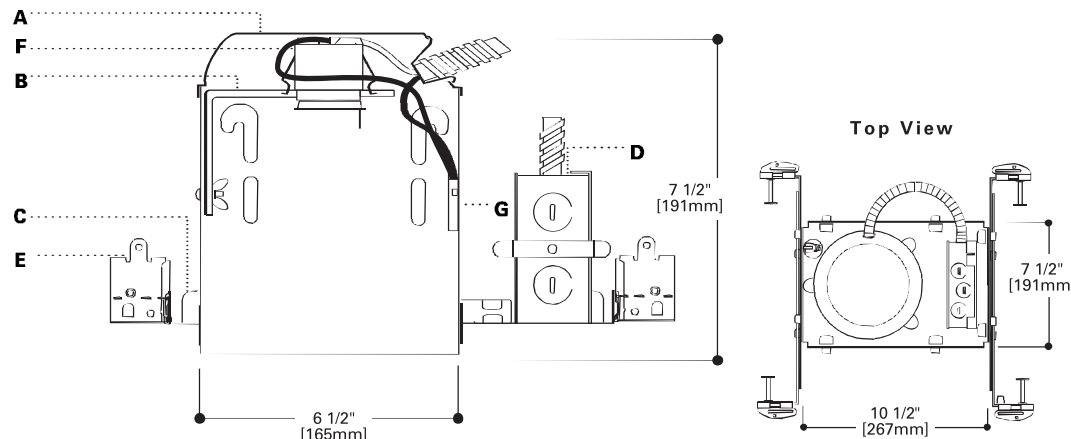

## ORDERING INFORMATION SAMPLE NUMBER: H7T-426RG

Order housing, trim and accessories separately.

Housing	Trims	Accessories
<b>H7T</b>		
Non-Insulated Ceiling Housing	See reverse side	

### Metal Trim Rings

Compatible with 310, 376, 378, 410, 419, 420, 424, 425, 426, 1412, 1416, 1475  
**TRM6P**=White Metal **TRM6PB**=Polished Brass **TRM6C**=Chrome  
**TRM6MB**=Black Metal **TRM6SL**=Silver Metal **TRP7MB**=Black Plastic

### Oversize Trim Rings

For use when ceiling opening is cut too large. Compatible with 310, 376, 378, 405, 410, 419, 420, 424, 425, 426, 429, 1412, 1416, 1475

**OT400P**=9 1/4" White Metal

**OT403P**= 8" White Plastic

### Step Down Transformer

Steps 277V line voltage down to 120V fixture operating voltage. 150VA max. **H277**=150VA Max.

## UPGRADE FEATURES:

- SLIDE-N-SIDE™ JUNCTION BOX
- GOT NAIL!™ BAR HANGERS
- PASS-N-THRU™ BAR HANGERS
- REGRESSED LOCKING SCREW
- HALO ID ON PLASTER FRAME

ADV042492

Supersedes ADV031586, ADV023109 & ADV000304

9/04

TAB: Recessed Incandescent Sheet 23

Trims

REFLECTORS

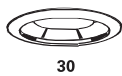

30



30



405



426



429



4051



4261

BAFFLES

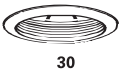

30

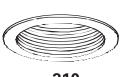

310

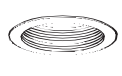

410

ADJUSTABLES



74

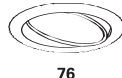

76



77



78



90

**AIR-TITE Super Trim**  
150W A21, 150W PAR38, 100W R30,  
75W PAR30, 75W PAR30L, 65W BR30  
30CAT=Specular Clear, Air-Tite  
30HAT=Haze, Air-Tite  
30RGAT=Residential Gold, Air-Tite  
OD: 7 1/4" (184mm)

**AIR-TITE Super Trim**  
50W PAR30, 75W PAR30L, 100W R30,  
85W BR30, 150W R40, 120W BR40,  
100W A19, 150W PAR38, 150W A21  
30SBAT=Specular Black, Air-Tite  
OD: 7 1/4" (184mm)

**Specular Reflector**  
150W A21  
405SC=Specular Clear  
405H=Haze  
405RG=Residential Gold  
405CG=Champagne Gold  
OD: 7 1/4" (184mm)

**Specular Reflector Cone**  
75W R30, 65W BR30, 75W PAR30,  
150W R40, 150W PAR38  
426=Specular Clear  
426H=Haze  
426RG=Residential Gold  
426CG=Champagne Gold  
426MB=Specular Black  
OD: 7 1/4" (184mm)

**Dayform Cone**  
75W R30, 65W BR30  
429P=White  
OD: 7 1/4" (184mm)

**Self Flanged Reflector**  
150W A21  
4051P=White  
OD: 7 1/4" (184mm)

**Self Flanged Reflector Cone**  
75W R30, 65W BR30, 75W PAR30,  
150W R40, 150W PAR38  
4261P=White  
OD: 7 1/4" (184mm)

**AIR-TITE Super Trim**  
100W A19, 150W PAR38, 100W R30,  
75W PAR30, 65W BR30, 75W PAR30L  
30PAT=Black Baffle  
30WAT=White Baffle  
OD: 7 1/4" (184mm)

**Baffle**  
75W R30, 65W BR30, 75W PAR30  
310P=Black Baffle  
310W=White Baffle  
OD: 7 1/4" (184mm)

**Baffle**  
150W PAR38, 150W R40  
410P=Black Baffle  
410W=White Baffle  
OD: 7 1/4" (184mm)

**Eyeball - 30° Tilt**  
75W PAR30  
74P=White Eyeball  
OD: 8" (203mm)

**Adjustable - 30° Tilt**  
150W PAR38 Side Prong  
76P=White Eyeball  
OD: 8" (203mm)

**Eyeball**  
50W R20, 50W PAR20  
77P=White Eyeball  
OD: 8" (203mm)

**Eyeball - 30° Tilt**  
75W R30, 65W BR30, 75W PAR30L  
78P=White Eyeball  
78SL=Silver  
78B=Brass Eyeball  
78PB=Polished Brass Eyeball  
78PAT=Polished Brass Eyeball (converts  
H7T to AIR-TITE Construction)  
OD: 8" (203mm)

**Adjustable - 60° Tilt**  
250W PAR38  
90P=White "Double Bubble"  
OD: 8" (203mm)



376



378

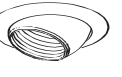

417



419



420



478

DIFFUSERS



70



71

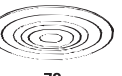

73

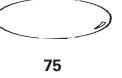

75



416



172

OPEN



79



301



328

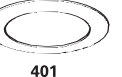

401



428

**Adjustable**  
75W PAR30  
376P=Black Baffle, White Trim Ring  
OD: 7 1/4" (184mm)

**Adjustable with Splay Reflector**  
75W PAR30  
378=White w/ Specular Clear Splay Reflector  
378P=White w/ White Splay Reflector  
OD: 7 1/4" (184mm)

**Coilex Baffle Eyeball**  
75W PAR30  
417P=White with Black Baffle  
417PB=Brass with Black Baffle  
417W=Brass with White Baffle  
OD: 8" (203mm)

**Regressed Eyeball**  
75W PAR30  
419=White w/ Specular Clear Splay Reflector  
419P=White w/ White Splay Reflector  
OD: 8" (203mm)

**Coilex Regressed Eyeball**  
75W BR30, 75W PAR30L  
420P=Black Baffle, White Eyeball  
420PB=Black Baffle, Polished Brass  
Eyeball  
420W=White Baffle, White Eyeball  
OD: 7 1/4" (184mm)

**Adjustable with Splay - 25° Tilt**  
90W PAR38  
478=White w/ Specular Clear Splay Reflector  
478P=White w/ White Splay Reflector  
OD: 7 1/4" (184mm)

**Glass Albalite Lens**  
60W A19  
70P=White Trim Ring  
70PS=White Trim Ring, Shower Light  
OD: 8" (203mm)

**Plastic Drop Opal**  
60W A19  
71P=White Trim Ring  
71PS=White Trim Ring, Shower Light  
OD: 8" (203mm)

**Glass Fresnel Lens**  
60W A19  
73P=White Trim Ring  
73PS=White Trim Ring, Shower Light  
OD: 8" (203mm)

**All-Glas Diffuser**  
60W A19  
75=All Glass Diffuser  
OD: 7 3/4" (197mm)

**Coilex with Semi-Regressed Drop Opal**  
60W A19  
416P=Black Baffle  
416W=Black Baffle  
OD: 7 1/4" (184mm)

**Shower Light**  
100W A19, 75W PAR30  
172PS=White Trim Ring, Shower Light  
OD: 7 3/4" (197mm)

**Pinhole Trim**  
50W R20  
79P=White  
OD: 8" (203mm)

**Open**  
75W R30, 75W PAR30, 65W BR30  
301P=White Open  
301PB=Brass Open  
OD: 7 1/4" (184mm)

**Splay Trim**  
75W R30, 75W PAR30, 65W BR30  
328P=White Splay  
OD: 7 1/4" (184mm)

**Open**  
75W R30, 65W BR30, 75W PAR30  
401P=White Open  
401AL=Aluminum Open  
401PB=Polished Brass Open  
OD: 8" (203mm)

**Splay Trim**  
150W R40  
428P=White Splay  
OD: 7 1/4" (184mm)

WALL WASH



303



424



425

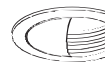

430

LOW VOLTAGE



1412



1416

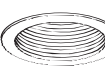

1416BA



1417



1450



1475

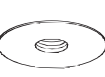

1479

**Wall Wash**  
60W A19  
303P=White Wall Wash  
OD: 8" (203mm)

**Wall Wash**  
100W A19  
424P=White Wall Wash  
OD: 7 1/4" (184mm)

**Coilex Wall Wash**  
60W A19  
425P=White Wall Wash w/ Black  
Baffle  
425W=White Wall Wash w/ White  
Baffle  
OD: 7 1/4" (184mm)

**Baffle Wall Wash**  
40W A19  
430P=Black Baffle, White Scoop,  
White Trim Ring  
430W=White Baffle, White Scoop,  
White Trim Ring  
OD: 7 1/4" (184mm)

**Adjustable Spot - 30° tilt (Includes  
12V transformer for retrofit)**  
50W 12V MR16  
1412P=Black Baffle, Black Spot,  
White Trim Ring  
1412W=White Baffle, White Spot,  
White Trim Ring  
OD: 7 1/4" (184mm)

**Specular Reflector - 30° tilt (Includes  
12V transformer for retrofit)**  
50W 12V MR16  
1416C=Clear Specular Reflector  
1416CG=Champagne Gold Specular  
Reflector  
OD: 7 1/4" (184mm)

**Baffle - 30° tilt (Includes 12V  
transformer for retrofit)**  
50W 12V MR16  
1416BA=Black Baffle, White Trim  
Ring  
1416W=White Baffle, White Trim  
Ring  
OD: 7 1/4" (184mm)

**Coilex Baffle Eyeball - 30° tilt  
(Includes 12V transformer for  
retrofit)**  
50W 12V MR16  
1417P=White Eyeball, Black  
Baffle, White  
Trim Ring  
1417W=White Eyeball, White  
Baffle, White  
Trim Ring  
OD: 8" (203mm)

**Adjustable Slot Aperture 30° tilt  
(Includes 12V transformer for  
retrofit)**  
50W 12V MR16  
1450P=White  
OD: 7 1/4" (184mm)

**Adjustable Accent - 30° tilt (Includes  
12V transformer for retrofit)**  
50W 12V PAR36  
1475P=White Holder, Black Baffle,  
White Trim Ring  
1475W=White Holder, White Baffle,  
White Trim Ring  
OD: 7 1/4" (184mm)

**1 7/8" Pinhole Downlight (Includes  
12V transformer for retrofit)**  
50W 12V MR16  
1479P=White Trim, Black Baffle  
1479W=White Trim, White Baffle  
OD: 7 1/4" (184mm)

Note: Specifications and Dimensions subject to change without notice.

Visit our web site at [www.cooperlighting.com](http://www.cooperlighting.com)