

COOPER LIGHTING - METALUX®

DESCRIPTION

The HBL series is ideal for high mounting height industrial or retail applications. Advanced optical designs provide maximum performance from either T5 or T8 lamps. Optional upright component produces excellent ceiling uniformity. HBL's high lumen package allows the benefits of fluorescent to be applied at high mounting heights that were traditionally exclusive to H.I.D. Benefits include exceptional color rendering, high system efficacy, 95% lumen maintenance, long lamp life, instant on/instant re-strike, economical dimming, and uniform brightness control. Typical HBL applications include retail, shopping malls, light industrial and recreational environments.

Catalog #		Type
Project		
Comments		Date
Prepared by		

SPECIFICATION FEATURES

Construction

Channel and end plates are constructed of die formed steel. The channel provides strength, numerous KO's for easy installation, and excellent thermal dissipation without any special or proprietary components. Stiffening brackets add additional strength and rigidity to channel and reflectors.

Electrical

The HBL comes with a standard Class "P" electronic ballast and twist-lock lampholders. UL/cUL listed for high ambient environments up to 55°C (131°F) for all lamp and ballast combinations listed. Suitable for damp locations.

Finish

Electrostatically applied baked white enamel finish is preceded by a multistage cleaning cycle, iron phosphate coating with rust inhibitor.

Optics

Die formed, segmented optical design optimizes performance across three distributions. Optical choices include a narrow distribution for aisles, medium distribution for assembly and loading areas, or wide distribution for general, open area lighting. An upright option is offered to permit ceiling uniformity and allow for ample lamp and luminaire heat dissipation.

Warranty

When operated in high ambient conditions, the HBL is supported by a 5 yr/55°C and 3 yr/65°C ballast warranty for T5 and T8 (277V) options when used w/high temperature ballast in open, upright configurations. To maximize your warranty, the HBL should be ordered with a high-temperature ballast in ambient environments that typically exceed 40°C (102°F).



HBL SERIES

4 OR 6 T8 LAMPS

High-Bay Industrial Open Luminaire

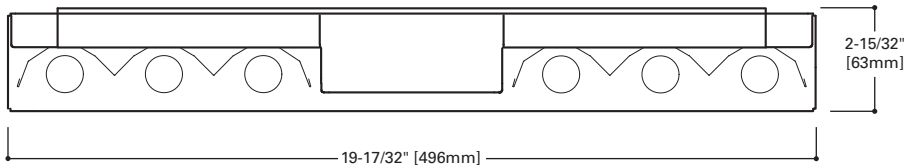

DIMENSION TOP VIEW

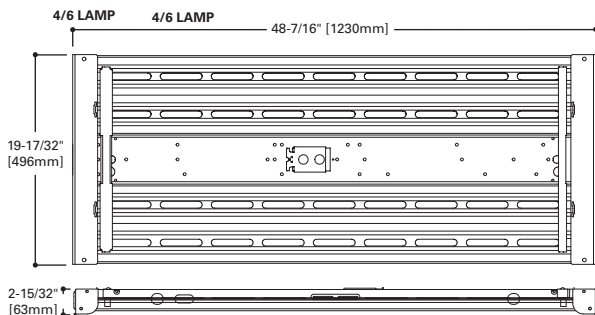

LAMP CONFIGURATIONS

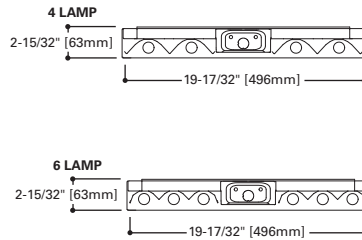

ENERGY DATA

Input Watts:
EB Ballast and STD Lamps
 432=109
 632=167

Luminaire Efficacy Rating
LER = 88 (White)
LER = 90 (Specular Inserts)
Catalog Number: HBL-632-UPL

**Yearly Cost of 1000 lumens,
 3000 hrs at .08 KWH = \$2.67**

*Reference the lamp/ballast data in the Technical Section for specific lamp/ballast requirements.

**Consult Pre Sales Technical Support.

LAMPS CONTAIN MERCURY. DISPOSE ACCORDING TO LOCAL, STATE OR FEDERAL LAWS



ADF081930 pc
 2011-03-29 14:20:21

PHOTOMETRICS

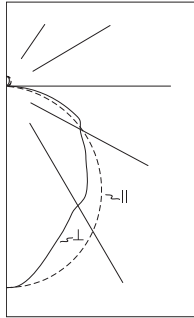

HBL-632-N-UPL
Narrow Distribution
 (2) Electronic Plus Ballasts
 (6) F32/T8/TL835 32W T8 lamps, 3100 lumens
 Spacing criterion: (II) 1.3 x mounting height, (L) 1.0 x mounting height
 Efficiency 95.9%
 Test Report: HBL632NUPL.IES
 LER =90
 Yearly Cost of 1000 lumens, 3000 hrs at .08 KWH = \$2.67

Candela			
Angle	Along II	45°	Across L
0	6445	6445	6445
5	6418	6359	6322
10	6339	6092	5913
15	6200	5715	5455
20	6008	5300	5075
25	5761	4910	4736
30	5464	4549	4478
35	5119	4178	4363
40	4731	3898	4043
45	4302	3674	3636
50	3840	3287	3321
55	3346	2841	2987
60	2827	2482	2737
65	2286	2118	2614
70	1732	1892	2148
75	1179	1543	1622
80	654	1018	1094
85	201	522	592
90	3	117	182

PHOTOMETRICS

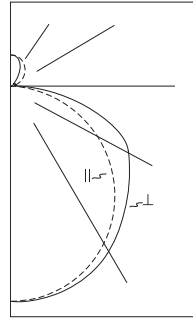

HBL-632-W-UNV-EB82-UPL
Wide Distribution
 (2) Electronic Plus Ballasts
 (6) F32T8/835 32WT8 lamps, 3100 lumens
 Spacing criterion: (II) 1.3 x mounting height, (L) 1.3 x mounting height
 Efficiency 90.5%
 Test Report: HBL632WUPL.IES
 LER =88
 Yearly Cost of 1000 lumens, 3000 hrs at .08 KWH = \$2.73

Candela			
Angle	Along II	45°	Across L
0	4685	4685	4685
5	4663	4674	4692
10	4608	4631	4654
15	4512	4555	4594
20	4380	4446	4503
25	4209	4303	4374
30	4000	4121	4203
35	3762	3909	4000
40	3492	3658	3774
45	3195	3377	3562
50	2870	3081	3354
55	2527	2785	3150
60	2165	2500	2962
65	1781	2230	2707
70	1384	1985	2246
75	975	1569	1685
80	569	1025	1107
85	200	500	566
90	3	111	177

Coefficients of Utilization

rc	Effective floor cavity reflectance																	
	80%			70%			50%			30%			10%			0%		
rw	70	50	30	70	50	30	70	50	30	70	50	30	70	50	30	0		
RCR																		
0	113	113	113	110	110	110	104	104	104	99	99	99	94	94	94	92		
1	103	98	93	89	100	95	91	88	90	87	84	86	83	81	82	80	78	75
2	93	85	78	72	90	82	76	71	78	73	69	75	70	66	71	68	64	62
3	85	74	66	60	82	72	65	59	69	62	57	66	60	56	63	58	54	52
4	77	66	57	50	75	64	56	50	61	54	49	58	52	47	56	51	46	44
5	71	58	50	43	69	57	49	43	55	47	42	52	46	41	50	45	40	38
6	66	53	44	38	64	52	43	37	49	42	37	47	41	36	45	40	35	33
7	61	48	39	33	59	47	39	33	45	38	33	43	37	32	42	36	31	29
8	57	44	35	30	55	43	35	30	41	34	29	40	33	29	38	33	28	26
9	53	40	32	27	51	39	32	27	38	31	26	37	30	26	35	30	26	24
10	50	37	29	24	48	36	29	24	35	28	24	34	28	24	33	27	23	22

Coefficients of Utilization

rc	Effective floor cavity reflectance																	
	80%			70%			50%			30%			10%			0%		
rw	70	50	30	70	50	30	70	50	30	70	50	30	70	50	30	0		
RCR																		
0	106	106	106	106	103	103	103	103	97	97	97	91	91	91	86	86	86	83
1	96	91	87	83	93	88	84	81	83	80	77	78	76	73	74	72	70	68
2	86	78	72	66	83	76	70	65	72	67	62	68	63	60	64	60	57	55
3	78	68	60	54	75	66	59	53	62	56	51	59	54	50	56	52	48	46
4	71	60	52	45	69	58	51	45	55	49	43	52	47	42	49	45	41	38
5	65	53	45	39	63	52	44	38	49	42	37	47	41	36	44	39	35	33
6	60	48	40	34	58	47	39	33	44	37	32	42	36	31	40	35	31	28
7	56	43	35	29	54	42	34	29	40	33	28	38	32	28	36	31	27	25
8	52	39	31	26	50	38	31	26	37	30	25	35	29	25	33	28	24	22
9	48	36	28	23	47	35	28	23	34	27	23	32	26	22	31	25	22	20
10	45	33	26	21	44	32	26	21	31	25	20	30	24	20	28	23	20	18

Zonal Lumen Summary

Zone	Lumens	%Lamp	%Fixture
0-30	4562	24.5	25.6
0-40	7330	39.4	41.1
0-60	12827	69.0	71.9
0-90	17094	91.9	95.8
0-180	17837	95.9	100.0

Luminance Data

Angle in Deg	Average 0-Deg cd/sm	Average 45-Deg cd/sm	Average 90-Deg cd/sm
45	10283	8782	8691
55	9860	8372	8802
65	9142	8470	10454
75	7699	10076	10592
85	3898	10123	11480

Zonal Lumen Summary

Zone	Lumens	%Lamp	%Fixture
0-30	3714	20.0	22.1
0-40	6154	33.1	36.6
0-60	11290	60.7	67.1
0-90	15508	83.4	92.1
0-180	16834	90.5	100.0

Luminance Data

Angle in Deg	Average 0-Deg cd/sm	Average 45-Deg cd/sm	Average 90-Deg cd/sm
45	7432	7855	8286
55	7247	7987	9033
65	6932	8679	10536
75	6196	9971	10708
85	3774	9436	10682

Modular F-Bay Power Supply Option

Cooper Lighting's F-Bay Modular Power Supply option is available for use with all F-Bay products. The modular power supply allows external fixture access for safe and easy servicing. There is no need to remove lamps or reflectors to disconnect fixture power with F-Bay Modular Power Supply. Access to the individual fixture's power supply allows servicing without turning off all the fixtures, disrupting occupants. F-Bay Modular Power Supply is a time-saver in installation – **simply plug & power.**



1. Modular Power Supply Receptacle supplied mounted into fixture Access Plate
2. Modular Power Cord & Plugs in 120, 277, 347, & 480V configurations for easy plug & power into existing supply

No internal fixture access required for installation or disconnecting power

Modular Motion Sensor Option supplied with Mounting Box and Modular Power Supply Receptacle

Code Compliance

- UL/cUL Certified for Make/Break under load (UL2549)
- Meets NEC requirements for ballast disconnect (NEC 410.73G)
- Allows for addition of Occupancy Sensor without hard connections
- Receptacles complete with insulating/dust cap

ORDERING INFORMATION

SAMPLE NUMBER: HBL-632-N-UNV-EB82-UPL-U Includes V Hangers for rapid installation⁽⁶⁾

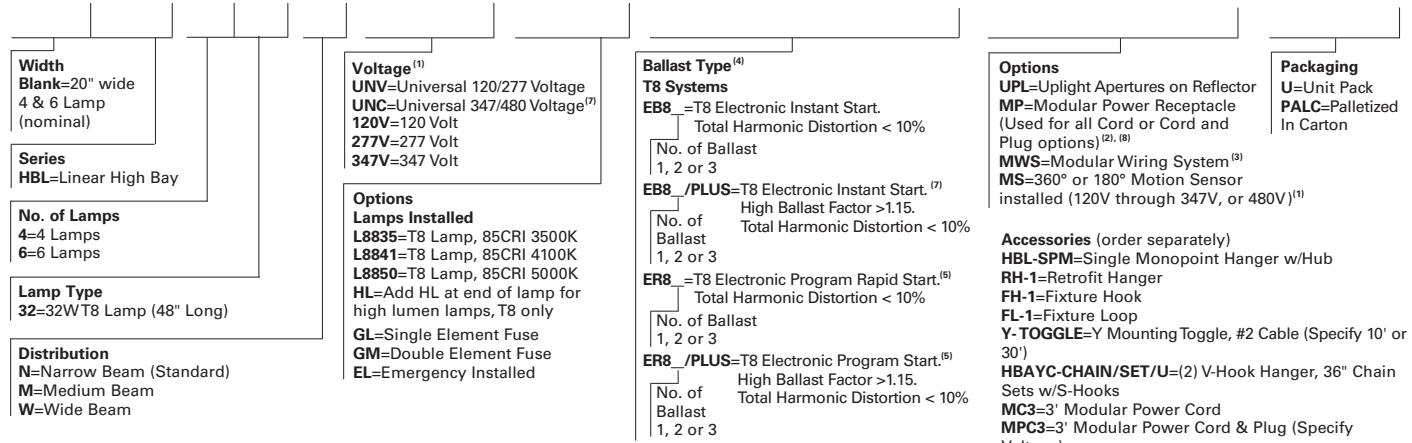

NOTES: ⁽¹⁾Voltage must be specified when ordered with plugs or emergency ballasts. For MS option, indicate UNV (for 120V or 277V), 347V or 480V. ⁽²⁾Requires use of MC_ or MPC_ cord accessories, specify voltage for plugs. ⁽³⁾Cannot be combined with Modular Power Receptacle (MP). ⁽⁴⁾T8 ballast systems suitable for operation in ambient environments up to 131°F (55°C) in upright configuration. ⁽⁵⁾Recommended when using motion sensor options. ⁽⁶⁾Can be used in high abuse applications such as gymnasiums. ⁽⁷⁾2/3 lamp ballast configuration in EB8/PLUS only for UNC version. ⁽⁸⁾For MWS with MP, choose MP in fixture logic and then choose MWS accessory such as MDS6.

SHIPPING DATA

Catalog No.	Wt.
HBL-432-UNV-UPL	13.5 lbs.
HBL-632-UNV-UPL	15 lbs.

QUICK SHIP ORDERING INFORMATION



Quick Ship Ordering Information Sample Number: HBL432-MP-UPL-L5 Includes V Hangers for rapid installation⁽⁶⁾

Quick Ship orders ship in 5 days in order quantities not to exceed 200 pieces.

NOTE: Orders received after noon are entered on the following day.

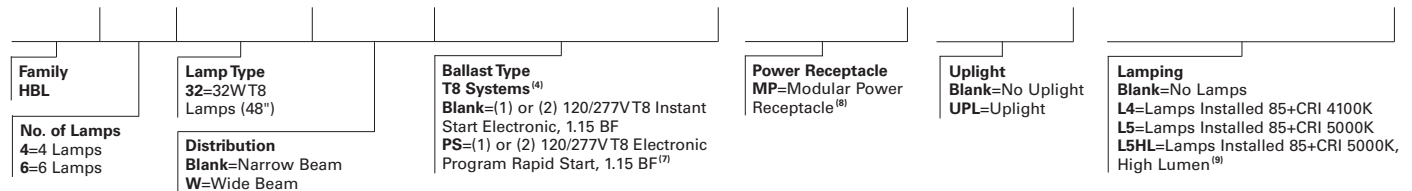

NOTES: ⁽⁷⁾Recommended when using motion sensor options. ⁽⁸⁾Requires use of Modular cord and plug accessories. ⁽⁹⁾L5HL (3000 initial) 5000K T8 lamps installed.