

COOPER LIGHTING - METALUX®

DESCRIPTION

The HBL series is ideal for high mounting height industrial or retail applications. Advanced optical designs provide maximum performance from either T5 or T8 lamps. Optional upright component produces excellent ceiling uniformity. HBL's high lumen package allows the benefits of fluorescent to be applied at high mounting heights that were traditionally exclusive to HID. Benefits include exceptional color rendering, high system efficacy, 95% lumen maintenance, long lamp life, instant on/instant re-strike, economical dimming, and uniform brightness control. Typical HBL applications include retail, shopping malls, light industrial and recreational environments.

SPECIFICATION FEATURES

Construction

Channel and end plates are constructed of die-formed steel. The channel provides strength, numerous KOs for easy installation, and excellent thermal dissipation without any special or proprietary components. Stiffening brackets add additional strength and rigidity to channel and reflectors.

Electrical

The HBL comes with a standard Class "P" electronic ballast and twist-lock lampholders. UL/cUL listed for high ambient environments up to 55°C (131°F) for all lamp and ballast combinations listed. Suitable for damp locations.

Finish

Electrostatically applied baked white enamel finish is preceded by a multistage cleaning cycle, iron phosphate coating with rust inhibitor.

Optics

Die-formed, segmented optical design optimizes performance across three distributions. Optical choices include a narrow distribution for aisles, medium distribution for assembly and loading areas, or wide distribution for general, open area lighting. An upright option is offered to permit ceiling uniformity and allow for ample lamp and luminaire heat dissipation.

Catalog #		Type
Project		
Comments		Date
Prepared by		

Mounting

The HBL series is ideally suited for suspension mounting with optional wire hook and chain set, or cable mounting. Single monopoint mounting is also available with SPM tong hanger. Includes V Hangers for rapid installation.

Warranty

When operated in high ambient conditions, the HBL is supported by a 5 yr/55°C and 3 yr/65°C ballast warranty for T5 and T8 (277V) options when used w/high temperature ballast in open, upright configurations. To maximize your warranty, the HBL should be ordered with a high-temperature ballast in ambient environments that typically exceed 40°C (102°F).



HBL SERIES

ULTRA 47
4, 6, 8, OR 10 T5 LAMPS

High-Bay Industrial Open Luminaire



ENERGY DATA

Input Watts:
EHT Ballast
647=311

Luminaire Efficacy Rating
LER = 83
Catalog Number: HBL-647T5-UPL

Yearly Cost of 1000 lumens,
3000 hrs at .08 KWH = \$2.89

*Reference the lamp/ballast data in the Technical Section for specific lamp/ballast requirements.

**Consult Pre Sales Technical Support.

LAMPS CONTAIN MERCURY. DISPOSE ACCORDING TO LOCAL, STATE OR FEDERAL LAWS

LINEAR DISCONNECT

Safe and convenient means of disconnecting power.



ADF110941 pc
2011-05-17 13:24:26

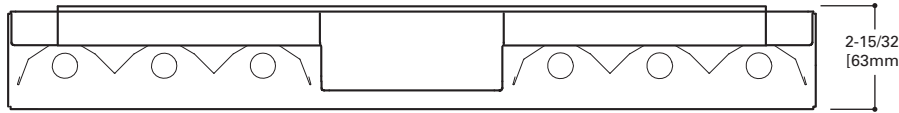

LAMP CONFIGURATIONS

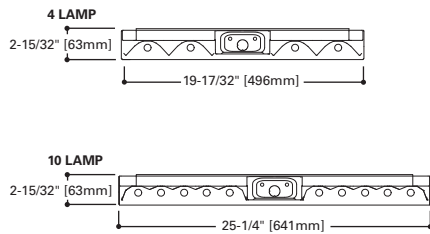

DIMENSION TOP VIEW

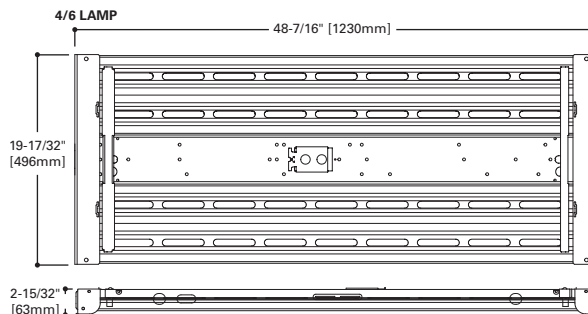

LAMP CONFIGURATIONS

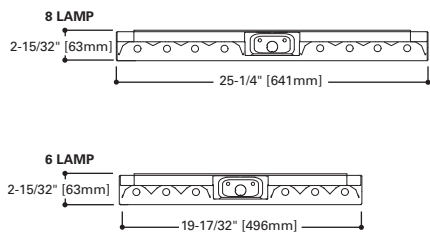

DIMENSION TOP VIEW

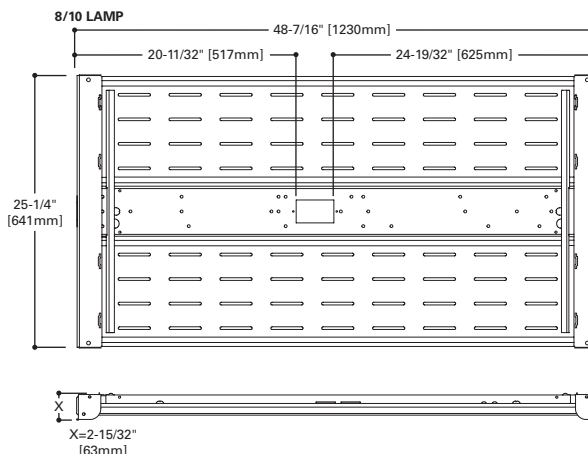

PHOTOMETRICS

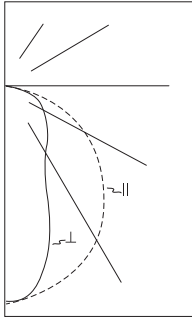

HBL-447T5-UNV-UPL
 (1) Electronic Ballast
 (4) F54T5-47W lamps
 4285 lumens
 Spacing criterion:
 (II) 1.2 x mounting
 height, (L) 0.7 x
 mounting height
 Efficiency 99.3%
 Test Report:
 HBL447.IES
 LER=83
 Yearly Cost of 1000
 lumens, 3000 hrs at
 .08 KWH = \$2.89

Angle	Along II	45°	Across ⊥
0	10037	10037	10037
5	9943	9932	9918
10	9777	9528	9166
15	9525	8737	7664
20	9182	7506	5887
25	8765	6096	4392
30	8274	4733	3681
35	7713	3690	3333
40	7074	3149	2993
45	6389	2771	2738
50	5633	2401	2485
55	4852	2105	2226
60	4038	1820	2144
65	3183	1544	1882
70	2312	1389	1286
75	1471	901	645
80	734	347	106
85	169	2	0
90	4	2	5

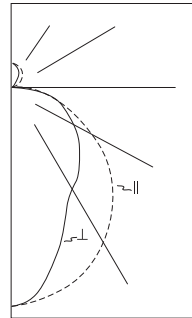

HBL-647T5-UNV-UPL
 (2) Electronic Ballasts
 (6) F54T5-47W lamps
 4285 lumens
 Spacing criterion:
 (II) 1.2 x mounting
 height, (L) 0.8 x
 mounting height
 Efficiency 99.5%
 Test Report: HBL647-
 UPL.IES
 LER=83
 Yearly Cost of 1000
 lumens, 3000 hrs at
 .08 KWH = \$2.89

Angle	Along II	45°	Across ⊥
0	10884	10884	10884
5	10787	10710	10658
10	10619	10181	9795
15	10352	9367	8645
20	9987	8378	7522
25	9548	7412	6483
30	9020	6452	5883
35	8422	5591	5653
40	7746	5046	5208
45	7008	4716	4666
50	6218	4186	4322
55	5369	3594	3911
60	4493	3175	3492
65	3565	2683	3023
70	2615	2204	2632
75	1693	1788	2037
80	854	1224	1431
85	235	596	599
90	3	37	39

Coefficients of Utilization

rc	Effective floor cavity reflectance																	
	80%			70%			50%			30%			10%			0%		
rw	70	50	30	70	50	30	70	50	30	70	50	30	70	50	30	0		
RCR																		
0	118	118	118	118	115	115	115	115	110	110	110	106	106	106	101	101	101	99
1	109	105	101	98	107	103	99	96	99	96	93	95	93	90	91	90	88	86
2	100	93	87	82	98	91	85	81	88	83	79	84	81	77	82	78	75	73
3	92	83	75	69	90	81	74	69	78	72	68	76	71	66	73	69	65	63
4	85	74	66	60	83	73	65	60	71	64	59	68	63	58	66	61	57	55
5	79	67	59	53	77	66	58	52	64	57	52	62	56	51	60	55	51	49
6	73	61	53	47	72	60	52	47	58	52	46	57	51	46	55	50	46	44
7	69	56	48	42	67	55	48	42	54	47	42	52	46	41	51	45	41	39
8	64	52	44	38	63	51	43	38	50	43	38	49	42	38	47	42	38	36
9	60	48	40	35	59	47	40	35	46	39	35	45	39	35	44	39	34	33
10	57	45	37	32	56	44	37	32	43	37	32	42	36	32	41	36	32	30

Zonal Lumen Summary

Zone	Lumens	%Lamp	%Fixture
0-30	6299	36.7	37.0
0-40	9233	53.9	54.2
0-60	14204	82.9	83.4
0-90	17022	99.3	100.0
0-180	17022	99.3	100.0

Luminance Data

Angle in Deg	Average 0-Deg cd/sm	Average 45-Deg cd/sm	Average 90-Deg cd/sm
45	19774	8576	8474
55	18513	8032	8493
65	16483	7995	9746
75	12438	7619	5454
85	4244	50	50

Coefficients of Utilization

rc	Effective floor cavity reflectance																	
	80%			70%			50%			30%			10%			0%		
rw	70	50	30	70	50	30	70	50	30	70	50	30	70	50	30	0		
RCR																		
0	117	117	117	117	113	113	113	113	107	107	107	101	101	101	95	95	95	93
1	107	102	97	94	103	99	95	91	93	90	87	88	86	83	84	82	80	77
2	97	89	82	76	94	86	80	75	82	77	72	77	73	70	74	70	67	65
3	89	78	70	64	86	76	69	63	72	66	61	69	63	59	65	61	57	55
4	81	70	61	54	78	68	60	54	64	58	52	61	55	51	58	53	49	47
5	75	62	54	47	72	61	53	47	58	51	45	55	49	44	53	47	43	41
6	69	56	48	41	67	55	47	41	53	45	40	50	44	39	48	43	38	36
7	64	51	43	37	62	50	42	36	48	41	36	46	40	35	44	39	34	32
8	60	47	39	33	58	46	38	33	44	37	32	42	36	31	41	35	31	29
9	56	43	35	30	54	42	35	30	41	34	29	39	33	29	38	32	28	26
10	53	40	32	27	51	39	32	27	38	31	27	36	30	26	35	30	26	24

Zonal Lumen Summary

Zone	Lumens	%Lamp	%Fixture
0-30	7212	28.0	28.2
0-40	11157	43.4	43.6
0-60	18599	72.3	72.7
0-90	23829	92.7	93.1
0-180	25586	99.5	100.0

Luminance Data

Angle in Deg	Average 0-Deg cd/sm	Average 45-Deg cd/sm	Average 90-Deg cd/sm
45	21690	14596	14441
55	20485	13713	14922
65	18461	13894	15654
75	14315	15119	17224
85	5901	14966	15041

Modular F-Bay Power Supply Option

Cooper Lighting's F-Bay Modular Power Supply option is available for use with all F-Bay products. The modular power supply allows external fixture access for safe and easy servicing. There is no need to remove lamps or reflectors to disconnect fixture power with F-Bay Modular Power Supply. Access to the individual fixture's power supply allows servicing without turning off all the fixtures, disrupting occupants. F-Bay Modular Power Supply is a time-saver in installation – **simply plug & power.**



1. Modular Power Supply Receptacle supplied mounted into fixture Access Plate
2. Modular Power Cord & Plugs in 120, 277, 347, & 480V configurations for easy plug & power into existing supply

No internal fixture access required for installation or disconnecting power

Modular Motion Sensor Option supplied with Mounting Box and Modular Power Supply Receptacle

Code Compliance

- UL/cUL Certified for Make/Break under load (UL2549)
- Meets NEC requirements for ballast disconnect (NEC 410.73G)
- Allows for addition of Occupancy Sensor without hard connections
- Receptacles complete with insulating/dust cap

ORDERING INFORMATION

SAMPLE NUMBER: HBL-647T5-N-UNV-EHT-UPL-U

Series HBL=Linear High Bay	Voltage⁽¹⁾ UNV=Universal 120/277 Voltage 120V=120 Volt 277V=277 Volt	Ballast Type T5 Systems EHT =T5HO Linear Electronic Program Rapid Start High Ambient. ⁴ Total Harmonic Distortion < 10% No. of Ballast 1, 2 or 3	Options UPL=Uplight Apertures on Reflector MP=Modular Power Receptacle (Used for all Cord or Cord and Plug options) ³ MWS=Modular Wiring System⁶ MS=360° or 180° Motion Sensor installed (120V through 347V or 480V) ²	Packaging U=Unit Pack PALC=Job Pack In Carton PAL=Job pack Out of Carton
No. of Lamps 4=4 Lamps 6=6 Lamps 8=8 Lamps 10=10 Lamps	Lamps Installed ⁵ L5841=T5HO Lamp, 85CRI 4100K L5850=T5HO Lamp, 85CRI 5000K GL=Single Element Fuse GM=Double Element Fuse EL=Emergency Installed ¹	Accessories (order separately) HB-SPM =Single Monopoint Hanger w/Hub RH-1=Retrofit Hanger FH-1=Fixture Hook FL-1=Fixture Loop Y- TOGGLE=Y Mounting Toggle, #2 Cable (Specify 10' or 30' - Requires 2 per fixture) ⁷ HBAYC-CHAIN/SET/U=(2) V-Hook Hangers, 36" ChainSets w/S-Hooks MC3=3' Modular Power Cord MPC3=3' Modular Power Cord & Plug (Specify Voltage) MC6=6' Modular Power Cord MPC6=6' Modular Power Cord & Plug (Specify Voltage) MMS=360° or 180° Aisle Motion Sensor with Modular Power Receptacle (120-277V) MDS6=6' Modular Power Cord with MWS 27DS18/2G06MP Connector ⁸ WG/HBL6-4FT-B=4/6 Lamp w/Lamp Wireguard w/Clips WG/HBL8-4FT-B=8 Lamp w/Lamp Wireguard w/Clips		
Lamp Type 47T5=47W T5HO Lamp (48" Long)				
Distribution N=Narrow Beam (Standard) M=Medium Beam W=Wide Beam				

NOTES:

- 1 Voltage must be specified when ordered with plugs or emergency ballasts.
- 2 When ordering MS option, specify as UNV (for 120 or 277V).
- 3 Requires use of MC or MPC cord accessories, specify voltage for plugs.
- 4 EHT/HT5/HCT5 ballast systems suitable for ambient environments not to exceed 149°F (65°C) in open upright configurations and less lens option.
- 5 Must specify lamps when ordering.
- 6 Cannot be combined with Modular Power Receptacle (MP).
For MWS with MP, choose MP in fixture logic and then choose MWS.
- 7 Two required.
- 8 For MWS with MP, choose MP in the fixture logic and then choose MWS accessory such as MDS6.

SHIPPING DATA

Catalog No.	Wt.
HBL-647T5-UNV-UPL	16 lbs.