



SignPRO

SIGNPRO MAG ELE SIGN BAL (4-6) T12HO 8-48FT 120-277V

Philips Advance signPRO line...a brand synonymous with full-line, high-quality sign ballasts offered exclusively to the sign industry to support the market's broad range of sign applications, now adds: ...four new energy-efficient signPRO Electronic Fluorescent Sign Ballasts for T8/HO and T12/HO High Output (800mA) Lamps. Philips Advance signPRO line...a brand synonymous with full-line, high-quality sign ballasts offered exclusively to the sign industry to support the market's broad range of sign applications, now adds: ...four new energy-efficient signPRO Electronic Fluorescent Sign Ballasts for T8/HO and T12/HO High Output (800mA) Lamps.

Product data

General Information	
Lamp Type	T12/HO
Number of Lamps	4-6 piece/unit
Lamp Footage	8 - 48 FT
Ballast Type	Electronic Fluorescent
Base Model	ISB084846E1
Suitable For Outdoor Use	Yes
Automatic Restart	Yes
Operating and Electrical	
Input Voltage	120 to 277 V
Input Frequency	50 to 60 Hz
Max THD	10 %
Starting Method	Instant Start
Lamp Current Crest Factor (Nom)	1.7
Ignition Time (Nom)	0.1 s
Ballast Factor (Nom)	0.60
Power Factor (Nom)	0.98

Input Current (Operating) (Nom)	3.40 A
Input Power (Nom)	390-384 W
Rated Lamp Watts	110 W
Wiring	
Wire Striplength	0.50/0.375 mm
Lamp Connection	Parallel
Wire Length by Color	See data sheet
Wire Gauge (Nom)	18AWG mm
Wire Type	Solid
Remote Wiring Configuration Allowed	No
Tandem Wiring Configuration Allowed	No
Through Wiring Configuration Allowed	Yes
Max Ballast-Lamp Distance Remote Wiring	No Remote
Max Ballast-Lamp Distance Tandem Wiring	No Tandem
Max Ballast-Lamp Distance Through Wiring	Any = 20'

Mechanical and Housing

Housing Material	Metal
Housing	BL2
Housing Dimensions	14.31" x 3.19" x 2.63"

Approval and Application

EMC Immunity Standard	FCC Non-Consumer
Approbation Marks	CSA certificate UL certificate RoHS Compliant
Sound Rating	A
UL Recognized	No

Product Data

Order product name	SIGNPRO MAG ISB084846EI
EAN/UPC - Product	781087135792
Order code	ISB084846EI
Numerator - Quantity Per Pack	1
Numerator - Packs per outer box	1
Material Nr. (12NC)	913701262401
Net Weight (Piece)	6.337 kg

Dimensional drawing

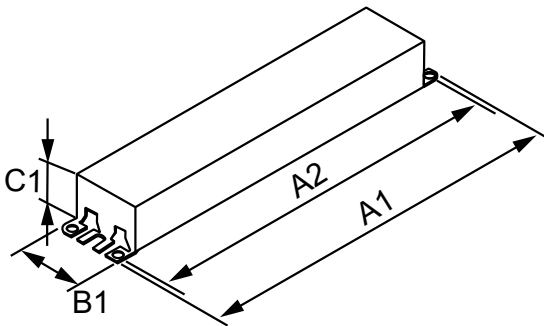

ELE SIGN BAL (4-6) T12HO 8-48FT 120-277V

Product	A1	A2	B1	C1
SIGNPRO MAG ISB084846EI	14.31 in	13.75 in	3.19 in	2.63 in

