

KT-ALED140-M1-X-NM-8XX-VDIM

LED AREA LIGHT FIXTURES

DESCRIPTION

Compact 140W High-Performance LED Area Light |
 120–277V Input | Bronze Housing |
 Multiple Mounting, Optics, and Control options

APPLICATION

Pole-mount or structure-mount outdoor illumination needs (including parking lots, auto dealerships, pathways, roadways, recreational venues, and other general area lighting requirements)



PRODUCT FEATURES

- Compact, low-profile design delivers high-performance illumination and improves application site aesthetics
- Heavy-duty, die-cast aluminum housing with ample heat sinking for enhanced thermal performance
- True U0 design for Dark Sky compliant performance eliminates undesirable sky glow
- Integrated NEMA/ANSI C136.10 3-pin twist-lock receptacle with shorting cap, standard on all fixtures, simplifies ordering requirements for photo control needs
- Precision-crafted optics, available with type II, III, IV, and V patterns, to meet diverse requirements from general purpose to specification-grade applications
- Integral latch design for hassle-free, hinged access to driver compartment
- Four contractor-friendly mounting options available (sold separately): slip fitter mount, adjustable pole mount for square and round poles, fixed pole mount for square and round poles, and trunnion mount
- Bi-level occupancy sensor and twist-lock photocell accessories available
- Reversible glare shield available, suitable for backside (house-side) or frontside (street-side) shielding
- Powered by Keystone 0–10V dimming LED driver featuring 12V AUX power tap, 6kV surge protection
- Ambient operating temperature: –40°C/–40°F to 50°C/122°F
- UL Certified for wet locations, IP65
- 0–10V dimming, 10% min
- Power factor: >0.95
- THD: <20%
- LED chip lifetime: L70 >100,000 hrs @ 25°C/77°F ambient fixture temp
- Meets FCC Part 15, Part B, Class A standards for conducted and radiated emissions

ELECTRICAL SPECIFICATIONS

Catalog Number	Wattage	Lumens	Efficacy	Dimming	Color Temp	CRI	Dist Type*	Input Voltage	Rated Life	Legacy Equivalent	Housing Color**	Additional Feature
KT-ALED140-M1-3-NM-840-VDIM	140W	19,320 lm	138 lm/W	0–10V	4000K	>80	III	120–277V	50,000 hrs	400W	Bronze	10kV external surge protection included
KT-ALED140-M1-3-NM-850-VDIM		19,600 lm	140 lm/W		5000K		III					
KT-ALED140-M1-5-NM-840-VDIM		19,460 lm	139 lm/W		4000K		V					
KT-ALED140-M1-5-NM-850-VDIM		19,740 lm	141 lm/W		5000K		V					

* Fixtures with Type 2 (II) and Type 4 (IV) optics are available and assembled to order. Lead times may apply. Please see catalog number breakdown for full ordering code details.

** Fixtures (and mounts) with alternate housing colors are available and made to order. Extended lead times apply. Please see catalog number breakdown for full ordering code details.

KT-ALED140-M1-X-NM-8XX-VDIM
LED AREA LIGHT FIXTURES

MOUNTING BRACKET OPTIONS (SOLD SEPARATELY)

SLIP FITTER MOUNT

Fits 2 3/8" tenon; Bronze

Catalog Number	UPC	Easy Code
KT-ALED-SF-1-KIT	843654131641	JRH-74

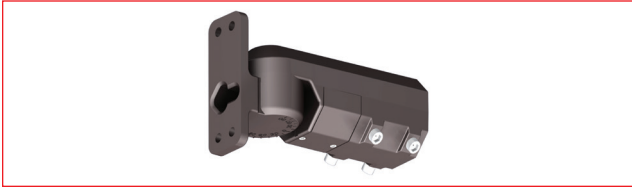

ADJUSTABLE POLE MOUNT

For round or square pole; Bronze

Catalog Number	UPC	Easy Code
KT-ALED-PMA-1-KIT	843654131634	DAQ-87

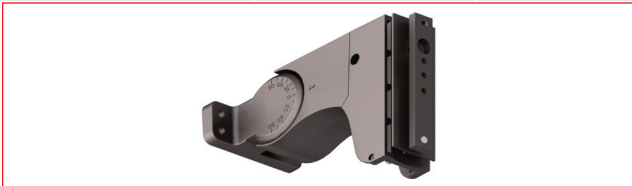

FIXED POLE MOUNT

For round or square pole; Bronze

Catalog Number	UPC	Easy Code
KT-ALED-PM-1-KIT	843654131627	QVG-29



TRUNNION MOUNT

Bronze

Catalog Number	UPC	Easy Code
KT-ALED-TM-1-KIT	843654131658	GTH-37

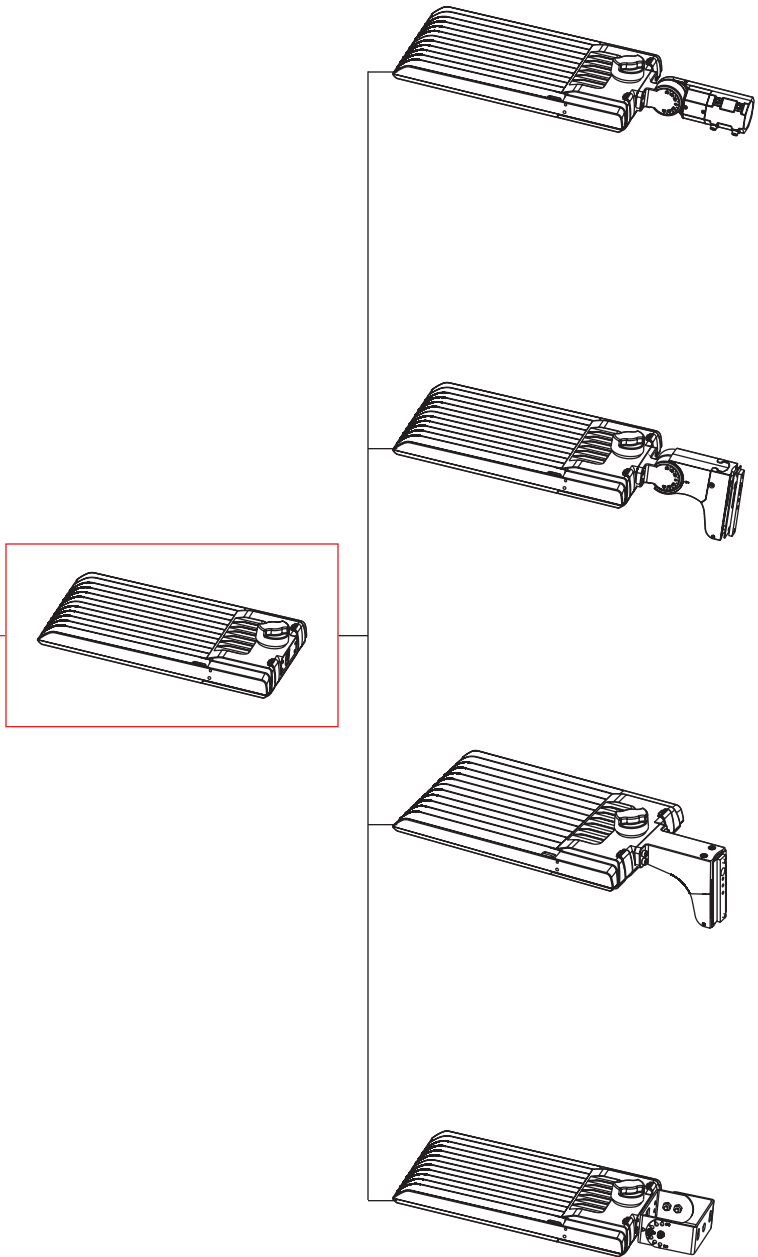
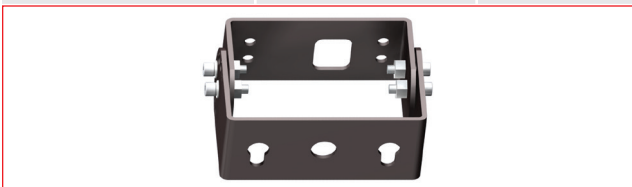



KT-ALED140-M1-X-NM-8XX-VDIM

LED AREA LIGHT FIXTURES

PHYSICAL SPECIFICATIONS

LED AREA LIGHT FIXTURE

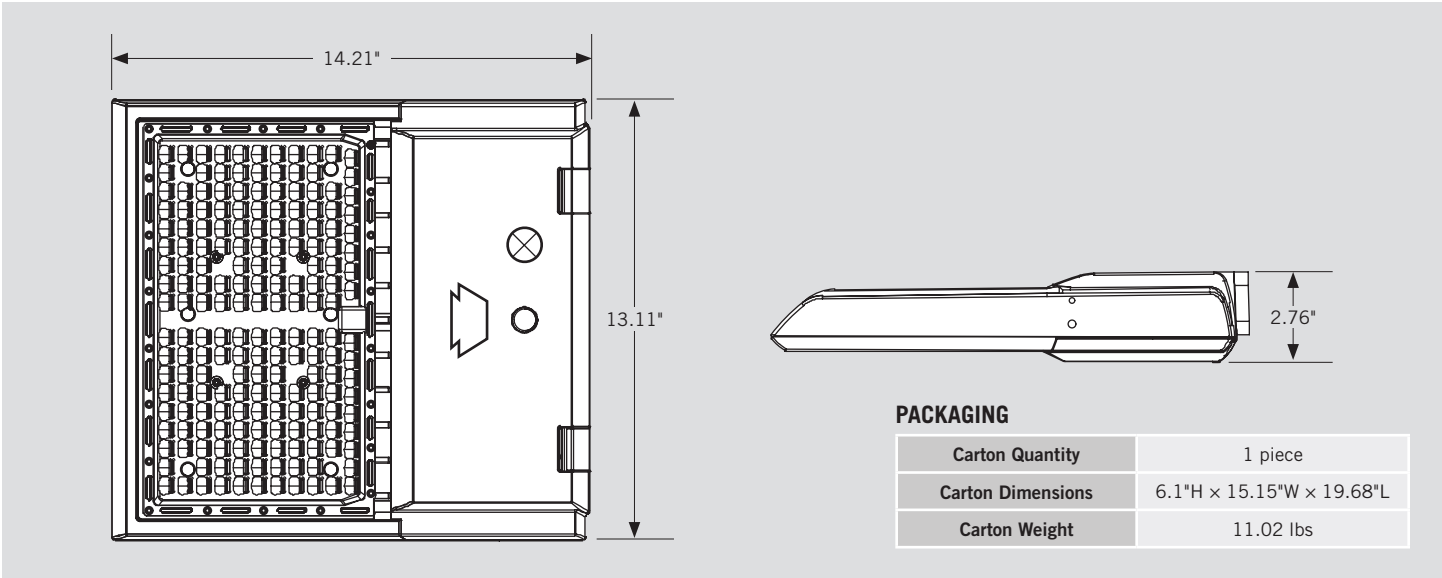

PACKAGING

Carton Quantity	1 piece
Carton Dimensions	6.1\"H x 15.15\"W x 19.68\"L
Carton Weight	11.02 lbs

POLE MOUNT (ADJUSTABLE OR FIXED) DRILLING HOLES

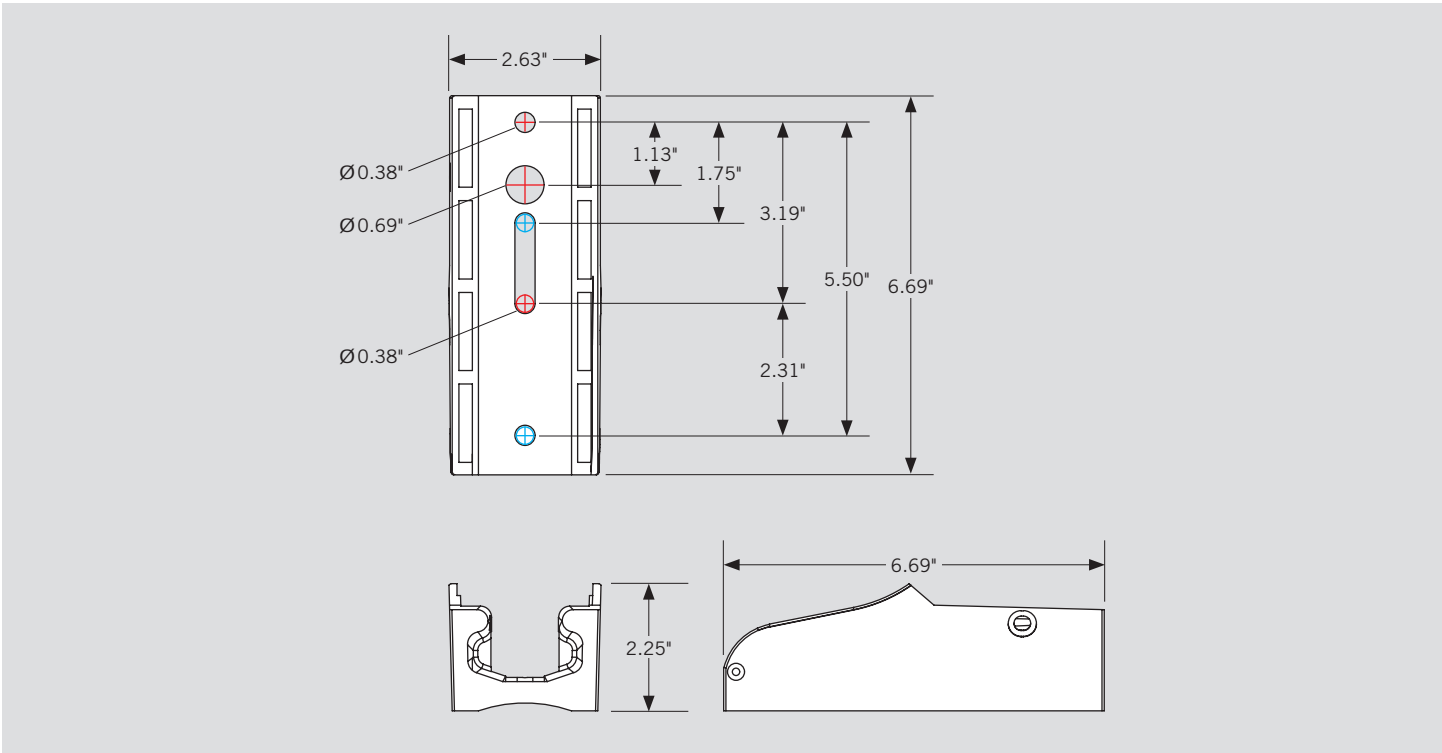



KT-ALED140-M1-X-NM-8XX-VDIM

LED AREA LIGHT FIXTURES

WIRING DIAGRAM

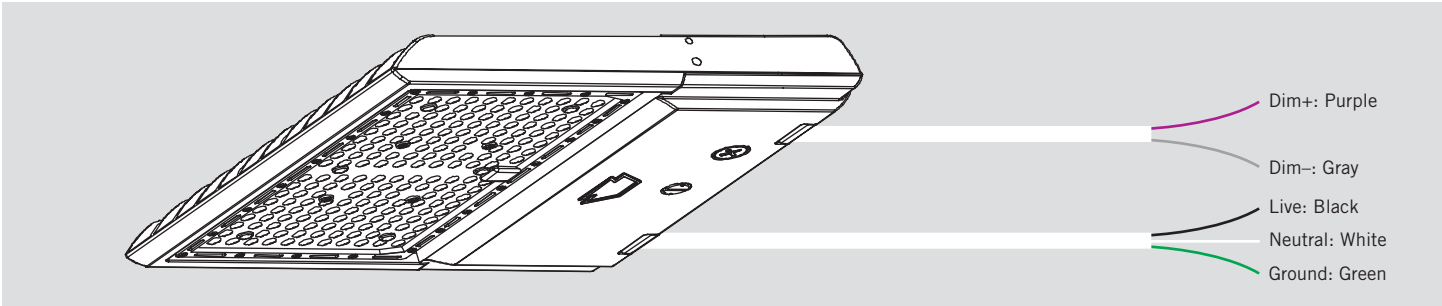

LIGHT DISTRIBUTION PATTERN

TYPE 3 (III)

Pole-mount view from above; Area light mounted at 30'

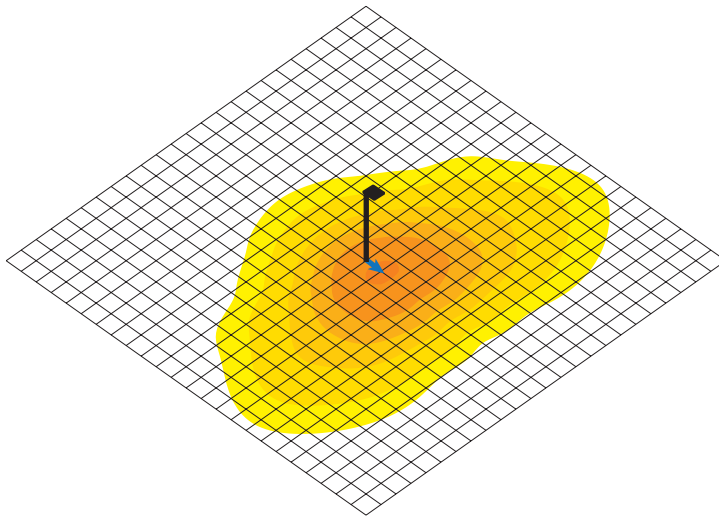

TYPE 5 (V)

Pole-mount view from above; Area light mounted at 30'

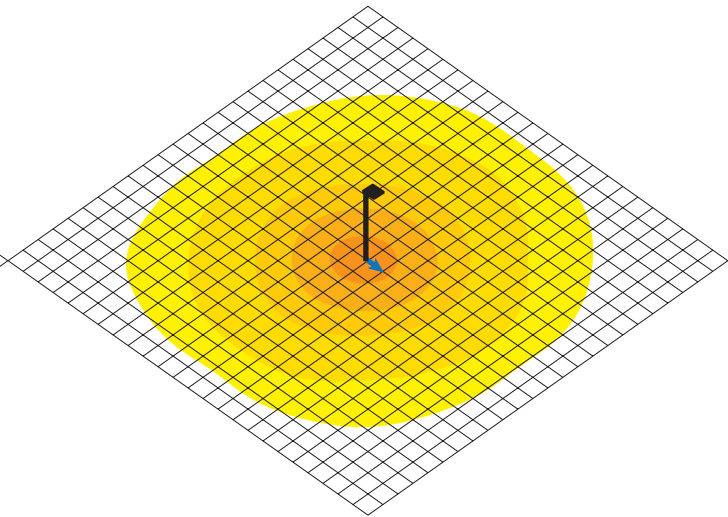

- Photometric layout for general reference only
- Grid dimension: 10 x 10 sq ft

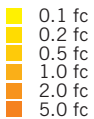

- Photometric layout for general reference only
- Grid dimension: 10 x 10 sq ft

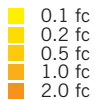

KT-ALED140-M1-X-NM-8XX-VDIM
LED AREA LIGHT FIXTURES

PHOTOMETRIC SPECIFICATIONS (TYPE 3 [III])

ISOCANDELA PLOT

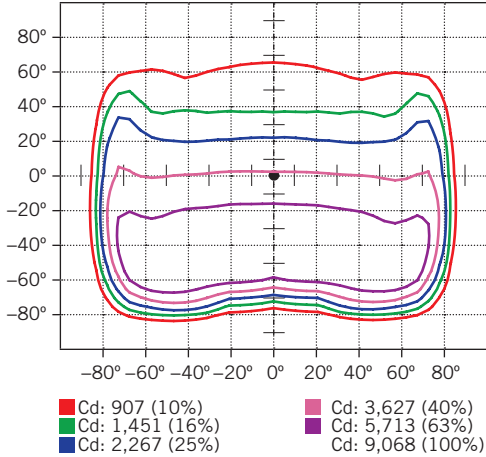

LUMINOUS INTENSITY DISTRIBUTION

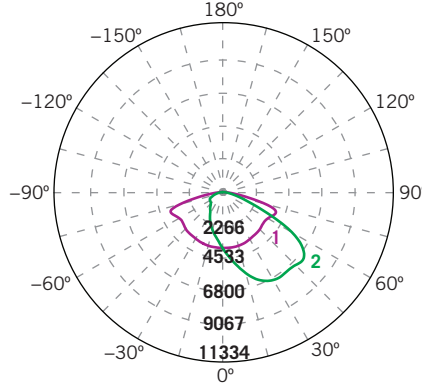

Average diffuse angle (50%): **110.8°**
1 Violet C0-C180
2 Green C90-C270
 Unit: cd

FLUX DISTRIBUTION

Zone	Lumens	% Luminaire
Forward Light	15,114 lm	77.8%
0°-30°	2,165 lm	11.2%
30°-60°	7,491 lm	38.6%
60°-80°	5,044 lm	26.1%
80°-90°	414 lm	2.1%
Back Light	4,301 lm	22.2%
0°-30°	1,151 lm	5.9%
30°-60°	1,961 lm	10.1%
60°-80°	1,090 lm	5.6%
80°-90°	98 lm	0.5%
Up Light	0 lm	0.0%
90°-100°	0 lm	0.0%
100°-180°	0 lm	0.0%

BUG* Rating	
Asymmetrical Luminaire Types	
Type I, II, III, IV	B3 U0 G3
Quadrilateral Symmetrical Luminaire Types	
Type V, Area Light	B3 U0 G3

* Backlight, Uplight, Glare

PHOTOMETRIC SPECIFICATIONS (TYPE 5 [V])

ISOCANDELA PLOT

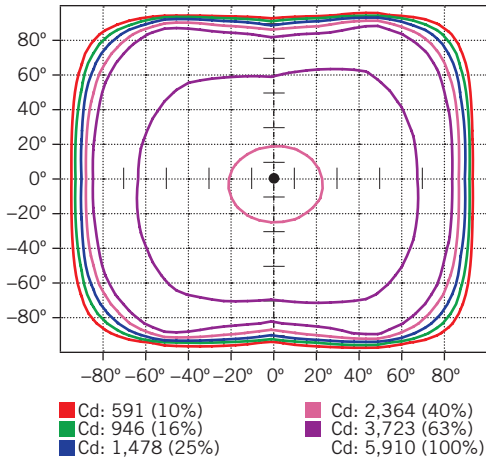

LUMINOUS INTENSITY DISTRIBUTION

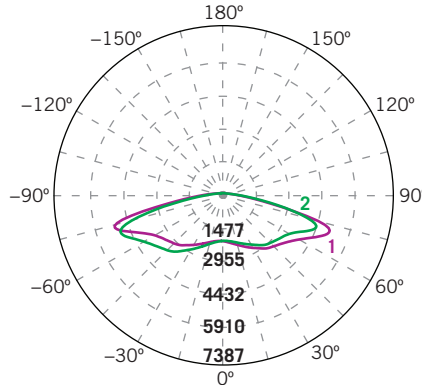

Average diffuse angle (50%): **156.1°**
1 Violet C0-C180
2 Green C90-C270
 Unit: cd

FLUX DISTRIBUTION

Zone	Lumens	% Luminaire
Forward Light	9,388 lm	48.8%
0°-30°	987 lm	5.1%
30°-60°	3,501 lm	18.2%
60°-80°	4,167 lm	21.6%
80°-90°	733 lm	3.8%
Back Light	9,862 lm	51.2%
0°-30°	1,030 lm	5.4%
30°-60°	3,813 lm	19.8%
60°-80°	4,421 lm	23.0%
80°-90°	598 lm	3.1%
Up Light	0 lm	0.0%
90°-100°	0 lm	0.0%
100°-180°	0 lm	0.0%

BUG* Rating	
Asymmetrical Luminaire Types	
Type I, II, III, IV	B4 U0 G4
Quadrilateral Symmetrical Luminaire Types	
Type II	B4 U0 G4

* Backlight, Uplight, Glare

KT-ALED140-M1-X-NM-8XX-VDIM
LED AREA LIGHT FIXTURES

PHOTOMETRIC SPECIFICATIONS (TYPE 4 [IV])

ISOCANDELA PLOT

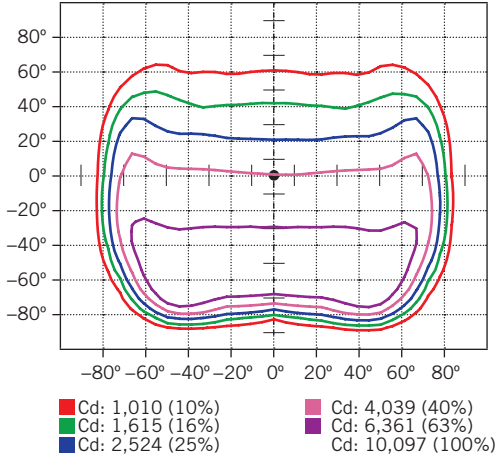

LUMINOUS INTENSITY DISTRIBUTION

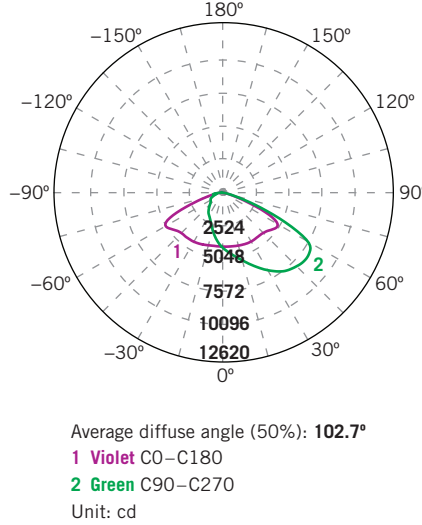

FLUX DISTRIBUTION

Zone	Lumens	% Luminaire
Forward Light	14,983 lm	76.1%
0°-30°	2,124 lm	10.8%
30°-60°	7,670 lm	39.0%
60°-80°	4,963 lm	25.2%
80°-90°	226 lm	1.1%
Back Light	4,707 lm	23.9%
0°-30°	1,258 lm	6.4%
30°-60°	2,314 lm	11.8%
60°-80°	1,030 lm	5.2%
80°-90°	105 lm	0.5%
Up Light	0 lm	0.0%
90°-100°	0 lm	0.0%
100°-180°	0 lm	0.0%

BUG* Rating	
Asymmetrical Luminaire Types	
Type I, II, III, IV	B3 U0 G3
Quadrilateral Symmetrical Luminaire Types	
Type V, Area Light	B3 U0 G3

* Backlight, Uplight, Glare

PHOTOMETRIC SPECIFICATIONS (TYPE 2 [III])

ISOCANDELA PLOT

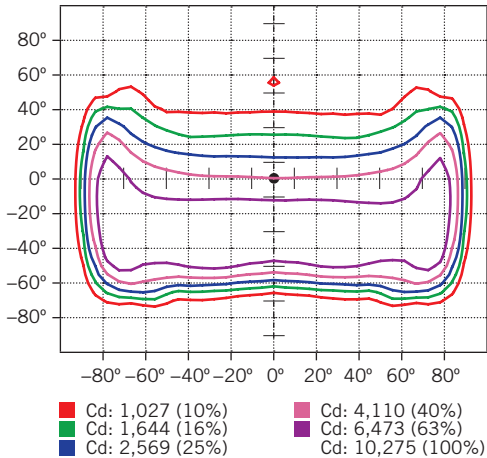

LUMINOUS INTENSITY DISTRIBUTION

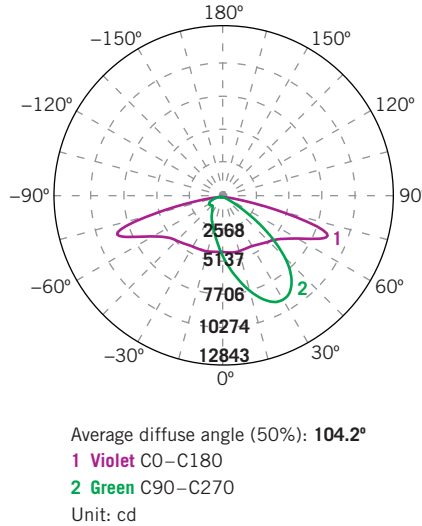

FLUX DISTRIBUTION

Zone	Lumens	% Luminaire
Forward Light	15,217 lm	77.4%
0°-30°	2,778 lm	14.1%
30°-60°	8,524 lm	43.3%
60°-80°	3,698 lm	18.8%
80°-90°	217 lm	1.1%
Back Light	4,446 lm	22.6%
0°-30°	1,126 lm	5.7%
30°-60°	1,921 lm	9.8%
60°-80°	1,318 lm	6.7%
80°-90°	82 lm	0.4%
Up Light	0 lm	0.0%
90°-100°	0 lm	0.0%
100°-180°	0 lm	0.0%

BUG* Rating	
Asymmetrical Luminaire Types	
Type I, II, III, IV	B3 U0 G3
Quadrilateral Symmetrical Luminaire Types	
Type V, Area Light	B3 U0 G2

* Backlight, Uplight, Glare















KT-ALED140-M1-X-NM-8XX-VDIM

LED AREA LIGHT FIXTURES

EPA SPECIFICATIONS

Medium-Size Fixture Housing

Conditions: Horizontal winds only for calculations. Worst case total projected area used for calculations. All drag coefficients are set as worst case 1.2. For details on exact EPA calculations and assumptions, please contact productsupport@keystonetech.com

EPA Calcs (1.2*ft ² View)		Single Fixture	2 Fixtures at 90°	2 Fixtures at 180°	3 Fixtures at 90°	3 Fixtures at 120°	4 Fixtures at 90°	2 Fixtures Side-by-Side	3 Fixtures Side-by-Side	4 Fixtures Side-by-Side
Mounting Application	Fixture Position									
Adjustable Pole Mount 	Horizontal	0.50 sq. ft.	0.78 sq. ft.	1.01 sq. ft.	1.19 sq. ft.	1.28 sq. ft.	1.19 sq. ft.	0.74 sq. ft.	1.11 sq. ft.	1.48 sq. ft.
Adjustable Pole Mount 	45°	1.27 sq. ft.	1.73 sq. ft.	1.27 sq. ft.	2.20 sq. ft.	3.10 sq. ft.	2.20 sq. ft.	2.53 sq. ft.	3.80 sq. ft.	5.07 sq. ft.
Slip Fitter Mount 	Horizontal	0.48 sq. ft.	0.87 sq. ft.	0.97 sq. ft.	1.30 sq. ft.	1.37 sq. ft.	1.30 sq. ft.	0.86 sq. ft.	1.30 sq. ft.	1.73 sq. ft.
Slip Fitter Mount 	45°	1.34 sq. ft.	1.80 sq. ft.	1.34 sq. ft.	2.28 sq. ft.	3.06 sq. ft.	2.28 sq. ft.	2.67 sq. ft.	4.01 sq. ft.	5.35 sq. ft.
Slip Fitter Mount 	Vertical	1.76 sq. ft.	2.25 sq. ft.	1.76 sq. ft.	2.73 sq. ft.	2.94 sq. ft.	2.73 sq. ft.	3.53 sq. ft.	5.29 sq. ft.	7.06 sq. ft.

KT-ALED140-M1-X-NM-8XX-VDIM

LED AREA LIGHT FIXTURES

ACCESSORIES (SOLD SEPARATELY)

TWIST-LOCK AREA LIGHT CONTROL

Catalog Number	Description	UPC	Easy Code
KT-TLP-UV-3PN	NEMA Type Twist-Lock 3-Pin Photocell 120-277V, 1800VA Max; Blue Housing	843654131825	NQT-46



GLARE SHIELD

Catalog Number	Description	UPC	Easy Code
KT-ALED-GS-M1-KIT	Reversible Glare Shield Kit; Medium (fits "M1" fixture bodies); Bronze Housing	843654131801	DHT-23

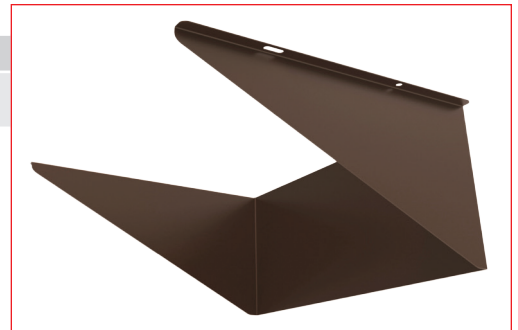

MICROWAVE OCCUPANCY SENSOR

Catalog Number	Description	UPC	Easy Code
KTS-MW3-12V-PKO	12V Microwave Occupancy Sensor	843654130637	TRM-32



REMOTE CONTROL

Catalog Number	Description	UPC	Easy Code
KTS-MW3-REMOTECONTROL	Remote Control for KTS-MW3-12V-XX Sensors, Sets/adjusts all sensor performance parameters	843654132020	XSR-61





KT-ALED140-M1-X-NM-8XX-VDIM

LED AREA LIGHT FIXTURES

ORDERING INFORMATION

ORDER CODE	PACK QTY.	UPC	Easy Code
KT-ALED140-M1-3-NM-840-VDIM	1	843654131405	WCA-01
KT-ALED140-M1-3-NM-850-VDIM	1	843654131412	BOS-17
KT-ALED140-M1-5-NM-840-VDIM	1	843654131429	XWH-36
KT-ALED140-M1-5-NM-850-VDIM	1	843654131436	VBT-79

CATALOG NUMBER BREAKDOWN

KT-ALED140-M1-X-NM-8XX-VDIM

1
2
3
4
5
6
7
8
9
10
11
12
13

- 1** Keystone Technologies
- 2** Fixture Type
- 3** LED Technology
- 4** Wattage
- 5** Size/Shape
- 6** Style/Design Designation
- 7** Distribution Type
- 8** Mounting
- 9** CRI
- 10** Color Temp
- 11** Dimming
- 12** Housing Color
- 13** Options

2 Fixture Type

A	Area Light
----------	------------

5 Size/Shape

M	Medium
----------	--------

6 Style/Design Designation

1	Series 1
----------	----------

7 Distribution Type

2	Type 2 (II)
3	Type 3 (III)
4	Type 4 (IV)
5	Type 5 (V)

8 Mounting

NM	No Mounting
-----------	-------------

9 CRI

8	>80
----------	-----

10 Color Temp

40	4000K
50	5000K

11 Dimming

VDIM	0-10V
-------------	-------

12 Housing Color

Blank	Bronze
B	Black
W	White

13 Options

Blank	No Options
/7PRS	7-Pin Receptacle and Shorting Cap installed
/MW3	Factory-installed Microwave Sensor