



KT-LED27HID-H-EX39-850-D

HID REPLACEMENT LED LAMP

DESCRIPTION

27W HID Replacement LED Lamp | 5000K | 85 CRI | IP64 Rated



LAMP TYPE: HID Replacement LED
BASE TYPE: EX39 (Mogul) Rotatable
WATTAGE: 27W
COLOR TEMPERATURE: 5000K
METAL HALIDE EQUIVALENT: 100W
COLOR RENDERING INDEX (CRI): 85
WARRANTY: 5 Years



PRODUCT FEATURES

- Replacement for Conventional Metal Halide Lamp
- Ideal for Wallpack Retrofit Applications
- Optimized for Horizontal Applications with Directional Light Output from Opening LED Assembly Construction
- Non-Dimmable; Do Not Dim
- 50,000+ Hour Lifetime
- Environmentally Friendly: No Mercury Used
- Instant Startup
- UL Listed
- Operating Temperature: -40°C/-40°F to 45°C/113°F in Enclosed Fixture
- Integral Driver, Eliminates the Need for External Driver or Ballast; Includes 4kV Surge Protection
- IP64 Rated; Integrated Heat Sink Quickly Dissipates Heat and Guides Water Intrusion Out of the Lamp
- Horizontal Orientation
- Suitable for use in fully enclosed fixture. Minimum lamp compartment dimensions: 8in x 8in x 8.7in

OPERATING SPECIFICATIONS

ELECTRICAL CHARACTERISTICS

Input Voltage	Power Consumption	Power Factor	Input Current
120-277Vac	27W	>0.9	0.23A @ 120V 0.10A @ 277V

PHOTOMETRIC CHARACTERISTICS

Color Temperature (CCT)	5000K
Luminous Flux	4100 lm
Color Rendering Index (CRI)	85
Efficacy	152 lm/W
Beam Angle	180°

RATED LIFE

L70 (Hours)	50,000
-------------	--------

SPECTRAL DISTRIBUTION

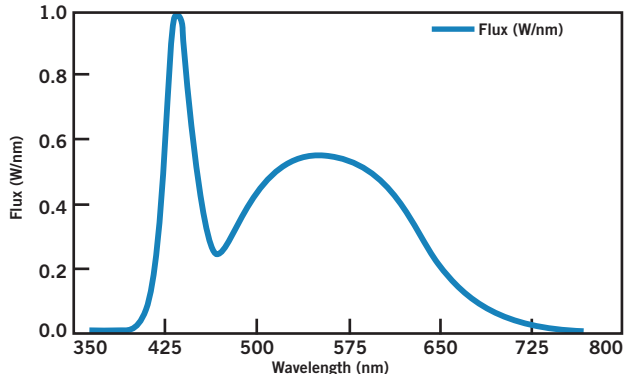

LUX DISTANCE CURVE

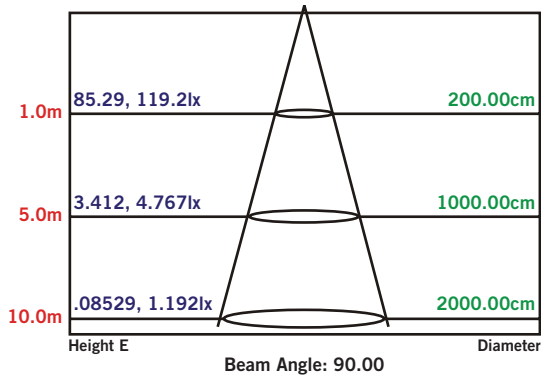



KT-LED27HID-H-EX39-850-D

HID REPLACEMENT LED LAMP

WIRING INSTRUCTIONS

STEP 1

Disconnect power. Disconnect and remove existing ballast, capacitor, and/or ignitor (where applicable) from fixture.

STEP 2

Rewire for line voltage to the lamp socket. Lamp is compatible with 120-277V from single phase, three phase wye, and three phase delta systems.

STEP 3

Install new LED replacement lamp. Ensure lamp is operating properly when power is turned on.

STEP 4

Rotate lamp base and open wings accordingly toward direction of desired lumination.

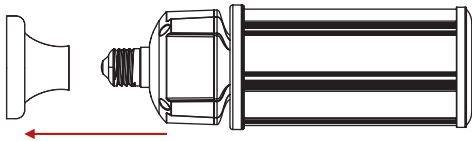

STEP 1

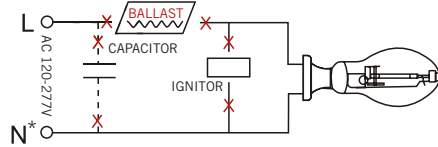

STEP 2

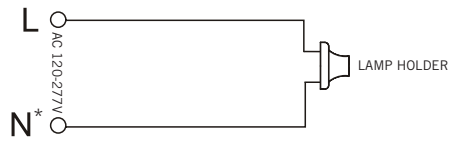

STEP 3

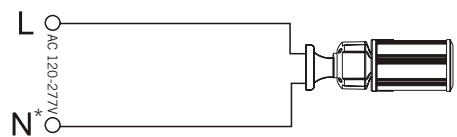

STEP 4

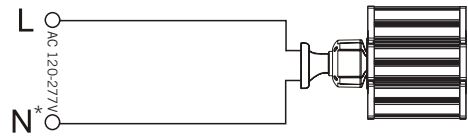

*or other line for certain three phase systems such as 120/208 three phase wye systems

PHYSICAL CHARACTERISTICS

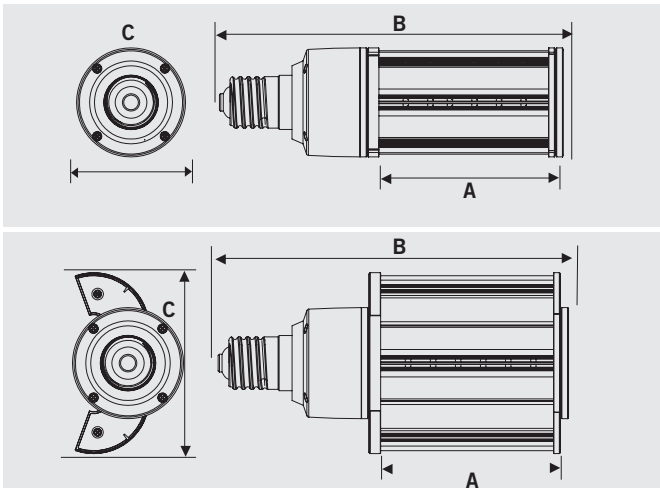

LAMP DIMENSIONS

WINGS CLOSED

A (Illuminated Length)	3.62"
B (Body Length)	8.70"
C (Width)	3.23"

WINGS OPEN

A (Illuminated Length)	3.62"
B (Body Length)	8.70"
C (Width)	5.26"

BASE TYPE: EX39 (Mogul) Rotatable



KT-LED27HID-H-EX39-850-D

HID REPLACEMENT LED LAMP

ORDERING INFORMATION

ORDER CODE	PACK QTY.	EASY CODE	UPC
KT-LED27HID-H-EX39-850-D-DP	16	YIP-46	89094901620

CATALOG NUMBER BREAKDOWN

KT-LED27HID-H-EX39-850-D-DP

1 2 3 4 5 6 7 8 9 10

- 1 Keystone Technologies
- 2 LED Lamp
- 3 Wattage
- 4 Lamp Type
- 5 Horizontal Orientation
- 6 Base Type
- 7 800 Series
- 8 Color Temperature
- 9 DirectDrive Series
- 10 Packaging Style