



# KT-LED7.5T8-24G-8CSJ-X3

## T8 LED LAMP

### DESCRIPTION

7.5W T8 2' LED Lamp | 3000/3500/4000/5000/6500K | >80 CRI | High-Efficiency | Single- or Double-ended Line Voltage Wiring | Ballast and Line-Voltage Compatible



<b>LAMP TYPE:</b> Linear
<b>BULB TYPE:</b> T8 LED
<b>BASE TYPE:</b> G13 (Medium Bi-Pin)
<b>WATTAGE:</b> 7.5W
<b>COLOR TEMPERATURE:</b> 3000/3500/4000/5000/6500K
<b>COLOR RENDERING INDEX (CRI):</b> > 80
<b>WARRANTY:</b> 5 Years

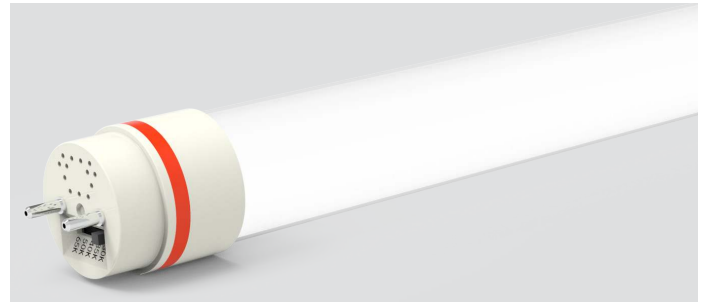

### PRODUCT FEATURES

- Replacement for conventional fluorescent lamp
  - Plug & Play application: Compatible with most instant- and programmed-start electronic T8 ballasts
  - Bypass ballast application: Runs on 120–277 line voltage wired Single- or double-ended
  - Compatible with most instant- and program-start electronic T8 ballasts.
- Contact Keystone for Ballast Compatibility List**
- Keystone Color Select technology (3000/3500/4000/5000/6500K)
  - Instant startup
  - Frosted glass lens eliminates pixelation
  - Approximately 60% more energy-efficient than standard F32T8 lamps
  - Environmentally friendly: No mercury used
  - 135+ Lumens per Watt

- Integral driver (isolated) eliminates the need for external driver or ballast
- Not compatible with fluorescent emergency ballasts or Keystone AC EM drivers; Keystone K1 kits are recommended for emergency applications
- Not rated for use in Vapor Tight style fixtures
- Meets FCC Part 15, Class B
- NSF Listed: NSF/ANSI Standard 2—Food equipment, splash zone (not for direct food zone without additional fixture considerations)
- 50,000+ hour lifetime
- UL Classified
- Lamp is dimmable in Type B mode when used with an appropriate dimming accessory (purchased separately). Contact Keystone for more details to find out what is best for the intended application.
- Dimmable with compatible dimming ballasts (See Compatibility List)

### ELECTRICAL SPECIFICATIONS

CCT	Ballast-Compatible Application				Line-Voltage Application				Max THD	Power Factor	Beam Angle	
	Input Voltage	System Wattage*		Initial Lumens*		Input Voltage	Bare Lamp Wattage	Initial Lumens				Efficacy
		0.78BF	0.88BF	0.78BF	0.88BF							
3000K	Ballast dependent	9.1W	9.4W	950 lm*	1130 lm*	120–277V	7.5W	1100	146 lm/w	20%	>0.9	240°
3500K		9.1W	9.4W	975 lm*	1140 lm*			1150	153 lm/w			
4000K		9.1W	9.4W	985 lm*	1150 lm*			1175	156 lm/w			
5000K		9.1W	9.4W	985 lm*	1140 lm*			1150	153 lm/w			
6500K		9.1W	9.4W	985 lm*	1120 lm*			1150	153 lm/w			

\*Nominal values. Actual values may vary depending on electronic ballast used.

\*\* Preset to 4000K CCT; Color Uniformity: CCT (Correlated Color Temperature) range as per guidelines outlined in ANSI C78.377-2017

# KT-LED7.5T8-24G-8CSJ-X3

## T8 LED LAMP

### ENVIRONMENTAL SPECIFICATIONS

Operating temperature:	-20°C/-4°F to 45°C/113°F
Storage temperature:	-30°C/-22°F to 60°C/140°F
Operating humidity:	10-80%

### COLOR SELECT (CCT) ADJUSTMENT

- This fixture is equipped with field-adjustable Keystone Color Select technology
- Adjustable CCT (3000/3500/4000/5000/6500K).
- Adjust dip switch to desired setting (preset to 4000K CCT).



### PHOTOMETRIC SPECIFICATIONS

#### SPECTRAL DISTRIBUTION

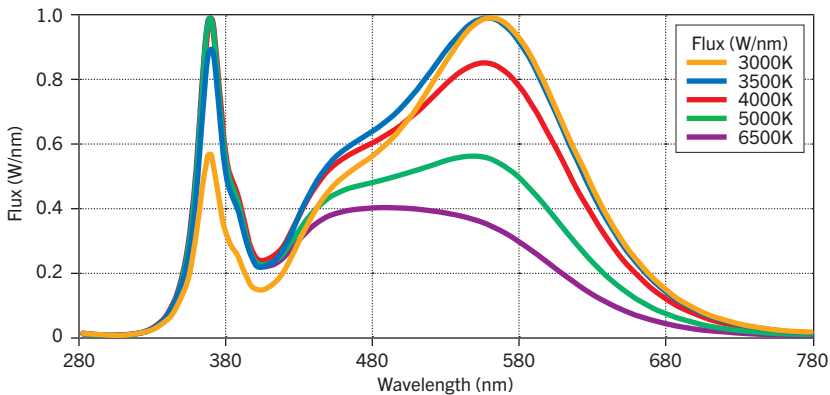

### PHYSICAL SPECIFICATIONS

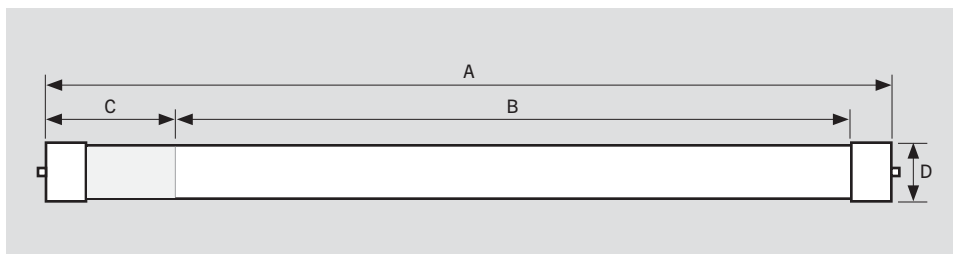

#### LAMP DIMENSIONS

A (Body Length)	23.20"
B (Illuminated Length)	20.20"
C (End Cap/Sticker Area)	2.25"
D (Diameter)	1.10"

**NOMINAL LENGTH: 24"**

**BASE TYPE: G13 (Medium Bi-Pin)**



# KT-LED7.5T8-24G-8CSJ-X3

## T8 LED LAMP

### INSTALLATION INSTRUCTIONS

#### DIRECT REPLACEMENT (WITH EXISTING BALLAST)

1. Turn power off.
2. Remove lens or diffuser, if applicable.
3. Remove existing fluorescent lamp(s) from the luminaire.
4. Install the LED replacement lamp(s), one lamp for each fluorescent lamp removed\*.
5. Replace lens or diffuser back in place, if applicable.
6. Turn power back on.

\* **Warning:** Check Keystone's *Ballast Compatibility List* before installation

#### BY-PASS REPLACEMENT (WITH BALLAST REMOVED)

- A. Disconnect power from fixture.
- B. Remove fluorescent lamps.
- C. Remove lens and wiring compartment, if applicable.
- D. Cut all wires connected to ballast (see **Figure A: Typical Ballast Configurations**).
- E. Identify what type of lamp holders are in fixture: non-shunted lamp holders or shunted lamp holders (see **Figure B: Lamp Holder Types**). Double-ended wiring installations of Keystone Combo Drive X3 tubes can be used with shunted G13 or non-shunted G13 lamp holders with instructions to externally shunt.

**FIGURE A** Typical Ballast Configurations

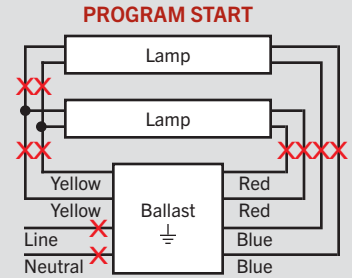

**PREHEAT WITH STARTER**

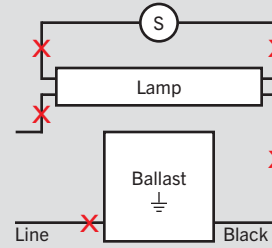

**INSTANT START**

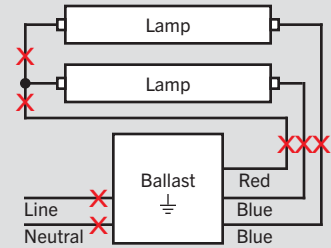

**CAUTION:** Instant start ballasts have shunted lamp holders.

**FIGURE B** Lamp Holder Types

**TYPICAL NON-SHUNTED LAMP HOLDER**

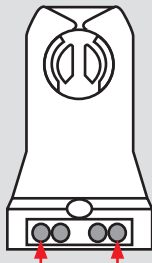

Connect wires directly to these terminals

**TYPICAL SHUNTED LAMP HOLDER**

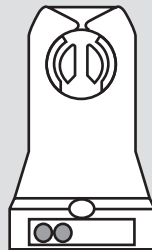

Internal shunt

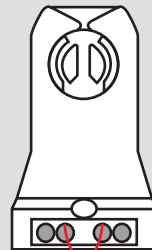

External shunt

**Caution:** For single-ended wiring use *only* non-shunted lamp holders.

For Single-ended wiring, do not install product in a fixture with shunted lamp holders (found in all fixtures using instant start ballasts). If the current lamp holders are shunted, remove them and replace them with non-shunted lamp holders. Make new connections directly to terminals as indicated above.

Keystone can provide any style replacement lamp holders. Call us at 800-464-2680.

**FIGURE C** Direct Drive LED Tube Connection Pins

**SIDE A**

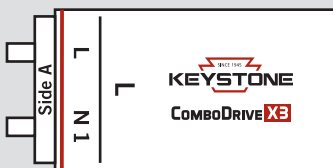

**SIDE B**



# KT-LED7.5T8-24G-8CSJ-X3

## T8 LED LAMP

### WIRING DIAGRAMS

#### DOUBLE-ENDED LINE VOLTAGE WIRING

##### Single lamp

1. Follow steps A–C (see **By-Pass Replacement (with ballast removed)**, on page 2).
2. Cut all existing connections to ballast and remove ballast (see **Figure A**, on page 2, for typical ballast configurations).
3. Connect line voltage AC to both pins on Side A of the lamp (marked L and N1) on the endcap as shown below; on Side B, connect line neutral AC wire to pins marked N2 and N3 on the endcap as shown below (see **Figure C**, on page 2, for Direct Drive LED tube connection pins).

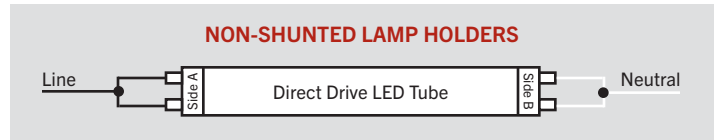
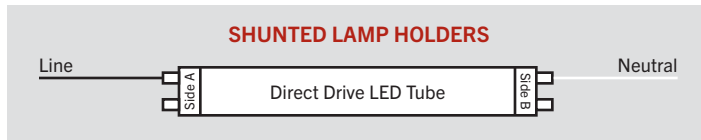

4. Complete all electrical connections with appropriate connectors/wire nuts as needed, per all local and national electrical codes.  
**Note:** there should not be any exposed wires from sockets left unconnected.
5. Replace wiring compartment cover.
6. Ensure that installed lamp is wired to line and neutral in the lamp holder and that lamp is facing proper direction for illumination.
7. Install lens or diffuser, if applicable.
8. Apply power to fixture and check for illumination.

##### Multiple lamps

1. Follow steps A–C (see **By-Pass Replacement (with ballast removed)**, on page 2).
2. Cut all existing connections to ballast and remove ballast (see **Figure A**, on page 2, for typical ballast configurations).
3. Connect the terminals of the first lamp to the matching terminals of the second lamp with line and neutral wires. Continue daisy-chain connection for each additional lamp as shown below.

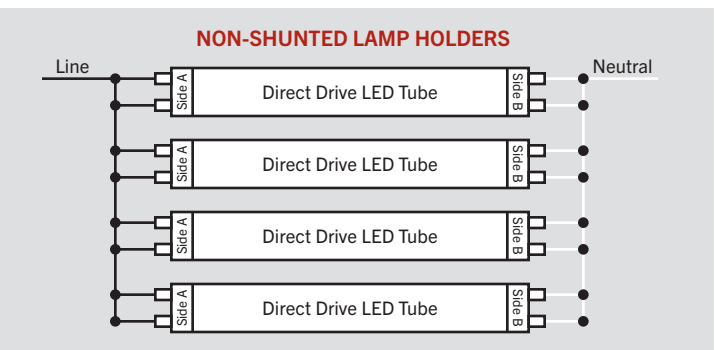
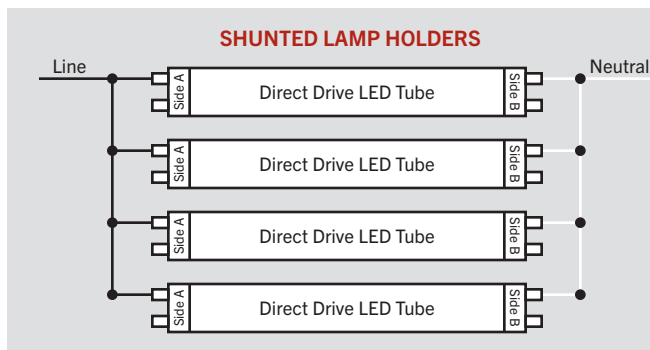

4. Complete all electrical connections with appropriate connectors/wire nuts as needed, per all local and national electrical codes.  
**Note:** there should not be any exposed wires from sockets left unconnected.
5. Replace wiring compartment cover.
6. Ensure that installed lamp is wired to line and neutral in the lamp holder and that lamp is facing proper direction for illumination.
7. Install lens or diffuser, if applicable.
8. Apply power to fixture and check for illumination.

(wiring diagrams continued on next page)

# KT-LED7.5T8-24G-8CSJ-X3

## T8 LED LAMP

### WIRING DIAGRAMS (continued)

#### SINGLE-ENDED LINE VOLTAGE WIRING\*

**Note:** For single-ended wiring installations, power is applied *only* to endcap labeled Side A. Do NOT apply power to Side B.

#### Single lamp

- Follow steps A–C (see **By-Pass Replacement (with ballast removed)**, on page 2).
- Cut all existing connections to ballast and remove ballast (see **Figure A**, on page 2, for typical ballast configurations).  
**Note:** Single-ended wiring requires non-shunted lamp holders (see **Figure B**, on page 2, for lamp holder types).
- On Side A of lamp holder, connect line voltage AC wire to pin marked L and connect line neutral AC wire to pin marked N1 on the endcap as shown below (see **Figure C**, on page 3, for Direct Drive LED tube connection pins). Do not connect AC wires to Side B.

**\*Caution:** Use only non-shunted lamp holders for single-ended wiring installations. Do not perform single-ended wiring installation of product in a fixture with shunted lamp holders (found in all fixtures using instant-start ballasts). If the existing lamp holders are shunted and single-ended wiring is desired, remove and replace them with non-shunted lamp holders (or remove the external shunt, if applicable). Make new connections directly to lamp holder terminals as shown on this page.

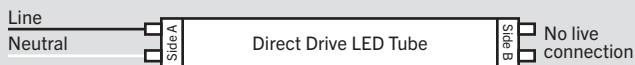

- Complete all electrical connections with appropriate connectors/wire nuts as needed, per all local and national electrical codes.  
**Note:** there should not be any exposed wires from sockets left unconnected.
- Replace wiring compartment cover.
- Ensure that installed lamp is wired to line and neutral in the lamp holder and that lamp is facing proper direction for illumination.
- Install lens or diffuser, if applicable.
- Apply power to fixture and check for illumination.

#### Multiple lamps

- Follow steps A–C (see **By-Pass Replacement (with ballast removed)**, on page 2).
- Cut all existing connections to ballast and remove ballast (see **Figure A**, on page 2, for typical ballast configurations).  
**Note:** Single-ended wiring requires non-shunted lamp holders.
- Connect the terminals of the first lamp to the matching terminals of the second lamp with line and neutral wires. Continue daisy-chain connection for each additional lamp as shown below. **Note:** Do not connect any wires to Side B of lamp holder.

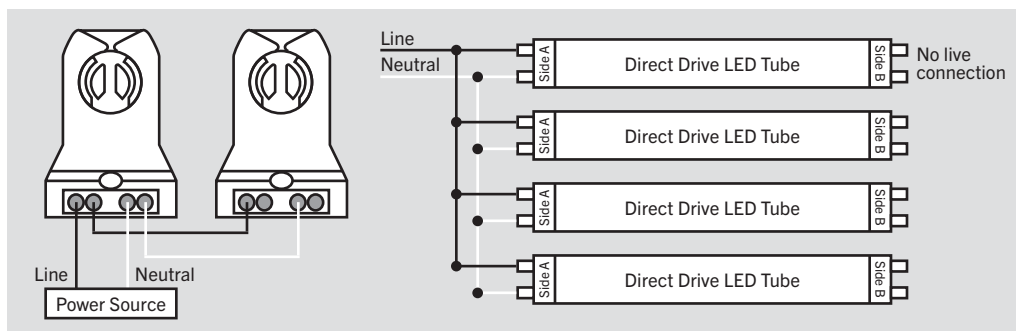

- Complete all electrical connections with appropriate connectors/wire nuts as needed, per all local and national electrical codes.  
**Note:** there should not be any exposed wires from sockets left unconnected.
- Replace wiring compartment cover.
- Ensure that installed lamp is wired to line and neutral in the lamp holder and that lamp is facing proper direction for illumination.
- Install lens or diffuser, if applicable.
- Apply power to fixture and check for illumination.



# KT-LED7.5T8-24G-8CSJ-X3

## T8 LED LAMP

### ORDERING INFORMATION

ORDER CODE	CARTON QUANTITY	UPC	EASY CODE	DLC PRODUCT ID
KT-LED7.5T8-24G-8CSJ-X3	25 pcs	843654156125	OUC-38	TBD

### CATALOG NUMBER BREAKDOWN

# KT-LED7.5T8-24G-8CSJ-X3

- 1
- 2
- 3
- 4
- 5
- 6
- 7
- 8
- 9
- 10

- 1 Keystone Technologies
- 2 LED Lamp
- 3 Wattage
- 4 Lamp Type
- 5 Nominal Length (Inches)
- 6 Glass Construction
- 7 CRI
- 8 Color Select
- 9 Color Select Designation
- 10 Single- or Double-Ended Line Voltage Wiring

<b>9 Color Select Designation</b>	J	3000/3500/4000/5000/6500K
-----------------------------------	---	---------------------------