



KT-LEDXXXPSHID-V-EX39-8CSB-D

HID REPLACEMENT LED LAMP

DESCRIPTION

Power Select + Color Select HID Replacement LED Lamp | 80 CRI



5 YEAR
WARRANTY

LAMP TYPE: HID Replacement LED
BASE TYPE: EX39 (Mogul)
SELECTABLE WATTAGE: 60W - 115W options available
SELECTABLE COLOR TEMPERATURE: 3000/4000/5000K
COLOR RENDERING INDEX (CRI): > 80
WARRANTY: 5 Years

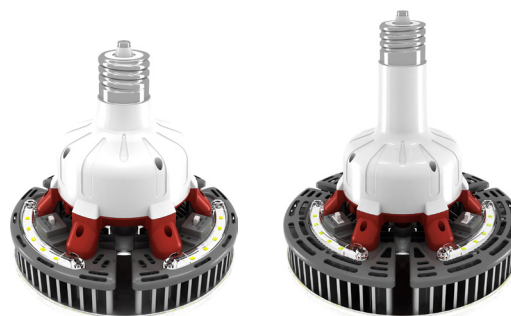

PRODUCT FEATURES

- Keystone Power Select technology (See **Performance Specifications** charts for details)
- Keystone Color Select technology (3000/4000/5000K)
- UL Type B lamp with integrated driver for ballast bypass
- Includes 4kV surge protection
- Instant start up
- Environmentally friendly with no mercury used
- Not suitable for use with dimmers
- Suitable for use in fully enclosed fixtures. See lamp compartment dimensions on page 7
- Suitable for use in damp locations
- 50,000 hour lifetime
- UL 1993 Certified Lamp
- UL 1598C Certified Retrofit Kit
- Operating temperature: -40°C/-40°F - 60°C/140°F

PERFORMANCE SPECIFICATIONS OVERVIEW

Keystone Catalog Number	Selectable Power	Selectable CCT	Lumens	Efficacy	Input Voltage	CRI	Base Type
KT-LED80PSHID-V-EX39-8CSB-D	80/70/60W	3000K 4000K 5000K	11,400/10,150/8,820lm	145 lm/W	120-277V	> 80	EX39
KT-LED115PSHID-V-EX39-8CSB-D	115/95/80W		16,560/13,965/12,160 lm	147 lm/W			EX39

* Color Uniformity: CCT (Correlated Color Temperature) range as per guidelines outlined in ANSI C78.377-2017

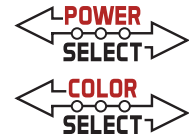

KT-LEDXXXPSHID-V-EX39-8CSB-D

HID REPLACEMENT LED LAMP

PERFORMANCE SPECIFICATIONS DETAILED

Keystone Catalog Number	Selectable Power	Selectable CCT	Lumens	Efficacy	Input Voltage	CRI	Base Type	Smart Port LED
KT-LED80PSHID-V-EX39-8CSB-D	80W	3000K	10,560 lm	132 lm/W	120-277V	> 80	EX39	Compatible
		4000K	11,704 lm	146 lm/W				
		5000K	11,400 lm	143 lm/W				
	70W	3000K	9,590 lm	137 lm/W				
		4000K	10,251 lm	146 lm/W				
		5000K	10,150 lm	145 lm/W				
	60W	3000K	8,340 lm	139 lm/W				
		4000K	8,778 lm	146 lm/W				
		5000K	8,820 lm	147 lm/W				
KT-LED115PSHID-V-EX39-8CSB-D	115W	3000K	15,180 lm	132 lm/W	120-277V	> 80	EX39	Compatible
		4000K	17,136 lm	149 lm/W				
		5000K	16,560 lm	144 lm/W				
	95W	3000K	13,205 lm	139 lm/W				
		4000K	14,352 lm	151 lm/W				
		5000K	13,965 lm	147 lm/W				
	80W	3000K	11,360 lm	142 lm/W				
		4000K	12,166 lm	152 lm/W				
		5000K	12,160 lm	152 lm/W				

* Color Uniformity: CCT (Correlated Color Temperature) range as per guidelines outlined in ANSI C78.377-2017

PRODUCT IMAGES

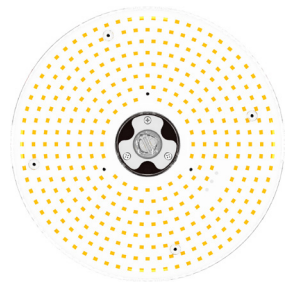
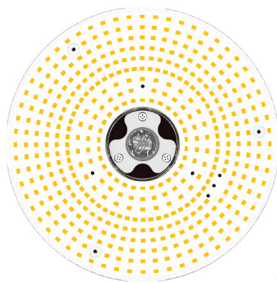

KT-LED80PSHID-V-EX39-8CSB-D

KT-LED115PSHID-V-EX39-8CSB-D

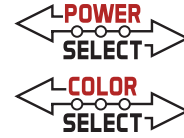

KT-LEDXXXPSHID-V-EX39-8CSB-D

HID REPLACEMENT LED LAMP

POWER SELECT (WATTAGE) AND COLOR SELECT (CCT) ADJUSTMENT

This fixture is equipped with Power Select and Color Select technology.

1. Ensure power is off to the fixture.
2. Adjust dip switches to desired settings.

COLOR SELECT ADJUSTMENT

Set dip switch to adjust CCT between 5000K, 4000K, and 3000K. Fixture comes preset at 5000K.

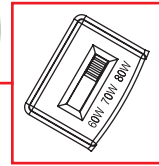
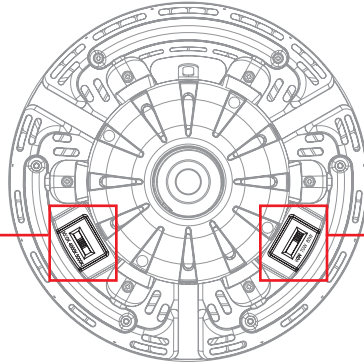
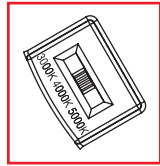

POWER SELECT ADJUSTMENT

Set dip switch to adjust wattage between 60W, 70W, and 80W. Fixture comes preset at 80W.

OPTIONAL SENSOR OR CONTROLLER INSTALLATION INSTRUCTIONS

1. Ensure power is off to the fixture.
2. Use a flat-blade screwdriver to unscrew the 1/2" knock-out; remove knock-out plug.
3. Adjust lamp to maximum wattage (115W) to avoid abnormal sensor behavior (see **Power Select and Color Select Adjustment**).
4. Screw in sensor or controller and hand-tighten it.
5. Re-connect power when ready.

Note: MW3 and PIR3 sensors can be controlled with KTS-MW3-REMOTECONTROL (sold separately).

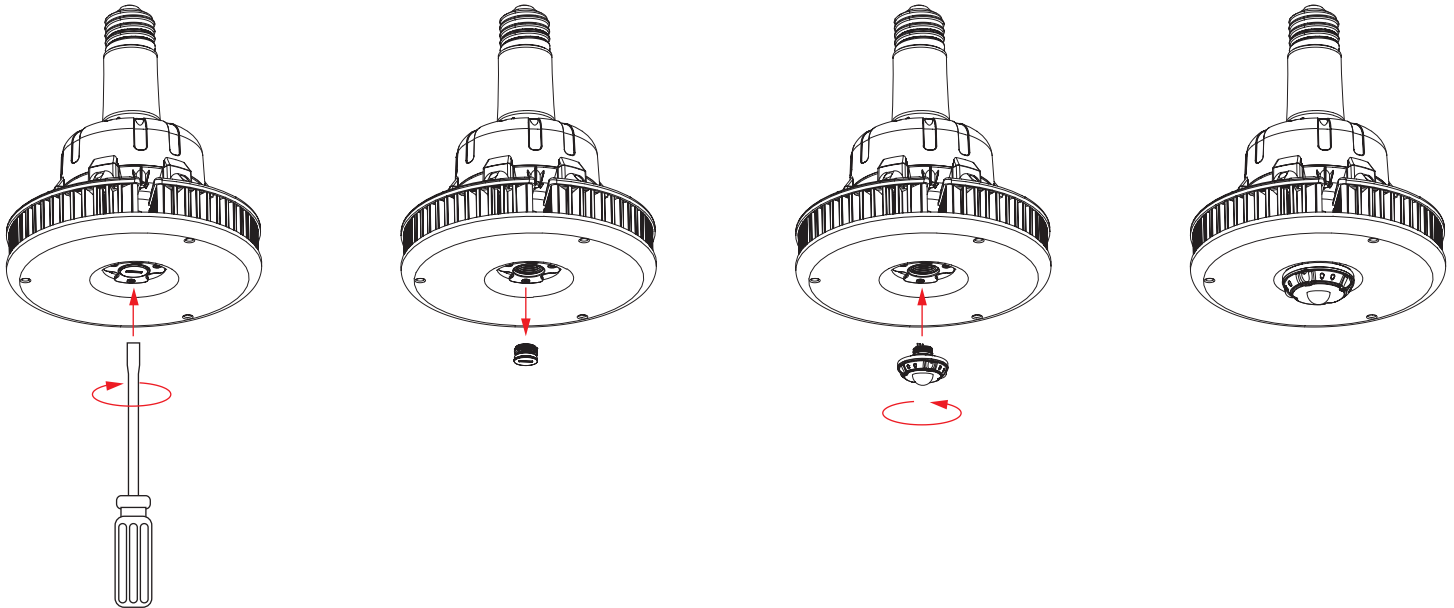

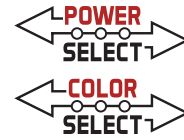

KT-LEDXXXPSHID-V-EX39-8CSB-D

HID REPLACEMENT LED LAMP

WIRING SPECIFICATIONS

STEP 1

Disconnect power. Disconnect and remove existing ballast, capacitor, and/or ignitor (where applicable) from fixture.

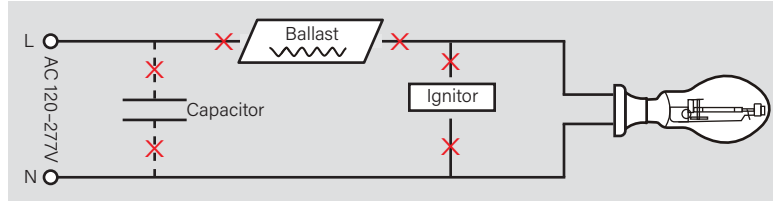

STEP 2

Rewire for line voltage to the lamp socket.

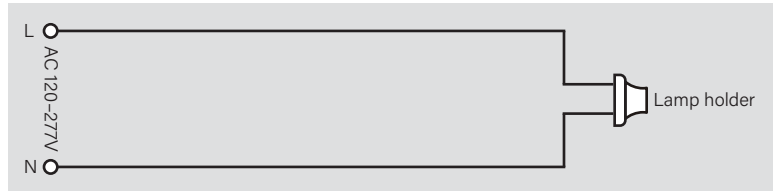

STEP 3

Install new LED replacement lamp. Ensure lamp is operating properly when power is turned on.

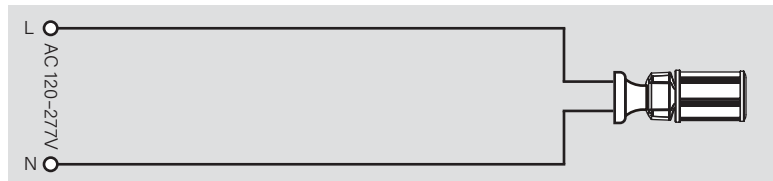
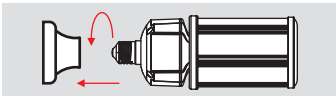

EX39-based lamps will work in *both* **E39** and **EX39** sockets.

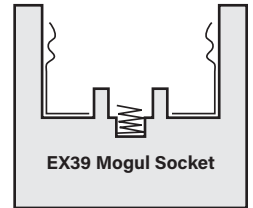
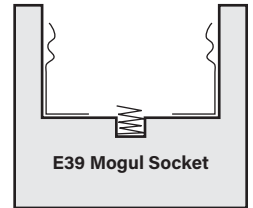

PHYSICAL SPECIFICATIONS

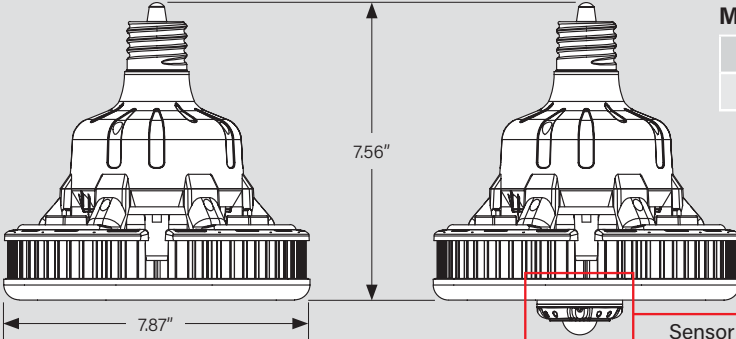

MIN. LAMP COMPARTMENT DIMENSIONS

ORDER CODE	DIMENSIONS
KT-LED80PSHID-V-EX39-8CSB-D	14.17" x 14.17"

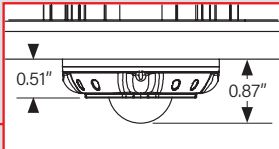

Sensor (sold separately)

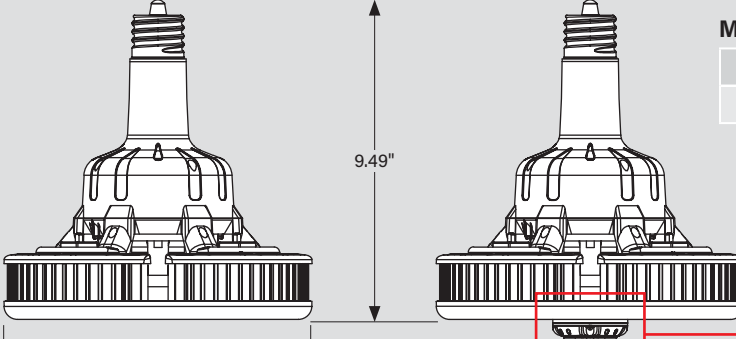

MIN. LAMP COMPARTMENT DIMENSIONS

ORDER CODE	DIMENSIONS
KT-LED115PSHID-V-EX39-8CSB-D	15.75" x 15.75"

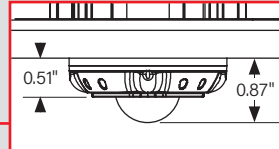

Sensor (sold separately)

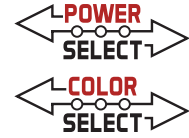

KT-LEDXXXPSHID-V-EX39-8CSB-D

HID REPLACEMENT LED LAMP

ACCESSORIES (SOLD SEPARATELY)

MICROWAVE OCCUPANCY SENSOR

Catalog Number	Description	UPC	Easy Code
KTS-MW3-12V-PKO	Microwave occupancy sensor; Preset for 10 min hold time, no min standby time at 50% dim, daylight disabled	843654135212	TRM-32



PASSIVE INFRARED (PIR) OCCUPANCY SENSOR

Catalog Number	Description	UPC	Easy Code
KTS-PIR3-12V-PKO /G2	PIR occupancy sensor; Preset for 1 min hold time, 1 min standby time at 20% dim, daylight disabled	843654146447	GLF-99



REMOTE CONTROL

Catalog Number	Description	UPC	Easy Code
KTS-MW3-REMOTECONTROL	Remote Control for KTS-MW3-12V-XX and KTS-PIR-12V-XX Sensors. Sets/adjusts all sensor performance parameters	843654132020	XSR-61



SMART LOOP

Catalog Number	Description	UPC	Easy Code
KTSL-FC3-12V-PKO-PIR	Bluetooth mesh wireless Smart Port LED controller for SmartLoop system with integrated daylight and PIR motion sensor.	843654138862	OCW-60
KTSL-FC4-12V-PKO	Bluetooth mesh wireless screw-in low voltage fixture controller for SmartLoop system	843654149066	RUN-10



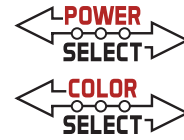

KT-LEDXXXPSHID-V-EX39-8CSB-D

HID REPLACEMENT LED LAMP

ORDERING INFORMATION

ORDER CODE	UPC	EASY CODE	DLC PRODUCT ID
KT-LED80PSHID-V-EX39-8CSB-D	843654134901	UJE-24	PL216EKP32YN
KT-LED115PSHID-V-EX39-8CSB-D	843654134918	OEA-36	PLMNR5F56V9I

CATALOG NUMBER BREAKDOWN

KT-LEDXXXPSHID-V-EX39-8CSB-D

1
2
3
4
5
6
7
8
9
10
11

1 Keystone Technologies

2 LED Lamp

3 Max Wattage

4 Power Select

5 Lamp Type

6 Vertical Orientation

7 Base Type

8 80 CRI

9 Color Select

10 Color Select Designation

11 Direct Drive

3 Max Wattage

80	80W
115	115W

10 Color Select Designation

B	3000/4000/5000K
---	-----------------

7 Base Type

EX39	Mogul Base
------	------------

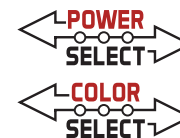

KT-LEDXXXPSHID-V-EX39-8CSB-D

HID REPLACEMENT LED LAMP

DESCRIPTION

Power Select + Color Select HID Replacement LED Lamp | 80 CRI



RoHS Compliant



5 YEAR WARRANTY

LAMP TYPE: HID Replacement LED
BASE TYPE: EX39 (Mogul)
SELECTABLE WATTAGE: 60W - 115W options available
SELECTABLE COLOR TEMPERATURE: 3000/4000/5000K
COLOR RENDERING INDEX (CRI): > 80
WARRANTY: 5 Years

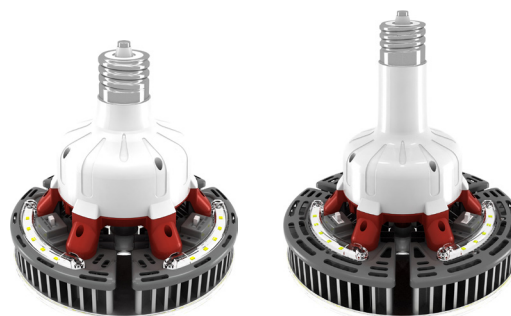

PRODUCT FEATURES

- Keystone Power Select technology (See **Performance Specifications** charts for details)
- Keystone Color Select technology (3000/4000/5000K)
- UL Type B lamp with integrated driver for ballast bypass
- Includes 4kV surge protection
- Instant start up
- Environmentally friendly with no mercury used
- Not suitable for use with dimmers
- Suitable for use in fully enclosed fixtures. See lamp compartment dimensions on page 7
- Suitable for use in damp locations
- 50,000 hour lifetime
- UL 1993 Certified Lamp
- UL 1598C Certified Retrofit Kit
- Operating temperature: -40°C/-40°F - 60°C/140°F

PERFORMANCE SPECIFICATIONS OVERVIEW

Keystone Catalog Number	Selectable Power	Selectable CCT	Lumens	Efficacy	Input Voltage	CRI	Base Type
KT-LED80PSHID-V-EX39-8CSB-D	80/70/60W	3000K 4000K 5000K	11,400/10,150/8,820lm	145 lm/W	120-277V	> 80	EX39
KT-LED115PSHID-V-EX39-8CSB-D	115/95/80W		16,560/13,965/12,160 lm	147 lm/W			EX39

* Color Uniformity: CCT (Correlated Color Temperature) range as per guidelines outlined in ANSI C78.377-2017

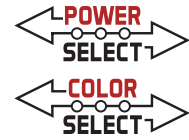

KT-LEDXXXPSHID-V-EX39-8CSB-D

HID REPLACEMENT LED LAMP

PERFORMANCE SPECIFICATIONS DETAILED

Keystone Catalog Number	Selectable Power	Selectable CCT	Lumens	Efficacy	Input Voltage	CRI	Base Type	Smart Port LED
KT-LED80PSHID-V-EX39-8CSB-D	80W	3000K	10,560 lm	132 lm/W	120-277V	> 80	EX39	Compatible
		4000K	11,704 lm	146 lm/W				
		5000K	11,400 lm	143 lm/W				
	70W	3000K	9,590 lm	137 lm/W				
		4000K	10,251 lm	146 lm/W				
		5000K	10,150 lm	145 lm/W				
	60W	3000K	8,340 lm	139 lm/W				
		4000K	8,778 lm	146 lm/W				
		5000K	8,820 lm	147 lm/W				
KT-LED115PSHID-V-EX39-8CSB-D	115W	3000K	15,180 lm	132 lm/W	120-277V	> 80	EX39	Compatible
		4000K	17,136 lm	149 lm/W				
		5000K	16,560 lm	144 lm/W				
	95W	3000K	13,205 lm	139 lm/W				
		4000K	14,352 lm	151 lm/W				
		5000K	13,965 lm	147 lm/W				
	80W	3000K	11,360 lm	142 lm/W				
		4000K	12,166 lm	152 lm/W				
		5000K	12,160 lm	152 lm/W				

* Color Uniformity: CCT (Correlated Color Temperature) range as per guidelines outlined in ANSI C78.377-2017

PRODUCT IMAGES

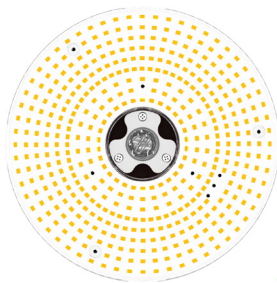
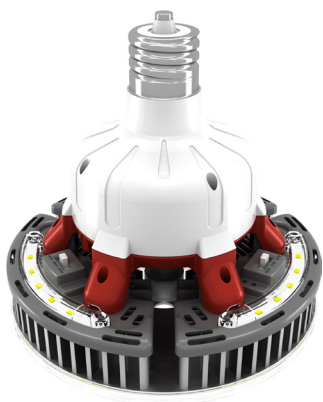

KT-LED80PSHID-V-EX39-8CSB-D

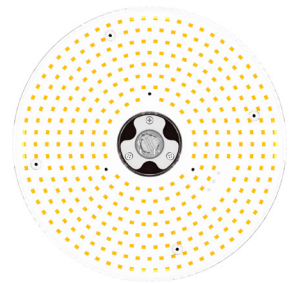

KT-LED115PSHID-V-EX39-8CSB-D

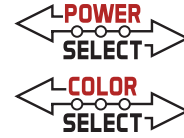

KT-LEDXXXPSHID-V-EX39-8CSB-D

HID REPLACEMENT LED LAMP

POWER SELECT (WATTAGE) AND COLOR SELECT (CCT) ADJUSTMENT

This fixture is equipped with Power Select and Color Select technology.

1. Ensure power is off to the fixture.
2. Adjust dip switches to desired settings.

COLOR SELECT ADJUSTMENT

Set dip switch to adjust CCT between 5000K, 4000K, and 3000K. Fixture comes preset at 5000K.

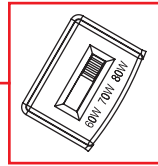
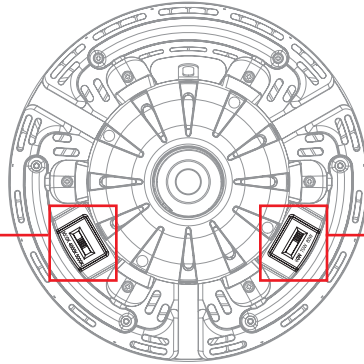
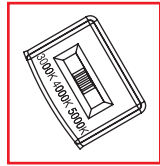

POWER SELECT ADJUSTMENT

Set dip switch to adjust wattage between 60W, 70W, and 80W. Fixture comes preset at 80W.

OPTIONAL SENSOR OR CONTROLLER INSTALLATION INSTRUCTIONS

1. Ensure power is off to the fixture.
2. Use a flat-blade screwdriver to unscrew the 1/2" knock-out; remove knock-out plug.
3. Adjust lamp to maximum wattage (115W) to avoid abnormal sensor behavior (see **Power Select and Color Select Adjustment**).
4. Screw in sensor or controller and hand-tighten it.
5. Re-connect power when ready.

Note: MW3 and PIR3 sensors can be controlled with KTS-MW3-REMOTECONTROL (sold separately).

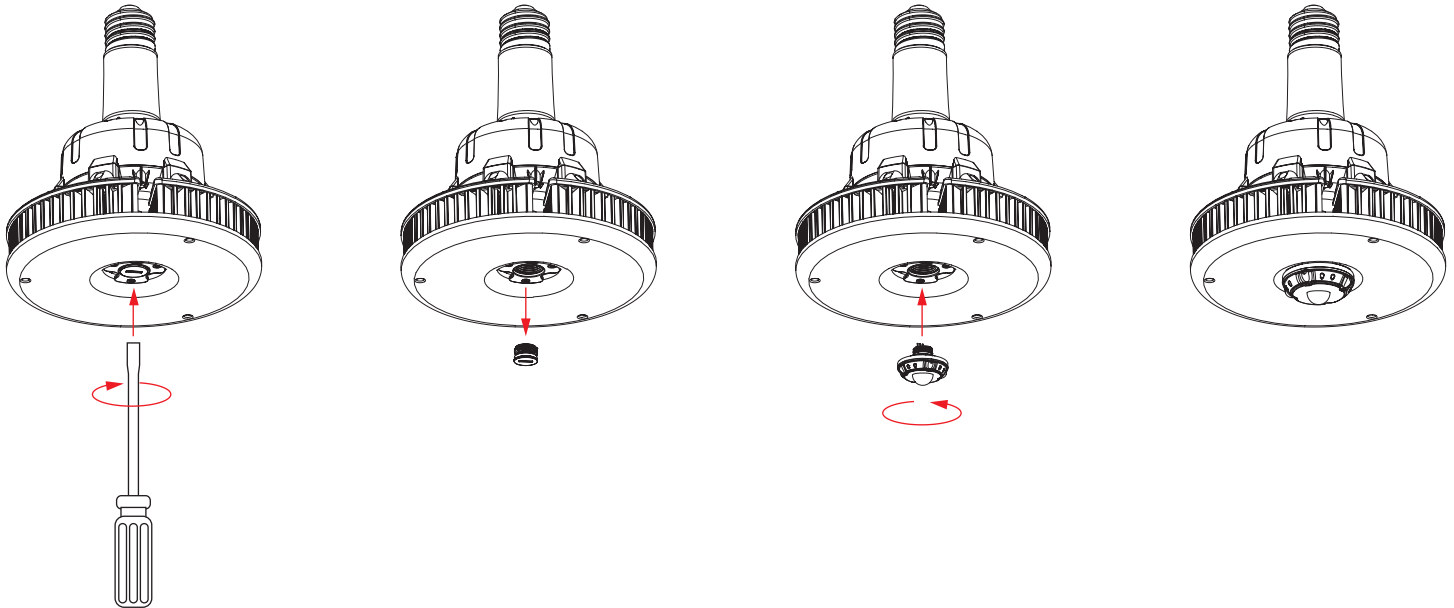

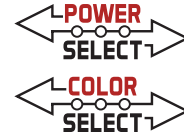

KT-LEDXXXPSHID-V-EX39-8CSB-D

HID REPLACEMENT LED LAMP

WIRING SPECIFICATIONS

STEP 1

Disconnect power. Disconnect and remove existing ballast, capacitor, and/or ignitor (where applicable) from fixture.

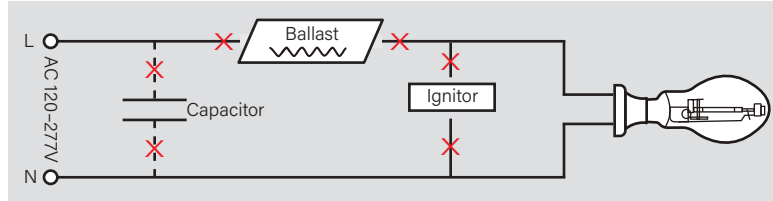

STEP 2

Rewire for line voltage to the lamp socket.

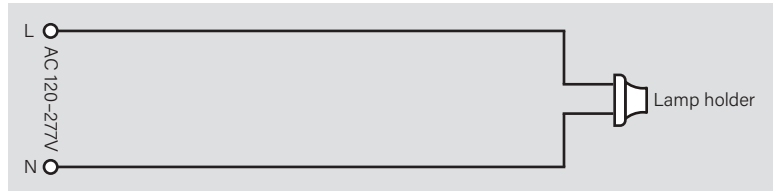

STEP 3

Install new LED replacement lamp. Ensure lamp is operating properly when power is turned on.

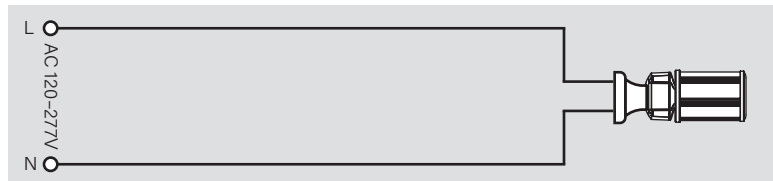
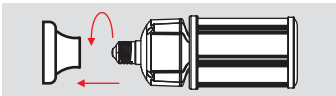

EX39-based lamps will work in *both* **E39** and **EX39** sockets.

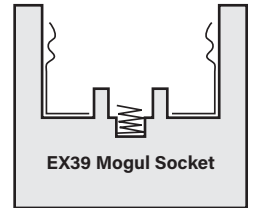
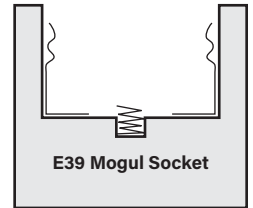

PHYSICAL SPECIFICATIONS

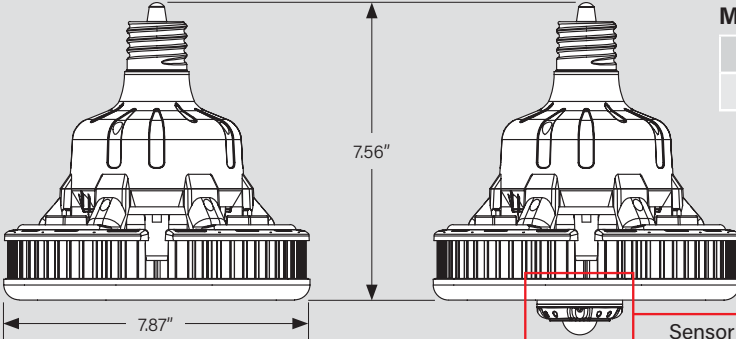

MIN. LAMP COMPARTMENT DIMENSIONS

ORDER CODE	DIMENSIONS
KT-LED80PSHID-V-EX39-8CSB-D	14.17" x 14.17"

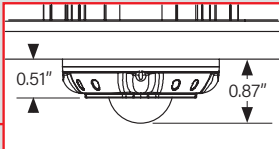

Sensor (sold separately)

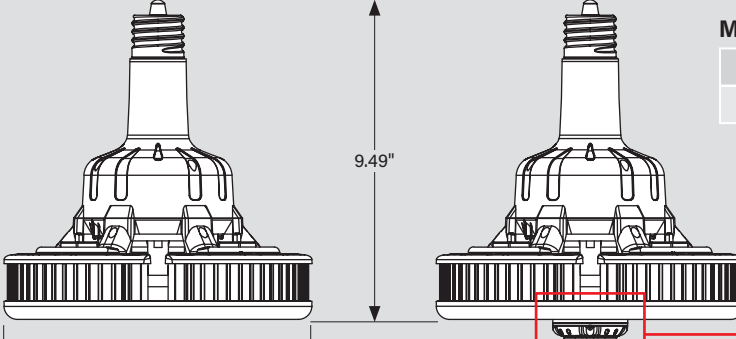

MIN. LAMP COMPARTMENT DIMENSIONS

ORDER CODE	DIMENSIONS
KT-LED115PSHID-V-EX39-8CSB-D	15.75" x 15.75"

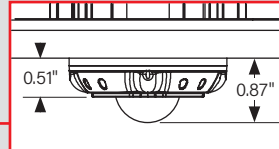

Sensor (sold separately)

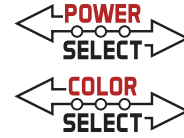

KT-LEDXXXPSHID-V-EX39-8CSB-D

HID REPLACEMENT LED LAMP

ACCESSORIES (SOLD SEPARATELY)

MICROWAVE OCCUPANCY SENSOR

Catalog Number	Description	UPC	Easy Code
KTS-MW3-12V-PKO	Microwave occupancy sensor; Preset for 10 min hold time, no min standby time at 50% dim, daylight disabled	843654135212	TRM-32



PASSIVE INFRARED (PIR) OCCUPANCY SENSOR

Catalog Number	Description	UPC	Easy Code
KTS-PIR3-12V-PKO /G2	PIR occupancy sensor; Preset for 1 min hold time, 1 min standby time at 20% dim, daylight disabled	843654146447	GLF-99



REMOTE CONTROL

Catalog Number	Description	UPC	Easy Code
KTS-MW3-REMOTECONTROL	Remote Control for KTS-MW3-12V-XX and KTS-PIR-12V-XX Sensors. Sets/adjusts all sensor performance parameters	843654132020	XSR-61



SMART LOOP

Catalog Number	Description	UPC	Easy Code
KTSL-FC3-12V-PKO-PIR	Bluetooth mesh wireless Smart Port LED controller for SmartLoop system with integrated daylight and PIR motion sensor.	843654138862	OCW-60
KTSL-FC4-12V-PKO	Bluetooth mesh wireless screw-in low voltage fixture controller for SmartLoop system	843654149066	RUN-10



KTSL-FC3-12V-PKO-PIR



KTSL-FC4-12V-PKO

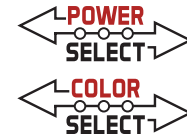

KT-LEDXXXPSHID-V-EX39-8CSB-D

HID REPLACEMENT LED LAMP

ORDERING INFORMATION

ORDER CODE	UPC	EASY CODE	DLC PRODUCT ID
KT-LED80PSHID-V-EX39-8CSB-D	843654134901	UJE-24	PL216EKP32YN
KT-LED115PSHID-V-EX39-8CSB-D	843654134918	OEA-36	PLMNR5F56V9I

CATALOG NUMBER BREAKDOWN

KT-LEDXXXPSHID-V-EX39-8CSB-D

1
2
3
4
5
6
7
8
9
10
11

1 Keystone Technologies

2 LED Lamp

3 Max Wattage

4 Power Select

5 Lamp Type

6 Vertical Orientation

7 Base Type

8 80 CRI

9 Color Select

10 Color Select Designation

11 Direct Drive

3 Max Wattage

80	80W
115	115W

10 Color Select Designation

B	3000/4000/5000K
---	-----------------

7 Base Type

EX39	Mogul Base
------	------------