



KT-LED82P-EV-8XX-D

2-PIN LED CFL REPLACEMENT LAMP

DESCRIPTION

8W 2-Pin LED Lamp | 2700K-5000K | G24d Base |
Type B Line Voltage Compatible



LAMP TYPE: LED CFL Replacement
BULB TYPE: 2-Pin LED
BASE TYPE: G24d
WATTAGE: 8W
COLOR TEMPERATURE: 2700K-5000K
COLOR RENDERING INDEX (CRI): ≥ 83
WARRANTY: 5 Years



PRODUCT FEATURES

- Replaces 26W, 32W, and 42W legacy lamps with G24q, GX24q, G24d, and GX24d bases
- G24d 2-pin bases can be used in G24Q 4-pin applications for ballast bypass
- Approximately 50% more energy efficient vs legacy CFL lamps
- Up to 5x longer life vs traditional lamps
- Frosted diffuser that eliminates pixilation and glare
- Environmentally friendly. No mercury used

- Instant startup
- UL Classified Retrofit Kit
- Suitable for use in damp locations
- Non dimmable
- 50,000 hour lifetime
- Operating temperature: -20°C/-4°F to 45°C/113°F
- Suitable for use in fully enclosed fixtures
- Minimum compartment dimensions: 22cm x 10cm / 7.87" x 3.94"

*G24q-5/6/7 and Gx24q-5/6/7 not compatible

PERFORMANCE SPECIFICATIONS

Catalog Number	Wattage	CCT	Lumens	Efficacy	Input Voltage	CRI	Base Type	Beam Angle	Related Life
KT-LED82P-EV-827-D	5.5W	2700K	900	113 lm/W	120-277V	≥ 83	G24d	> 120°	50,000 hrs
KT-LED82P-EV-830-D		3000K	900	113 lm/W					
KT-LED82P-EV-840-D		3500K	950	119 lm/W					
KT-LED82P-EV-850-D		4000K	950	119 lm/W					

KT-LED82P-EV-8XX-D

2-PIN LED CFL REPLACEMENT LAMP

PHOTOMETRIC SPECIFICATIONS

POLAR CANDELA DISTRIBUTION

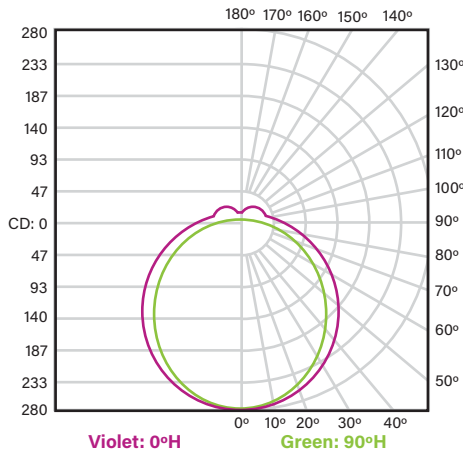

WIRING

BYPASS MAGNETIC BALLAST WITH 1 LAMP

BEFORE

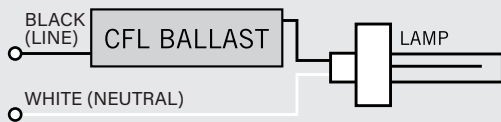

AFTER

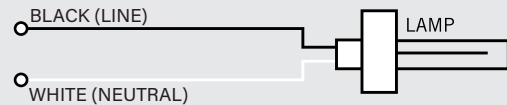

BYPASS ELECTRONIC BALLAST WITH 1 LAMP

BEFORE

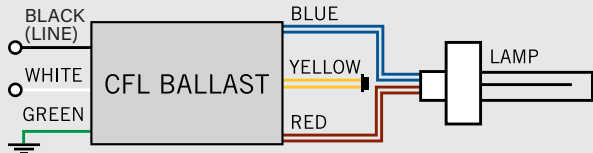

AFTER

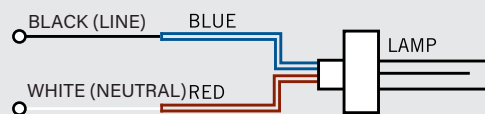

BYPASS MAGNETIC BALLAST WITH 2 LAMPS

BEFORE

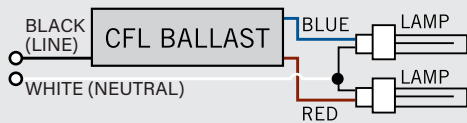

AFTER

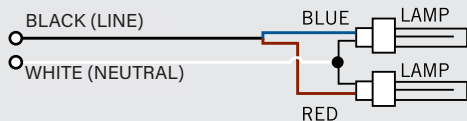

BYPASS ELECTRONIC BALLAST WITH 2 LAMPS

BEFORE

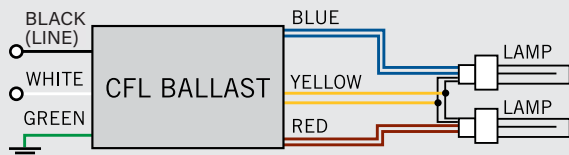

AFTER

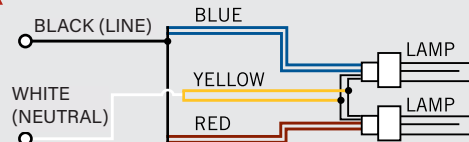



KT-LED82P-EV-8XX-D

2-PIN LED CFL REPLACEMENT LAMP

PHYSICAL SPECIFICATIONS

LAMP DIMENSIONS

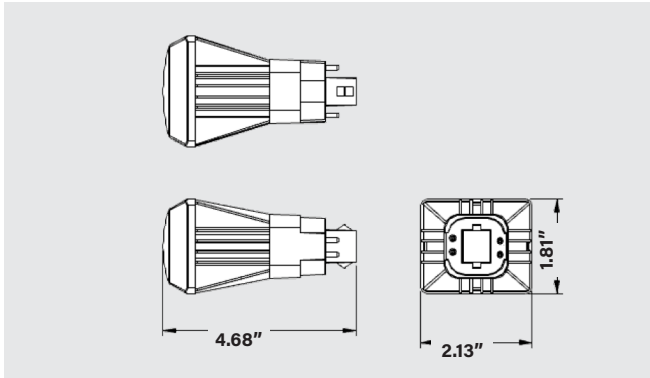

ORDERING INFORMATION

ORDER CODE	UPC	EASY CODE
KT-LED82P-EV-827-D-DP	89094901279	YYS-48
KT-LED82P-EV-830-D-DP	89094901280	BPX-36
KT-LED82P-EV-835-D-DP	89094901281	EOK-95
KT-LED82P-EV-840-D-DP	89094901282	PQH-63
KT-LED82P-EV-850-D-DP	89094901283	CVI-12

CATALOG NUMBER BREAKDOWN

KT-LED82P-EV-8XX-D

1 2 3 4 5 6 7 8

- 1 Keystone Technologies
- 2 LED Lamp
- 3 Wattage
- 4 Lamp Type
- 5 Extended Vertical Orientation
- 6 80 CRI
- 7 CCT
- 8 Direct Drive Series