

1F Condulet® Conduit Bodies - Cast Iron or Aluminum

Gasket and Covers see page 8

1F

Applications:

- Conduit outlet bodies are installed in conduit systems to:
- Act as pull outlets for conductors being installed
 - Provide openings for making splices and taps in conductors
 - Connect conduit sections
 - Provide taps for branch conduit runs
 - Make 90° bends in conduit runs
 - Provide for access to conductors for maintenance and future system changes

Features:

Conduit Outlet Bodies

- Form 7 Condulet outlet bodies approach conduit in size for neat, compact installations
- Form 8 and Mark 9 bodies provide more room for heavier conductors
- Many shapes and sizes are available for rigid threaded conduit – for complete listings see pages 6–12
- Conduit hubs have tapered threads and feature integral bushings for protection of wire insulation
- Form 7 has exclusive snaptight and wedgenut cover attachment to provide clear, unobstructed cover opening
- Built-in rollers on all Form 5 1 1/4" to 4" C and LB bodies to facilitate wire pulling
- Series 5 bodies available in optional configuration with set screws on hubs for EMT conduit (add suffix -MT to catalog number)

Gaskets

Solid gaskets:

- Are used with blank covers
- For Mark 9 and Form 5, can be converted to open type gaskets by tearing out center section along scored lines – 1/2" to 2" sizes
- For Form 7 are used with all covers

Open gaskets:

- For Form 8 – 1/2" to 4" sizes
- For Mark 9 – 2 1/2" to 4" sizes

Blank Covers

Stainless steel cover screws are standard on Form 7, Form 8, Mark 9, Series 5 and Form 5 covers.

• Form 7

Wedge nut design facilitates installation and removal. Nuts are held captive in cover. Covers can be used with or without gaskets. SNAPTIGHT™ Form 7 Covers with integral sealing gaskets are installed without the use of screws, reducing installation time and costs. Covers are reusable.

• Form 8

Two cover screws provided on all sizes to provide tight cover and gasket assembly. *Feraloy* iron alloy covers have dome shapes for added strength and extra wiring room.

• Mark 9

Self-retaining cover screws.

Certifications and Compliances:

Outlet Bodies –

- UL Standard: 514B
- Fed. Spec.: W-C-586D
- CSA Standard 22.2 No. 18
- NEMA 3R Raintight (when installed with cover and gasket)

Standard Materials:

- Form 7, Form 8 outlet bodies – *Feraloy* iron alloy
- Mark 9 outlet bodies – copper-free aluminum
- Form 5 – malleable iron
- Series 5 – die cast aluminum

Standard Finishes:

- Form 7, Form 8 outlet bodies – electrogalvanized with aluminum acrylic paint
- Mark 9 outlet bodies – natural
- Form 5 – electrogalvanized with aluminum acrylic paint
- Series 5 – aluminum acrylic paint

Options:

Description	Suffix
Form 7 body and cover only:	
Copper-free aluminum	SA
<i>Corro-free</i> ™ epoxy powder coat - external body only	S752
<i>Corro-free</i> ™ epoxy powder coat - internal and external	S753
Series 5 in an EMT version with set screws on all hubs	MT
Series 5 pre-packaged with neoprene gasket and cover	CGN



Form 7



Mark 9

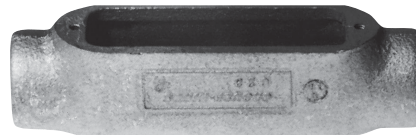

Form 8











Mogul

Condulet® Conduit Bodies - Cast Iron or Aluminum

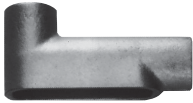
1F

Dimensions Pgs. See pages 10–12 (Dimensions for Form 5 – see Section CP)

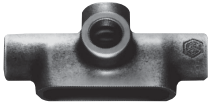
Threaded Rigid Bodies

Shape	Style	Hub Size										
		1/2	3/4	1	1 1/4	1 1/2	2	2 1/2	3	3 1/2	4	
	C											
	Form 7	C17	C27	C37	C47	C57	C67	C77	C87			
	Form 8	C18	C28	C38	C448	C58	C68	C78	C88			
	Mark 9	C19	C29	C39	C49	C59	C69	C789	C889	C989	C1089	
	Form 5	C50M	C75M	C100M	C125M*	C150M*	C200M*	C250M*	C300M*	C350M*	C400M*	
Series 5	C15	C25	C35	C45	C55	C65	C75	C85	C95*	C105*		
	E											
	Form 7	E17	E27	E37								
	L											
	Form 7	L17	L27	L37	L47	L57	L67					
Double faced – may be used as LL or LR – has 2 openings, one of which is furnished with a blank sheet steel cover												
	LB											
	Form 7	LB17	LB27	LB37	LB47	LB57	LB67	LB777	LB87	LB97	LB107	
	Form 8	LB18	LB28	LB38	LB448	LB58	LB68	LB78	LB888	LB98	LB108	
	Mark 9	LB19	LB29	LB39	LB49	LB59	LB69	LB789	LB889	LB989	LB1089	
	Form 5	LB50M	LB75M	LB100M	LB125M*	LB150M*	LB200M*	LB250M*	LB300M*	LB350M*	LB400M*	
Series 5	LB15	LB25	LB35	LB45	LB55	LB65	LB75	LB85	LB95	LB105		
	LL											
	Form 7	LL17	LL27	LL37	LL47	LL57	LL67	LL777	LL87	LL97	LL107	
	Form 8	LL18	LL28	LL38	LL448	LL58	LL68	LL78	LL888			
	Mark 9	LL19	LL29	LL39	LL49	LL59	LL69	LL789	LL889	LL989	LL1089	
	Form 5	LL50M	LL75M	LL100M	LL125M	LL150M	LL200M	LL250M	LL300M	LL350M	LL400M	
Series 5	LL15	LL25	LL35	LL45	LL55	LL65	LL75	LL85	LL95	LL105		
	LR											
	Form 7	LR17	LR27	LR37	LR47	LR57	LR67	LR777	LR87	LR97	LR107	
	Form 8	LR18	LR28	LR38	LR448	LR58	LR68	LR78	LR888			
	Mark 9	LR19	LR29	LR39	LR49	LR59	LR69	LR789	LR889	LR989	LR1089	
	Form 5	LR50M	LR75M	LR100M	LR125M	LR150M	LR200M	LR250M	LR300M	LR350M	LR400M	
Series 5	LR15	LR25	LR35	LR45	LR55	LR65	LR75	LR85	LR95	LR105		
	T											
	Form 7	T17	T27	T37	T47	T57	T67	T77	T87	T97	T107	
	Form 8	T18	T28	T38	T448	T58	T68	T78	T88			
	Mark 9	T19	T29	T39	T49	T59	T69	T789	T889	T989	T1089	
	Form 5	T50M	T75M	T100M	T125M	T150M	T200M	T250M	T300M	T350M	T400M	
Series 5	T15	T25	T35	T45	T55	T65	T75	T85	T95*	T105*		
	TA											
	Form 7	TA17	TA27	TA37	TA47	TA57	TA67					
	TB											
	Form 7	TB17	TB27	TB37	TB47	TB57	TB67					
	Form 8	TB18	TB28	TB38	TB448	TB58	TB68					
	Mark 9	TB19	TB29	TB39	TB49	TB59	TB69					
	Form 5	TB15	TB25	TB35	TB45	TB55	TB65					
Series 5	TB50M	TB75M	TB100M	TB125M	TB150M	TB200M						
	X											
	Form 7	X17	X27	X37	X47	X57	X67					
	Form 8	X18	X28	X38	X448	X58	X68					
	Mark 9	X19	X29	X39								
	Form 5	X15	X25	X35	X45	X55	X65					
Series 5	X50M	X75M	X100M	X125M	X150M	X200M						

* 1/2" - 4" Form 5 LB and C bodies are supplied with built-in rollers to facilitate wire pulling.

Covers and Gaskets

Dimensions Pgs. See pages 10–12 (Dimensions for Form 5 – see Section CP)

Blank Covers



Sheet Steel

Size	Form 7 Wedgenut Cat. #	Form 7 Snaptight™ Covers‡ Cat. #	Form 7 Wedgenut w/Integral Gasket Cat. #	Form 8§ Cat. #	Form 8 w/Integral Gasket Cat. #	Form 5 w/Integral Gasket** Cat. #
1/2	170	170SG	170G	180	180G	K50SG
3/4	270	270SG	270G	280	280G	K75SG
1	370	370SG	370G	380	380G	K100SG
1 1/4	470	470SG	470G	480	480G	K125SG
1 1/2	570	570SG	570G	580	580G	K125SG
2	670	670SG	670G	680	680G	K200SG
2 1/2	870		870G	880		K250SG
3	870		870G	880		K250SG
3 1/2	970		970G	980		K350SG
4	970		970G	980		K350SG

‡Form 7 Snaptight covers with integral sealing gasket are installed without the use of screws.
§Two cover screws on 1/2" to 2" Form 8 covers and four cover screws on 2 1/2" and larger Form 8 covers.
**For cover without integral gasket, remove G from catalog number.



Sheet Aluminum



Feraloy® Iron Alloy



Cast Aluminum

Size	Mark 9 Cat. #	Mark 9 w/Integral Gasket Cat. #	Form 7 Cat. #	Form 7 w/Integral Gasket Cat. #	Series 5 w/Integral Gasket** Cat. #	Form 7 Wedgenut Cat. #	Form 7 Wedgenut w/Integral Gasket Cat. #	Form 8§ Cat. #	Form 5‡ Cat. #	Form 7 Wedgenut Cat. #
1/2	190	190G	170 SA	170G SA	150 G	170F	170FG	180F	K50CM	170F SA
3/4	290	290G	270 SA	270G SA	250 G	270F	270FG	280F	K75CM	270F SA
1	390	390G	370 SA	370G SA	350 G	370F	370FG	380F	K100CM	370F SA
1 1/4	490	490G	470 SA	470G SA	450 G	470F	470FG	480F	K125CM	470F SA
1 1/2	590	590G	570 SA	570G SA	450 G	570F	570FG	580F	K125CM	570F SA
2	690	690G	670 SA	670G SA	650 G	670F	670FG	680F	K200CM	670F SA
2 1/2	889		870 SA		850 G	870F		880F	K250CM	870F SA
3	889		870 SA		850 G	870F		880F	K250CM	870F SA
3 1/2	989		970 SA		950 G	970F		980F	K350CM	970F SA
4	989		970 SA		950 G	970F		980F	K350CM	970F SA

‡Malleable iron covers.
§Two cover screws on 1/2" to 2" Form 8 covers and four cover screws on 2 1/2" and larger Form 8 covers.
**For cover without integral gasket, remove G from catalog number.

Solid Gaskets - Neoprene



Size	Form 7 Cat. #	Form 8* Cat. #	Mark 9‡ Cat. #	Form 5 Cat. #	Series 5 Cat. #
1/2	GASK571	GASK851N	GASK1941	GK50N	GASK015N
3/4	GASK572	GASK852N	GASK1942	GK75N	GASK025N
1	GASK573	GASK853N	GASK1943	GK100N	GASK035N
1 1/4	GASK574	GASK854N	GASK1944	GK125N	GASK045N
1 1/2	GASK575	GASK805N	GASK1945	GK125N	GASK045N
2	GASK576	GASK806N	GASK1946	GK200N	GASK065N
2 1/2	GASK578	GASK808N	GASK808N	GK250N	GASK085N
3	GASK578	GASK808N	GASK808N	GK250N	GASK085N
3 1/2	GASK579	GASK809N	GASK809N	GK350N	GASK095N
4	GASK579	GASK809N	GASK809N	GK350N	GASK095N

*1/2 – 1 1/4 are solid gaskets; 1 1/2 – 4 are open gaskets.
‡1/2 – 2 are solid gaskets; 2 1/2 – 4 are open gaskets.

Condulet® Conduit Bodies - Cast Iron or Aluminum

Dimensions (In Inches)

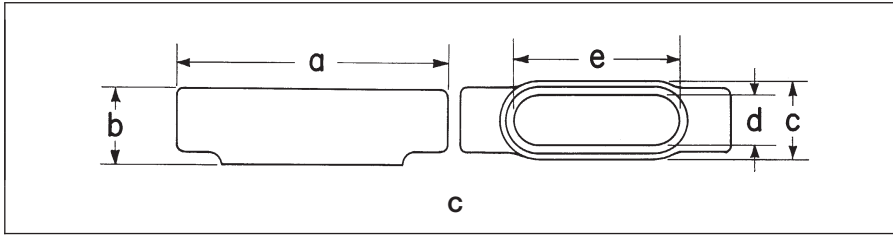

Form 7 C

Size	1/2	3/4	1	1 1/4	1 1/2	2	2 1/2	3
a	5 5/8	6	7	7 7/16	8 3/16	9 3/16	12	11 3/4
b	1 3/8	1 5/8	1 7/8	2 5/16	2 9/16	3 1/8	3 5/8	4 3/8
c	1 3/8	1 9/16	1 3/4	2 3/16	2 7/16	3	4 1/4	4 1/4
d	1 5/16	1 1/8	1 3/8	1 3/4	1 15/16	2 7/16	3 3/16	3 9/16
e	3 3/16	3 13/16	4 1/2	5	5 7/16	6 5/8	8 3/8	8 5/8

Form 8 C

Size	1/2	3/4	1	1 1/4	1 1/2	2	2 1/2	3
a	5 11/16	6 9/32	7 5/16	8 1/2	10 3/8	12 1/4	15 5/8	15 5/8
b	1 7/16	1 11/16	1 15/16	2 3/8	2 25/32	3 3/16	4 7/16	4 13/16
c	1 3/8	1 3/16	1 3/4	2 3/16	2 3/4	3 3/4	5	5
d	1	1 3/16	1 3/8	1 3/4	2 1/8	3	4 1/4	4 1/4
e	3 5/16	3 15/16	4 9/16	5 5/16	6 1/2	8 9/16	10 7/8	10 7/8

Mark 9 C

Size	1/2	3/4	1	1 1/4	1 1/2	2	2 1/2	3	3 1/2	4
a	4 31/32	5 11/32	6 19/32	7 5/8	8 11/32	10 5/8	15 5/8	15 5/8	18 3/4	18 3/4
b	1 13/32	1 5/8	1 7/8	2 1/2	2 13/16	3 7/16	4 7/16	4 13/16	5 11/16	5 15/16
c	1 3/8	1 9/16	1 3/4	2 3/16	2 1/2	3 3/32	5	5	6 1/4	6 1/4
d	1 1/8	1 1/4	1 5/8	1 27/32	2 3/32	2 25/32	4 1/4	4 1/4	5 1/16	5 7/16
e	3 9/32	3 27/32	4 9/16	5 3/16	5 5/8	8 3/32	10 7/8	10 7/8	13 7/16	13 7/16

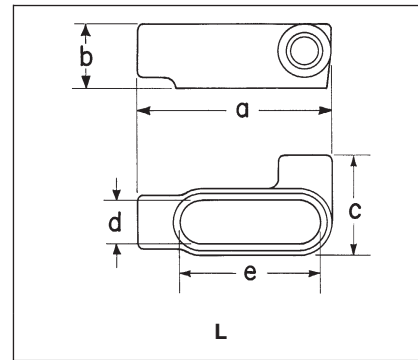
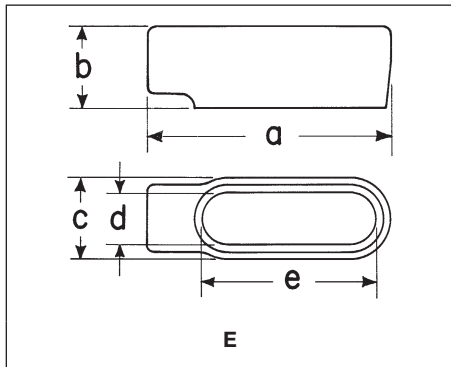

Form 7 E

Size	1/2	3/4	1
a	4 9/16	5 3/16	6
b	1 3/8	1 5/8	1 7/8
c	1 3/8	1 9/16	1 3/4
d	1 5/16	1 1/8	1 3/8
e	3 3/16	3 13/16	4 1/2

Form 7 L

Size	1/2	3/4	1	1 1/4	1 1/2	2
a	4 9/16	5 3/16	6	6 1/2	7 1/8	8 1/8
b	1 3/8	1 5/8	1 7/8	2 5/16	2 9/16	3 1/8
c	2 1/4	2 7/16	2 3/4	3 3/16	3 9/16	4 1/8
d	1 5/16	1 1/8	1 3/8	1 3/4	1 15/16	2 1/16
e	3 3/16	3 13/16	4 1/2	5	5 7/16	6 5/8

Condulet® Conduit Bodies - Cast Iron or Aluminum

1F

Dimensions (In Inches)

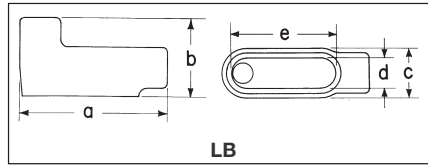

Form 7 LB

Size	1/2	3/4	1	1 1/4	1 1/2	2	2 1/2	3	3 1/2	4
a	4 9/16	5 3/16	6	6 1/2	7 1/8	8 3/8	10 1/2	10 1/2	12 11/16	12 11/16
b	2 1/4	2 1/2	2 7/8	3 9/16	3 11/16	4 1/4	5 1/8	5 7/8	6 9/16	7 1/16
c	1 3/8	1 9/16	1 3/4	2 3/16	2 7/16	3	4 1/4	4 1/4	5 1/4	5 1/4
d	1 5/16	1 1/8	1 3/8	1 3/4	1 15/16	2 7/16	3 9/16	3 9/16	4 1/2	4 1/2
e	3 3/16	3 13/16	4 1/2	5	5 7/16	6 3/8	8 3/8	8 3/8	10 1/4	10 1/4

Form 8 LB

Size	1/2	3/4	1	1 1/4	1 1/2	2	2 1/2	3	3 1/2	4
a	4 15/16	5 9/16	6 15/32	7 17/32	9 1/8	11	13 15/16	13 15/16	16 7/8	16 7/8
b	2 7/32	2 7/16	2 19/16	3 11/32	4 1/32	4 13/16	6 1/8	6 1/2	7 9/16	7 13/16
c	1 3/8	1 9/16	1 3/4	2 3/16	2 3/4	3 3/4	5	5	6 1/4	6 1/4
d	1	1 3/16	1 3/8	1 3/4	2 1/8	3	4 1/4	4 1/4	5 7/16	5 7/16
e	3 5/16	3 15/16	4 9/16	5 5/16	6 1/2	8 9/16	10 7/8	10 7/8	13 7/16	13 7/16

Mark 9 LB

Size	1/2	3/4	1	1 1/4	1 1/2	2	2 1/2	3	3 1/2	4
a	4 19/32	5 1/4	6 3/32	7 1/32	7 3/4	10 1/32	13 15/16	13 15/16	16 7/8	16 7/8
b	2 1/8	2 13/32	2 27/32	3 15/32	3 3/4	4 15/32	6 1/8	6 1/2	7 9/16	7 13/16
c	1 3/8	1 9/16	1 3/4	2 3/16	2 1/2	3 3/16	5	5	6 1/4	6 1/4
d	1 3/16	1 3/8	1 1/2	1 15/16	2 1/4	2 7/8	4 1/4	4 1/4	5 7/16	5 7/16
e	3 5/16	3 15/16	4 9/16	5 5/16	6	8 1/16	10 7/8	10 7/8	13 7/16	13 7/16



Form 7 LL & LR

Size	1/2	3/4	1	1 1/4	1 1/2	2	2 1/2	3	3 1/2	4
a	4 9/16	5 3/16	6	6 1/2	7 1/8	8 3/8	10 1/2	10 1/2	12 11/16	12 11/16
b	1 3/8	1 3/8	1 7/8	2 3/16	2 9/16	3 3/8	3 3/8	4 3/8	4 7/8	5 3/8
c	2 1/4	2 7/16	2 3/4	3 3/16	3 9/16	4 1/8	5 1/4	5 1/4	6 15/16	6 15/16
d	1 5/16	1 1/8	1 3/8	1 3/4	1 15/16	2 7/16	3 9/16	3 9/16	4 1/2	4 1/2
e	3 3/16	3 13/16	4 1/2	5	5 7/16	6 3/8	8 3/8	8 3/8	10 1/4	10 1/4

Form 8 LL & LR

Size	1/2	3/4	1	1 1/4	1 1/2	2	2 1/2	3
a	4 15/16	5 9/16	6 15/32	7 17/32	9 1/8	11	13 15/16	13 15/16
b	1 7/16	1 11/16	1 15/16	2 3/8	2 25/32	3 3/16	4 7/16	4 13/16
c	2 5/32	2 5/16	2 5/8	3 3/32	4	5	6 11/16	6 11/16
d	1	1 3/16	1 3/8	1 3/4	2 1/8	3	4 1/4	4 1/4
e	3 5/16	3 15/16	4 9/16	5 5/16	6 1/2	8 9/16	10 7/8	10 7/8

Mark 9 LL & LR

Size	1/2	3/4	1	1 1/4	1 1/2	2	2 1/2	3	3 1/2	4
a	4 19/32	5 1/4	6 3/32	7 1/32	7 3/4	10 1/32	13 15/16	13 15/16	16 7/8	16 7/8
b	1 3/8	1 3/8	1 7/8	2 1/2	2 3/4	3 7/16	4 7/16	4 3/16	5 11/16	5 15/16
c	2 1/8	2 3/8	2 5/8	3 3/32	3 7/16	4 1/8	6 11/16	6 11/16	8 1/8	8 1/8
d	1 3/16	1 3/8	1 1/2	1 15/16	2 1/4	2 7/8	4 1/4	4 1/4	5 7/16	5 7/16
e	3 5/16	3 15/16	4 9/16	5 5/16	6	8 1/16	10 7/8	10 7/8	13 7/16	13 7/16

Crouse-Hinds

by E.T.N.

1F Condulet® Conduit Bodies - Cast Iron or Aluminum

Dimensions (In Inches)

1F

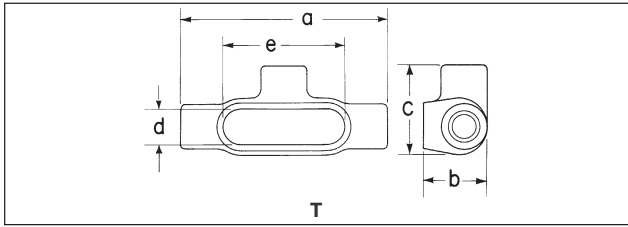

Form 7T

Size	a	b	c	d	e
1/2	5 ⁵ / ₈	1 ³ / ₄	2 ⁷ / ₁₆	1 ⁵ / ₁₆	3 ³ / ₁₆
3/4	6 ¹ / ₄	2	2 ⁵ / ₈	1 ¹ / ₈	3 ¹³ / ₁₆
1	7 ¹ / ₄	2 ¹ / ₄	3	1 ³ / ₈	4 ¹ / ₂
1 ¹ / ₄	7 ⁷ / ₁₆	2 ⁵ / ₁₆	3 ³ / ₁₆	1 ³ / ₄	5
1 ¹ / ₂	8 ³ / ₁₆	2 ⁹ / ₁₆	3 ⁷ / ₁₆	1 ¹⁵ / ₁₆	5 ⁷ / ₁₆
2	9 ⁹ / ₁₆	3 ¹ / ₈	4 ¹ / ₈	2 ⁷ / ₁₆	6 ³ / ₈
2 ¹ / ₂	12	3 ⁵ / ₈	5 ¹ / ₄	3 ³ / ₁₆	8 ³ / ₈
3	12 ¹ / ₁₆	4 ³ / ₈	5 ³ / ₄	3 ³ / ₁₆	8 ³ / ₈
3 ¹ / ₂	14 ⁵ / ₁₆	4 ⁷ / ₈	6 ¹⁵ / ₁₆	4 ¹ / ₂	10 ¹ / ₄
4	14 ³ / ₁₆	5 ³ / ₈	6 ¹⁵ / ₁₆	4 ¹ / ₂	10 ¹ / ₄

Form 8T

1/2	5 ¹¹ / ₁₆	1 ³ / ₄	2 ⁵ / ₃₂	1	3 ⁵ / ₁₆
3/4	6 ⁹ / ₃₂	2	2 ⁹ / ₁₆	1 ³ / ₁₆	3 ¹⁵ / ₁₆
1	7 ⁵ / ₁₆	2 ¹ / ₄	2 ⁵ / ₈	1 ³ / ₈	4 ⁹ / ₁₆
1 ¹ / ₄	8 ¹ / ₂	2 ⁵ / ₈	3 ⁵ / ₃₂	1 ³ / ₄	5 ⁵ / ₁₆
1 ¹ / ₂	10 ⁹ / ₁₆	2 ²⁵ / ₃₂	4	2 ¹ / ₈	6 ¹ / ₂
2	12 ¹ / ₄	3 ⁹ / ₁₆	5	3	8 ⁷ / ₁₆
2 ¹ / ₂	15 ⁵ / ₈	4 ⁷ / ₁₆	6 ¹¹ / ₁₆	4 ¹ / ₄	10 ⁷ / ₈
3	15 ⁵ / ₈	4 ¹³ / ₁₆	6 ¹¹ / ₁₆	4 ¹ / ₄	10 ⁷ / ₈

Mark 9T

1/2	5	1 ³ / ₈	2 ¹ / ₈	1 ¹ / ₁₆	3 ⁵ / ₁₆
3/4	5 ¹¹ / ₁₆	1 ⁵ / ₈	2 ³ / ₈	1 ³ / ₈	3 ¹⁵ / ₁₆
1	6 ¹⁹ / ₃₂	1 ⁷ / ₈	2 ⁵ / ₈	1 ¹ / ₂	4 ⁹ / ₁₆
1 ¹ / ₄	7 ¹ / ₂	2 ¹ / ₂	3 ³ / ₃₂	1 ¹⁵ / ₁₆	5 ⁵ / ₁₆
1 ¹ / ₂	8 ¹ / ₄	2 ³ / ₄	3 ⁷ / ₁₆	2 ¹ / ₄	6
2	10 ¹ / ₂	3 ⁷ / ₁₆	4 ¹ / ₈	2 ⁷ / ₈	8 ¹ / ₁₆
2 ¹ / ₂	15 ⁵ / ₈	4 ⁷ / ₁₆	6 ¹¹ / ₁₆	4 ¹ / ₄	10 ⁷ / ₈
3	15 ⁵ / ₈	4 ¹³ / ₁₆	6 ¹¹ / ₁₆	4 ¹ / ₄	10 ⁷ / ₈
3 ¹ / ₂	18 ³ / ₄	5 ¹¹ / ₁₆	8 ¹ / ₈	5 ⁷ / ₁₆	13 ⁷ / ₁₆
4	18 ³ / ₄	5 ¹⁵ / ₁₆	8 ¹ / ₈	5 ⁷ / ₁₆	13 ⁷ / ₁₆

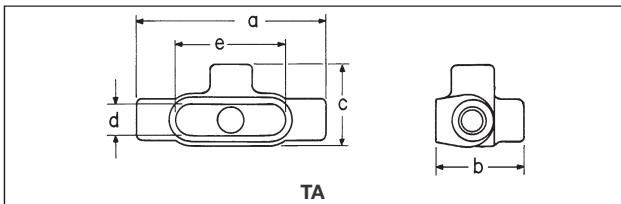

Form 7TA

Size	a	b	c	d	e
1/2	5 ⁵ / ₈	2 ⁵ / ₈	2 ⁷ / ₁₆	1 ⁵ / ₁₆	3 ³ / ₁₆
3/4	6 ¹ / ₄	2 ⁷ / ₈	2 ⁵ / ₈	1 ¹ / ₈	3 ¹³ / ₁₆
1	7 ¹ / ₄	3 ¹ / ₄	3	1 ³ / ₈	4 ¹ / ₂
1 ¹ / ₄	7 ⁷ / ₁₆	3 ⁵ / ₁₆	3 ³ / ₁₆	1 ³ / ₄	5
1 ¹ / ₂	8 ³ / ₁₆	3 ¹¹ / ₁₆	3 ⁷ / ₁₆	1 ¹⁵ / ₁₆	5 ⁷ / ₁₆
2	9 ⁹ / ₁₆	4 ¹ / ₄	4 ¹ / ₈	2 ⁷ / ₁₆	6 ³ / ₈

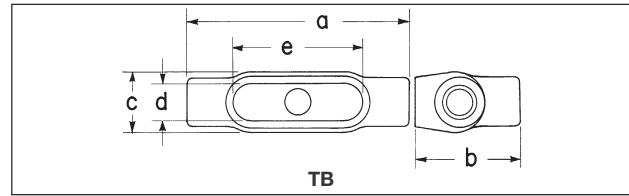

Form 7TB

Size	a	b	c	d	e
1/2	5 ⁵ / ₈	2 ⁵ / ₈	1 ⁹ / ₁₆	1 ⁵ / ₁₆	3 ³ / ₁₆
3/4	6 ¹ / ₄	2 ⁷ / ₈	1 ³ / ₄	1 ¹ / ₈	3 ¹³ / ₁₆
1	7 ¹ / ₄	3 ¹ / ₄	2	1 ³ / ₈	4 ¹ / ₂
1 ¹ / ₄	7 ⁷ / ₁₆	3 ⁵ / ₁₆	2 ³ / ₁₆	1 ³ / ₄	5
1 ¹ / ₂	8 ³ / ₁₆	5	2 ⁷ / ₁₆	1 ¹⁵ / ₁₆	5 ⁷ / ₁₆
2	9 ⁹ / ₁₆	6 ¹ / ₈	3	2 ⁷ / ₁₆	6 ³ / ₈

Form 8TB

1/2	5 ¹¹ / ₁₆	2 ¹⁷ / ₃₂	1 ³ / ₈	1	3 ⁵ / ₁₆
3/4	6 ⁹ / ₃₂	2 ³ / ₄	1 ⁹ / ₁₆	1 ³ / ₁₆	3 ¹⁵ / ₁₆
1	7 ⁵ / ₁₆	3 ¹ / ₈	1 ³ / ₄	1 ³ / ₈	4 ⁹ / ₁₆
1 ¹ / ₄	8 ¹ / ₂	3 ¹¹ / ₃₂	2 ³ / ₁₆	1 ³ / ₄	5 ⁵ / ₁₆
1 ¹ / ₂	10 ⁹ / ₁₆	4 ¹ / ₃₂	2 ³ / ₄	2 ¹ / ₈	6 ¹ / ₂
2	12 ¹ / ₄	4 ¹³ / ₁₆	3 ³ / ₄	3	8 ⁷ / ₁₆

Mark 9TB

1/2	5	2 ¹ / ₈	1 ³ / ₈	1 ³ / ₁₆	3 ⁵ / ₁₆
3/4	5 ¹¹ / ₁₆	2 ¹³ / ₃₂	1 ⁹ / ₁₆	1 ³ / ₈	3 ¹⁵ / ₁₆
1	6 ¹⁹ / ₃₂	2 ²⁷ / ₃₂	1 ³ / ₄	1 ¹ / ₂	4 ⁹ / ₁₆
1 ¹ / ₄	7 ¹ / ₂	3 ¹⁵ / ₃₂	2 ³ / ₁₆	1 ¹⁵ / ₁₆	5 ⁵ / ₁₆
1 ¹ / ₂	8 ¹¹ / ₃₂	3 ⁷ / ₈	2 ¹ / ₂	2 ⁵ / ₃₂	5 ⁷ / ₈
2	10 ⁵ / ₈	4 ¹⁹ / ₃₂	3 ⁷ / ₃₂	2 ¹⁵ / ₁₆	8 ³ / ₃₂

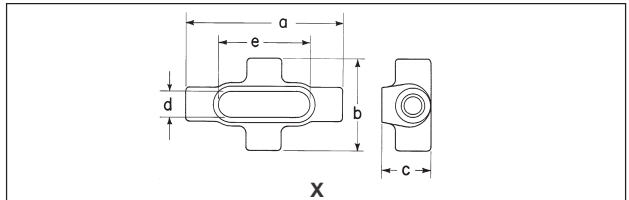

Form 7X

Size	a	b	c	d	e
1/2	5 ⁵ / ₈	3 ³ / ₁₆	1 ³ / ₄	1 ⁵ / ₁₆	3 ³ / ₁₆
3/4	6 ¹ / ₄	3 ¹ / ₂	2	1 ¹ / ₈	3 ¹³ / ₁₆
1	7 ¹ / ₄	4	2 ¹ / ₄	1 ³ / ₈	4 ¹ / ₂
1 ¹ / ₄	7 ⁷ / ₁₆	4 ¹ / ₈	2 ³ / ₁₆	1 ³ / ₄	5
1 ¹ / ₂	8 ³ / ₁₆	4 ⁵ / ₈	2 ³ / ₁₆	1 ¹⁵ / ₁₆	5 ⁷ / ₁₆
2	9 ⁹ / ₁₆	5 ³ / ₁₆	3 ¹ / ₈	2 ⁷ / ₁₆	6 ³ / ₈

Form 8X

1/2	5 ¹¹ / ₁₆	2 ²⁹ / ₃₂	1 ³ / ₄	1	3 ⁵ / ₁₆
3/4	6 ⁹ / ₃₂	3 ¹ / ₁₆	2	1 ³ / ₁₆	3 ¹⁵ / ₁₆
1	7 ⁵ / ₁₆	3 ¹ / ₂	2 ¹ / ₄	1 ³ / ₈	4 ⁹ / ₁₆
1 ¹ / ₄	8 ¹ / ₂	4 ¹ / ₈	2 ⁵ / ₈	1 ³ / ₄	5 ⁵ / ₁₆
1 ¹ / ₂	10 ⁹ / ₁₆	5 ¹ / ₄	2 ¹⁵ / ₃₂	2 ¹ / ₈	6 ¹ / ₂
2	12 ¹ / ₄	6 ¹ / ₄	3 ⁹ / ₁₆	3	8 ⁷ / ₁₆

Mark 9X

1/2	5 ¹¹ / ₁₆	2 ²⁹ / ₃₂	1 ³ / ₄	1	3 ⁵ / ₁₆
3/4	6 ⁹ / ₃₂	3 ¹ / ₁₆	2	1 ³ / ₁₆	3 ¹⁵ / ₁₆
1	7 ⁵ / ₁₆	3 ¹ / ₂	2 ¹ / ₄	1 ³ / ₈	4 ⁹ / ₁₆

Crouse-Hinds
by **E.T.N.**

1F Condulet® Conduit Bodies - Cast Iron or Aluminum

Gasket and Covers see page 8

1F

Applications:

- Conduit outlet bodies are installed in conduit systems to:
- Act as pull outlets for conductors being installed
 - Provide openings for making splices and taps in conductors
 - Connect conduit sections
 - Provide taps for branch conduit runs
 - Make 90° bends in conduit runs
 - Provide for access to conductors for maintenance and future system changes

Features:

Conduit Outlet Bodies

- Form 7 Condulet outlet bodies approach conduit in size for neat, compact installations
- Form 8 and Mark 9 bodies provide more room for heavier conductors
- Many shapes and sizes are available for rigid threaded conduit – for complete listings see pages 6–12
- Conduit hubs have tapered threads and feature integral bushings for protection of wire insulation
- Form 7 has exclusive snaptight and wedgenut cover attachment to provide clear, unobstructed cover opening
- Built-in rollers on all Form 5 1 1/4" to 4" C and LB bodies to facilitate wire pulling
- Series 5 bodies available in optional configuration with set screws on hubs for EMT conduit (add suffix -MT to catalog number)

Gaskets

Solid gaskets:

- Are used with blank covers
- For Mark 9 and Form 5, can be converted to open type gaskets by tearing out center section along scored lines – 1/2" to 2" sizes
- For Form 7 are used with all covers

Open gaskets:

- For Form 8 – 1/2" to 4" sizes
- For Mark 9 – 2 1/2" to 4" sizes

Blank Covers

Stainless steel cover screws are standard on Form 7, Form 8, Mark 9, Series 5 and Form 5 covers.

• Form 7

Wedge nut design facilitates installation and removal. Nuts are held captive in cover. Covers can be used with or without gaskets. SNAPTIGHT™ Form 7 Covers with integral sealing gaskets are installed without the use of screws, reducing installation time and costs. Covers are reusable.

• Form 8

Two cover screws provided on all sizes to provide tight cover and gasket assembly. *Feraloy* iron alloy covers have dome shapes for added strength and extra wiring room.

• Mark 9

Self-retaining cover screws.

Certifications and Compliances:

Outlet Bodies –

- UL Standard: 514B
- Fed. Spec.: W-C-586D
- CSA Standard 22.2 No. 18
- NEMA 3R Raintight (when installed with cover and gasket)

Standard Materials:

- Form 7, Form 8 outlet bodies – *Feraloy* iron alloy
- Mark 9 outlet bodies – copper-free aluminum
- Form 5 – malleable iron
- Series 5 – die cast aluminum

Standard Finishes:

- Form 7, Form 8 outlet bodies – electrogalvanized with aluminum acrylic paint
- Mark 9 outlet bodies – natural
- Form 5 – electrogalvanized with aluminum acrylic paint
- Series 5 – aluminum acrylic paint

Options:

Description	Suffix
Form 7 body and cover only:	
Copper-free aluminum	SA
<i>Corro-free</i> ™ epoxy powder coat - external body only	S752
<i>Corro-free</i> ™ epoxy powder coat - internal and external	S753
Series 5 in an EMT version with set screws on all hubs	MT
Series 5 pre-packaged with neoprene gasket and cover	CGN



Form 7



Mark 9

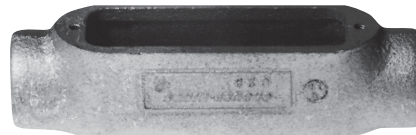

Form 8











Mogul

Condulet® Conduit Bodies - Cast Iron or Aluminum

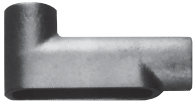
1F

Dimensions Pgs. See pages 10–12 (Dimensions for Form 5 – see Section CP)

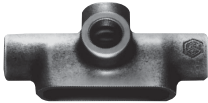
Threaded Rigid Bodies

Shape	Style	Hub Size										
		1/2	3/4	1	1 1/4	1 1/2	2	2 1/2	3	3 1/2	4	
	C											
	Form 7	C17	C27	C37	C47	C57	C67	C77	C87			
	Form 8	C18	C28	C38	C448	C58	C68	C78	C88			
	Mark 9	C19	C29	C39	C49	C59	C69	C789	C889	C989	C1089	
	Form 5	C50M	C75M	C100M	C125M*	C150M*	C200M*	C250M*	C300M*	C350M*	C400M*	
Series 5	C15	C25	C35	C45	C55	C65	C75	C85	C95*	C105*		
	E											
	Form 7	E17	E27	E37								
	L											
	Form 7	L17	L27	L37	L47	L57	L67					
Double faced – may be used as LL or LR – has 2 openings, one of which is furnished with a blank sheet steel cover												
	LB											
	Form 7	LB17	LB27	LB37	LB47	LB57	LB67	LB777	LB87	LB97	LB107	
	Form 8	LB18	LB28	LB38	LB448	LB58	LB68	LB78	LB888	LB98	LB108	
	Mark 9	LB19	LB29	LB39	LB49	LB59	LB69	LB789	LB889	LB989	LB1089	
	Form 5	LB50M	LB75M	LB100M	LB125M*	LB150M*	LB200M*	LB250M*	LB300M*	LB350M*	LB400M*	
Series 5	LB15	LB25	LB35	LB45	LB55	LB65	LB75	LB85	LB95	LB105		
	LL											
	Form 7	LL17	LL27	LL37	LL47	LL57	LL67	LL777	LL87	LL97	LL107	
	Form 8	LL18	LL28	LL38	LL448	LL58	LL68	LL78	LL888			
	Mark 9	LL19	LL29	LL39	LL49	LL59	LL69	LL789	LL889	LL989	LL1089	
	Form 5	LL50M	LL75M	LL100M	LL125M	LL150M	LL200M	LL250M	LL300M	LL350M	LL400M	
Series 5	LL15	LL25	LL35	LL45	LL55	LL65	LL75	LL85	LL95	LL105		
	LR											
	Form 7	LR17	LR27	LR37	LR47	LR57	LR67	LR777	LR87	LR97	LR107	
	Form 8	LR18	LR28	LR38	LR448	LR58	LR68	LR78	LR888			
	Mark 9	LR19	LR29	LR39	LR49	LR59	LR69	LR789	LR889	LR989	LR1089	
	Form 5	LR50M	LR75M	LR100M	LR125M	LR150M	LR200M	LR250M	LR300M	LR350M	LR400M	
Series 5	LR15	LR25	LR35	LR45	LR55	LR65	LR75	LR85	LR95	LR105		
	T											
	Form 7	T17	T27	T37	T47	T57	T67	T77	T87	T97	T107	
	Form 8	T18	T28	T38	T448	T58	T68	T78	T88			
	Mark 9	T19	T29	T39	T49	T59	T69	T789	T889	T989	T1089	
	Form 5	T50M	T75M	T100M	T125M	T150M	T200M	T250M	T300M	T350M	T400M	
Series 5	T15	T25	T35	T45	T55	T65	T75	T85	T95*	T105*		
	TA											
	Form 7	TA17	TA27	TA37	TA47	TA57	TA67					
	TB											
	Form 7	TB17	TB27	TB37	TB47	TB57	TB67					
	Form 8	TB18	TB28	TB38	TB448	TB58	TB68					
	Mark 9	TB19	TB29	TB39	TB49	TB59	TB69					
	Form 5	TB15	TB25	TB35	TB45	TB55	TB65					
Series 5	TB50M	TB75M	TB100M	TB125M	TB150M	TB200M						
	X											
	Form 7	X17	X27	X37	X47	X57	X67					
	Form 8	X18	X28	X38	X448	X58	X68					
	Mark 9	X19	X29	X39								
	Form 5	X15	X25	X35	X45	X55	X65					
Series 5	X50M	X75M	X100M	X125M	X150M	X200M						

* 1/2" - 4" Form 5 LB and C bodies are supplied with built-in rollers to facilitate wire pulling.

Covers and Gaskets

Dimensions Pgs. See pages 10–12 (Dimensions for Form 5 – see Section CP)

Blank Covers



Sheet Steel

Size	Form 7 Wedgenut Cat. #	Form 7 Snaptight™ Covers‡ Cat. #	Form 7 Wedgenut w/Integral Gasket Cat. #	Form 8§ Cat. #	Form 8 w/Integral Gasket Cat. #	Form 5 w/Integral Gasket** Cat. #
1/2	170	170SG	170G	180	180G	K50SG
3/4	270	270SG	270G	280	280G	K75SG
1	370	370SG	370G	380	380G	K100SG
1 1/4	470	470SG	470G	480	480G	K125SG
1 1/2	570	570SG	570G	580	580G	K125SG
2	670	670SG	670G	680	680G	K200SG
2 1/2	870		870G	880		K250SG
3	870		870G	880		K250SG
3 1/2	970		970G	980		K350SG
4	970		970G	980		K350SG

‡Form 7 Snaptight covers with integral sealing gasket are installed without the use of screws.
§Two cover screws on 1/2" to 2" Form 8 covers and four cover screws on 2 1/2" and larger Form 8 covers.
**For cover without integral gasket, remove G from catalog number.



Sheet Aluminum



Feraloy® Iron Alloy



Cast Aluminum

Size	Mark 9 Cat. #	Mark 9 w/Integral Gasket Cat. #	Form 7 Cat. #	Form 7 w/Integral Gasket Cat. #	Series 5 w/Integral Gasket** Cat. #	Form 7 Wedgenut Cat. #	Form 7 Wedgenut w/Integral Gasket Cat. #	Form 8§ Cat. #	Form 5‡ Cat. #	Form 7 Wedgenut Cat. #
1/2	190	190G	170 SA	170G SA	150 G	170F	170FG	180F	K50CM	170F SA
3/4	290	290G	270 SA	270G SA	250 G	270F	270FG	280F	K75CM	270F SA
1	390	390G	370 SA	370G SA	350 G	370F	370FG	380F	K100CM	370F SA
1 1/4	490	490G	470 SA	470G SA	450 G	470F	470FG	480F	K125CM	470F SA
1 1/2	590	590G	570 SA	570G SA	450 G	570F	570FG	580F	K125CM	570F SA
2	690	690G	670 SA	670G SA	650 G	670F	670FG	680F	K200CM	670F SA
2 1/2	889		870 SA		850 G	870F		880F	K250CM	870F SA
3	889		870 SA		850 G	870F		880F	K250CM	870F SA
3 1/2	989		970 SA		950 G	970F		980F	K350CM	970F SA
4	989		970 SA		950 G	970F		980F	K350CM	970F SA

‡Malleable iron covers.
§Two cover screws on 1/2" to 2" Form 8 covers and four cover screws on 2 1/2" and larger Form 8 covers.
**For cover without integral gasket, remove G from catalog number.

Solid Gaskets - Neoprene



Size	Form 7 Cat. #	Form 8* Cat. #	Mark 9† Cat. #	Form 5 Cat. #	Series 5 Cat. #
1/2	GASK571	GASK851N	GASK1941	GK50N	GASK015N
3/4	GASK572	GASK852N	GASK1942	GK75N	GASK025N
1	GASK573	GASK853N	GASK1943	GK100N	GASK035N
1 1/4	GASK574	GASK854N	GASK1944	GK125N	GASK045N
1 1/2	GASK575	GASK805N	GASK1945	GK125N	GASK045N
2	GASK576	GASK806N	GASK1946	GK200N	GASK065N
2 1/2	GASK578	GASK808N	GASK808N	GK250N	GASK085N
3	GASK578	GASK808N	GASK808N	GK250N	GASK085N
3 1/2	GASK579	GASK809N	GASK809N	GK350N	GASK095N
4	GASK579	GASK809N	GASK809N	GK350N	GASK095N

*1/2 – 1 1/4 are solid gaskets; 1 1/2 – 4 are open gaskets.
†1/2 – 2 are solid gaskets; 2 1/2 – 4 are open gaskets.

Condulet® Conduit Bodies - Cast Iron or Aluminum

Dimensions (In Inches)

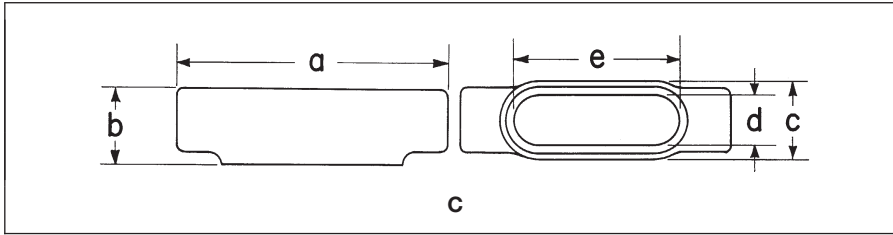

Form 7 C

Size	1/2	3/4	1	1 1/4	1 1/2	2	2 1/2	3
a	5 5/8	6	7	7 7/16	8 3/16	9 3/16	12	11 3/4
b	1 3/8	1 5/8	1 7/8	2 5/16	2 9/16	3 1/8	3 5/8	4 3/8
c	1 3/8	1 9/16	1 3/4	2 3/16	2 7/16	3	4 1/4	4 1/4
d	1 5/16	1 1/8	1 3/8	1 3/4	1 15/16	2 7/16	3 3/16	3 9/16
e	3 3/16	3 13/16	4 1/2	5	5 7/16	6 5/8	8 3/8	8 5/8

Form 8 C

Size	1/2	3/4	1	1 1/4	1 1/2	2	2 1/2	3
a	5 11/16	6 9/32	7 5/16	8 1/2	10 3/8	12 1/4	15 5/8	15 5/8
b	1 7/16	1 11/16	1 15/16	2 3/8	2 25/32	3 3/16	4 7/16	4 13/16
c	1 3/8	1 3/16	1 3/4	2 3/16	2 3/4	3 3/4	5	5
d	1	1 3/16	1 3/8	1 3/4	2 1/8	3	4 1/4	4 1/4
e	3 5/16	3 15/16	4 9/16	5 5/16	6 1/2	8 9/16	10 7/8	10 7/8

Mark 9 C

Size	1/2	3/4	1	1 1/4	1 1/2	2	2 1/2	3	3 1/2	4
a	4 31/32	5 11/32	6 19/32	7 5/8	8 11/32	10 5/8	15 5/8	15 5/8	18 3/4	18 3/4
b	1 13/32	1 5/8	1 7/8	2 1/2	2 13/16	3 7/16	4 7/16	4 13/16	5 11/16	5 15/16
c	1 3/8	1 9/16	1 3/4	2 3/16	2 1/2	3 3/32	5	5	6 1/4	6 1/4
d	1 1/8	1 1/4	1 5/8	1 27/32	2 3/32	2 25/32	4 1/4	4 1/4	5 1/16	5 7/16
e	3 9/32	3 27/32	4 9/16	5 3/16	5 5/8	8 3/32	10 7/8	10 7/8	13 7/16	13 7/16

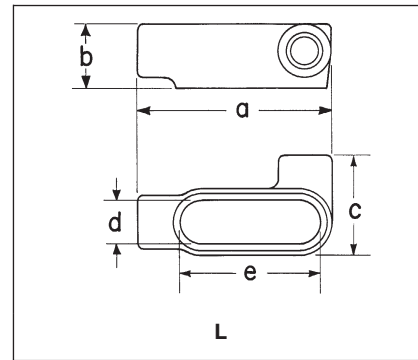
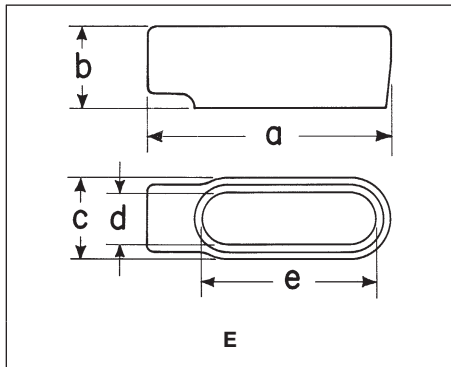

Form 7 E

Size	1/2	3/4	1
a	4 9/16	5 3/16	6
b	1 3/8	1 5/8	1 7/8
c	1 3/8	1 9/16	1 3/4
d	1 5/16	1 1/8	1 3/8
e	3 3/16	3 13/16	4 1/2

Form 7 L

Size	1/2	3/4	1	1 1/4	1 1/2	2
a	4 9/16	5 3/16	6	6 1/2	7 1/8	8 1/8
b	1 3/8	1 5/8	1 7/8	2 5/16	2 9/16	3 1/8
c	2 1/4	2 7/16	2 3/4	3 3/16	3 9/16	4 1/8
d	1 5/16	1 1/8	1 3/8	1 3/4	1 15/16	2 1/16
e	3 3/16	3 13/16	4 1/2	5	5 7/16	6 5/8

Condulet® Conduit Bodies - Cast Iron or Aluminum

1F

Dimensions (In Inches)

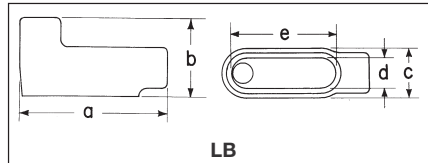

Form 7 LB

Size	1/2	3/4	1	1 1/4	1 1/2	2	2 1/2	3	3 1/2	4
a	4 9/16	5 3/16	6	6 1/2	7 1/8	8 3/8	10 1/2	10 1/2	12 11/16	12 11/16
b	2 1/4	2 1/2	2 7/8	3 9/16	3 11/16	4 1/4	5 1/8	5 7/8	6 9/16	7 1/16
c	1 3/8	1 9/16	1 3/4	2 3/16	2 7/16	3	4 1/4	4 1/4	5 1/4	5 1/4
d	1 5/16	1 1/8	1 3/8	1 3/4	1 15/16	2 7/16	3 9/16	3 9/16	4 1/2	4 1/2
e	3 3/16	3 13/16	4 1/2	5	5 7/16	6 3/8	8 3/8	8 3/8	10 1/4	10 1/4

Form 8 LB

Size	1/2	3/4	1	1 1/4	1 1/2	2	2 1/2	3	3 1/2	4
a	4 15/16	5 9/16	6 15/32	7 17/32	9 1/8	11	13 15/16	13 15/16	16 7/8	16 7/8
b	2 7/32	2 7/16	2 19/16	3 11/32	4 1/32	4 13/16	6 1/8	6 1/2	7 9/16	7 13/16
c	1 3/8	1 9/16	1 3/4	2 3/16	2 3/4	3 3/4	5	5	6 1/4	6 1/4
d	1	1 3/16	1 3/8	1 3/4	2 1/8	3	4 1/4	4 1/4	5 7/16	5 7/16
e	3 5/16	3 15/16	4 9/16	5 5/16	6 1/2	8 9/16	10 7/8	10 7/8	13 7/16	13 7/16

Mark 9 LB

Size	1/2	3/4	1	1 1/4	1 1/2	2	2 1/2	3	3 1/2	4
a	4 19/32	5 1/4	6 3/32	7 1/32	7 3/4	10 1/32	13 15/16	13 15/16	16 7/8	16 7/8
b	2 1/8	2 13/32	2 27/32	3 15/32	3 3/4	4 15/32	6 1/8	6 1/2	7 9/16	7 13/16
c	1 3/8	1 9/16	1 3/4	2 3/16	2 1/2	3 3/16	5	5	6 1/4	6 1/4
d	1 3/16	1 3/8	1 1/2	1 15/16	2 1/4	2 7/8	4 1/4	4 1/4	5 7/16	5 7/16
e	3 5/16	3 15/16	4 9/16	5 5/16	6	8 1/16	10 7/8	10 7/8	13 7/16	13 7/16



Form 7 LL & LR

Size	1/2	3/4	1	1 1/4	1 1/2	2	2 1/2	3	3 1/2	4
a	4 9/16	5 3/16	6	6 1/2	7 1/8	8 3/8	10 1/2	10 1/2	12 11/16	12 11/16
b	1 3/8	1 3/8	1 7/8	2 3/16	2 9/16	3 3/8	3 3/8	4 3/8	4 7/8	5 3/8
c	2 1/4	2 7/16	2 3/4	3 3/16	3 9/16	4 1/8	5 1/4	5 1/4	6 15/16	6 15/16
d	1 5/16	1 1/8	1 3/8	1 3/4	1 15/16	2 7/16	3 9/16	3 9/16	4 1/2	4 1/2
e	3 3/16	3 13/16	4 1/2	5	5 7/16	6 3/8	8 3/8	8 3/8	10 1/4	10 1/4

Form 8 LL & LR

Size	1/2	3/4	1	1 1/4	1 1/2	2	2 1/2	3
a	4 15/16	5 9/16	6 15/32	7 17/32	9 1/8	11	13 15/16	13 15/16
b	1 7/16	1 11/16	1 15/16	2 3/8	2 25/32	3 3/16	4 7/16	4 13/16
c	2 5/32	2 5/16	2 5/8	3 3/32	4	5	6 11/16	6 11/16
d	1	1 3/16	1 3/8	1 3/4	2 1/8	3	4 1/4	4 1/4
e	3 5/16	3 15/16	4 9/16	5 5/16	6 1/2	8 9/16	10 7/8	10 7/8

Mark 9 LL & LR

Size	1/2	3/4	1	1 1/4	1 1/2	2	2 1/2	3	3 1/2	4
a	4 19/32	5 1/4	6 3/32	7 1/32	7 3/4	10 1/32	13 15/16	13 15/16	16 7/8	16 7/8
b	1 3/8	1 3/8	1 7/8	2 1/2	2 3/4	3 7/16	4 7/16	4 3/16	5 11/16	5 15/16
c	2 1/8	2 3/8	2 5/8	3 3/32	3 7/16	4 1/8	6 11/16	6 11/16	8 1/8	8 1/8
d	1 3/16	1 3/8	1 1/2	1 15/16	2 1/4	2 7/8	4 1/4	4 1/4	5 7/16	5 7/16
e	3 5/16	3 15/16	4 9/16	5 5/16	6	8 1/16	10 7/8	10 7/8	13 7/16	13 7/16

Crouse-Hinds

by E.T.N.

1F Condulet® Conduit Bodies - Cast Iron or Aluminum

Dimensions (In Inches)

1F

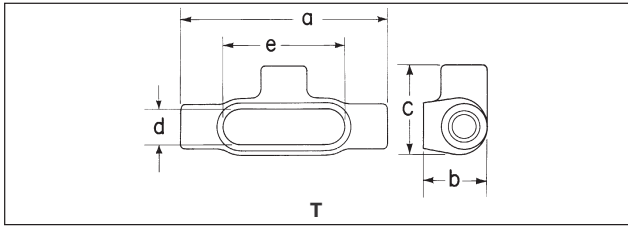

Form 7T

Size	a	b	c	d	e
1/2	5 ⁵ / ₈	1 ³ / ₄	2 ⁷ / ₁₆	1 ⁵ / ₁₆	3 ³ / ₁₆
3/4	6 ¹ / ₄	2	2 ⁵ / ₈	1 ¹ / ₈	3 ¹³ / ₁₆
1	7 ¹ / ₄	2 ¹ / ₄	3	1 ³ / ₈	4 ¹ / ₂
1 ¹ / ₄	7 ⁷ / ₁₆	2 ⁵ / ₁₆	3 ³ / ₁₆	1 ³ / ₄	5
1 ¹ / ₂	8 ³ / ₁₆	2 ⁹ / ₁₆	3 ³ / ₁₆	1 ¹⁵ / ₁₆	5 ⁷ / ₁₆
2	9 ⁹ / ₁₆	3 ¹ / ₈	4 ¹ / ₈	2 ⁷ / ₁₆	6 ³ / ₈
2 ¹ / ₂	12	3 ⁵ / ₈	5 ¹ / ₄	3 ³ / ₁₆	8 ³ / ₈
3	12 ¹ / ₁₆	4 ³ / ₈	5 ¹ / ₄	3 ³ / ₁₆	8 ³ / ₈
3 ¹ / ₂	14 ⁵ / ₁₆	4 ⁷ / ₈	6 ¹⁵ / ₁₆	4 ¹ / ₂	10 ¹ / ₄
4	14 ³ / ₁₆	5 ³ / ₈	6 ¹⁵ / ₁₆	4 ¹ / ₂	10 ¹ / ₄

Form 8T

1/2	5 ¹¹ / ₁₆	1 ³ / ₄	2 ⁵ / ₃₂	1	3 ⁵ / ₁₆
3/4	6 ⁹ / ₃₂	2	2 ⁹ / ₁₆	1 ³ / ₁₆	3 ¹⁵ / ₁₆
1	7 ⁵ / ₁₆	2 ¹ / ₄	2 ⁵ / ₈	1 ³ / ₈	4 ⁹ / ₁₆
1 ¹ / ₄	8 ¹ / ₂	2 ⁵ / ₈	3 ⁵ / ₃₂	1 ³ / ₄	5 ⁵ / ₁₆
1 ¹ / ₂	10 ⁹ / ₁₆	2 ²⁵ / ₃₂	4	2 ¹ / ₈	6 ¹ / ₂
2	12 ¹ / ₄	3 ⁹ / ₁₆	5	3	8 ⁷ / ₁₆
2 ¹ / ₂	15 ⁵ / ₈	4 ⁷ / ₁₆	6 ¹¹ / ₁₆	4 ¹ / ₄	10 ⁷ / ₈
3	15 ⁵ / ₈	4 ¹³ / ₁₆	6 ¹¹ / ₁₆	4 ¹ / ₄	10 ⁷ / ₈

Mark 9T

1/2	5	1 ³ / ₈	2 ¹ / ₈	1 ¹ / ₁₆	3 ⁵ / ₁₆
3/4	5 ¹¹ / ₁₆	1 ⁵ / ₈	2 ³ / ₈	1 ³ / ₈	3 ¹⁵ / ₁₆
1	6 ¹⁹ / ₃₂	1 ⁷ / ₈	2 ⁵ / ₈	1 ¹ / ₂	4 ⁹ / ₁₆
1 ¹ / ₄	7 ¹ / ₂	2 ¹ / ₂	3 ³ / ₃₂	1 ¹⁵ / ₁₆	5 ⁵ / ₁₆
1 ¹ / ₂	8 ¹ / ₄	2 ³ / ₄	3 ⁷ / ₁₆	2 ¹ / ₄	6
2	10 ¹ / ₂	3 ⁷ / ₁₆	4 ¹ / ₈	2 ⁷ / ₈	8 ¹ / ₁₆
2 ¹ / ₂	15 ⁵ / ₈	4 ⁷ / ₁₆	6 ¹¹ / ₁₆	4 ¹ / ₄	10 ⁷ / ₈
3	15 ⁵ / ₈	4 ¹³ / ₁₆	6 ¹¹ / ₁₆	4 ¹ / ₄	10 ⁷ / ₈
3 ¹ / ₂	18 ³ / ₄	5 ¹¹ / ₁₆	8 ¹ / ₈	5 ⁷ / ₁₆	13 ⁷ / ₁₆
4	18 ³ / ₄	5 ¹⁵ / ₁₆	8 ¹ / ₈	5 ⁷ / ₁₆	13 ⁷ / ₁₆

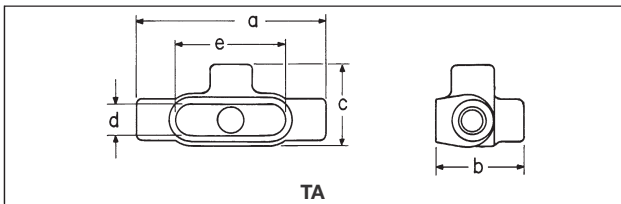

Form 7TA

Size	a	b	c	d	e
1/2	5 ⁵ / ₈	2 ⁵ / ₈	2 ⁷ / ₁₆	1 ⁵ / ₁₆	3 ³ / ₁₆
3/4	6 ¹ / ₄	2 ⁷ / ₈	2 ⁵ / ₈	1 ¹ / ₈	3 ¹³ / ₁₆
1	7 ¹ / ₄	3 ¹ / ₄	3	1 ³ / ₈	4 ¹ / ₂
1 ¹ / ₄	7 ⁷ / ₁₆	3 ⁵ / ₁₆	3 ³ / ₁₆	1 ³ / ₄	5
1 ¹ / ₂	8 ³ / ₁₆	3 ¹¹ / ₁₆	3 ³ / ₁₆	1 ¹⁵ / ₁₆	5 ⁷ / ₁₆
2	9 ⁹ / ₁₆	4 ¹ / ₄	4 ¹ / ₈	2 ⁷ / ₁₆	6 ³ / ₈

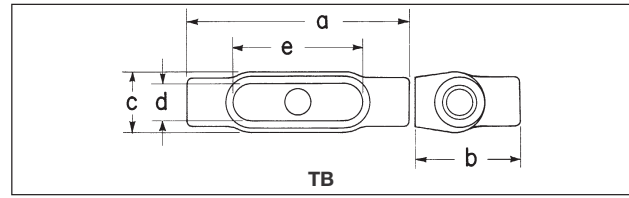

Form 7TB

Size	a	b	c	d	e
1/2	5 ⁵ / ₈	2 ⁵ / ₈	1 ⁹ / ₁₆	1 ⁵ / ₁₆	3 ³ / ₁₆
3/4	6 ¹ / ₄	2 ⁷ / ₈	1 ³ / ₄	1 ¹ / ₈	3 ¹³ / ₁₆
1	7 ¹ / ₄	3 ¹ / ₄	2	1 ³ / ₈	4 ¹ / ₂
1 ¹ / ₄	7 ⁷ / ₁₆	3 ⁵ / ₁₆	2 ³ / ₁₆	1 ³ / ₄	5
1 ¹ / ₂	8 ³ / ₁₆	5	2 ⁷ / ₁₆	1 ¹⁵ / ₁₆	5 ⁷ / ₁₆
2	9 ⁹ / ₁₆	6 ¹ / ₈	3	2 ⁷ / ₁₆	6 ³ / ₈

Form 8TB

1/2	5 ¹¹ / ₁₆	2 ¹⁷ / ₃₂	1 ³ / ₈	1	3 ⁵ / ₁₆
3/4	6 ⁹ / ₃₂	2 ³ / ₄	1 ⁹ / ₁₆	1 ³ / ₁₆	3 ¹⁵ / ₁₆
1	7 ⁵ / ₁₆	3 ¹ / ₈	1 ³ / ₄	1 ³ / ₈	4 ⁹ / ₁₆
1 ¹ / ₄	8 ¹ / ₂	3 ¹¹ / ₃₂	2 ³ / ₁₆	1 ³ / ₄	5 ⁵ / ₁₆
1 ¹ / ₂	10 ⁹ / ₁₆	4 ¹ / ₃₂	2 ³ / ₄	2 ¹ / ₈	6 ¹ / ₂
2	12 ¹ / ₄	4 ¹³ / ₁₆	3 ³ / ₄	3	8 ⁷ / ₁₆

Mark 9TB

1/2	5	2 ¹ / ₈	1 ³ / ₈	1 ³ / ₁₆	3 ⁵ / ₁₆
3/4	5 ¹¹ / ₁₆	2 ¹³ / ₃₂	1 ⁹ / ₁₆	1 ³ / ₈	3 ¹⁵ / ₁₆
1	6 ¹⁹ / ₃₂	2 ²⁷ / ₃₂	1 ³ / ₄	1 ¹ / ₂	4 ⁹ / ₁₆
1 ¹ / ₄	7 ¹ / ₂	3 ¹⁵ / ₃₂	2 ³ / ₁₆	1 ¹⁵ / ₁₆	5 ⁵ / ₁₆
1 ¹ / ₂	8 ¹¹ / ₃₂	3 ⁷ / ₈	2 ¹ / ₂	2 ⁵ / ₃₂	5 ⁷ / ₈
2	10 ⁵ / ₈	4 ¹⁹ / ₃₂	3 ⁷ / ₃₂	2 ¹⁵ / ₁₆	8 ³ / ₃₂

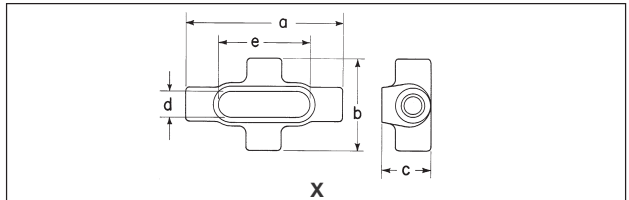

Form 7X

Size	a	b	c	d	e
1/2	5 ⁵ / ₈	3 ³ / ₁₆	1 ³ / ₄	1 ⁵ / ₁₆	3 ³ / ₁₆
3/4	6 ¹ / ₄	3 ¹ / ₂	2	1 ¹ / ₈	3 ¹³ / ₁₆
1	7 ¹ / ₄	4	2 ¹ / ₄	1 ³ / ₈	4 ¹ / ₂
1 ¹ / ₄	7 ⁷ / ₁₆	4 ¹ / ₈	2 ³ / ₁₆	1 ³ / ₄	5
1 ¹ / ₂	8 ³ / ₁₆	4 ⁵ / ₈	2 ³ / ₁₆	1 ¹⁵ / ₁₆	5 ⁷ / ₁₆
2	9 ⁹ / ₁₆	5 ³ / ₁₆	3 ¹ / ₈	2 ⁷ / ₁₆	6 ³ / ₈

Form 8X

1/2	5 ¹¹ / ₁₆	2 ²⁹ / ₃₂	1 ³ / ₄	1	3 ⁵ / ₁₆
3/4	6 ⁹ / ₃₂	3 ¹ / ₁₆	2	1 ³ / ₁₆	3 ¹⁵ / ₁₆
1	7 ⁵ / ₁₆	3 ¹ / ₂	2 ¹ / ₄	1 ³ / ₈	4 ⁹ / ₁₆
1 ¹ / ₄	8 ¹ / ₂	4 ¹ / ₈	2 ⁵ / ₈	1 ³ / ₄	5 ⁵ / ₁₆
1 ¹ / ₂	10 ⁹ / ₁₆	5 ¹ / ₄	2 ¹⁵ / ₃₂	2 ¹ / ₈	6 ¹ / ₂
2	12 ¹ / ₄	6 ¹ / ₄	3 ⁹ / ₁₆	3	8 ⁷ / ₁₆

Mark 9X

1/2	5 ¹¹ / ₁₆	2 ²⁹ / ₃₂	1 ³ / ₄	1	3 ⁵ / ₁₆
3/4	6 ⁹ / ₃₂	3 ¹ / ₁₆	2	1 ³ / ₁₆	3 ¹⁵ / ₁₆
1	7 ⁵ / ₁₆	3 ¹ / ₂	2 ¹ / ₄	1 ³ / ₈	4 ⁹ / ₁₆

Crouse-Hinds
by **E.T.N**