

Maestro® Occupancy Sensing Switch

Lutron® Maestro® Occupancy Sensing switches with occupancy and vacancy sensors are lighting controls with passive infrared sensors that automatically control the lights in an area. These sensors detect the heat from occupants moving within an area to determine when the space is occupied. The Occupancy Sensing switch combines a Maestro® switch with an occupancy or vacancy sensor.

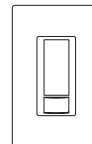

Family Features

- Passive infrared motion detection with exclusive Lutron® XCT™ Technology for fine motion detection
- Neutral wire is required
- 180° sensor field-of-view
- Up to 30 ft x 30 ft (9 m x 9 m) [900 ft² (81 m²)] major motion coverage and 20 ft x 20 ft (6 m x 6 m) [400 ft² (36 m²)] minor motion coverage 180° field-of-view
- Occupancy version can be set to auto-on/auto-off or manual-on/auto-off
- Vacancy version available to meet CA title 24 requirements
- Adjustable timeout – 1, 5, 15, or 30 minutes
- High-low sensitivity adjustment
- Occupancy Sensing switch lighting loads: incandescent, halogen, MLV, ELV, CFL, LED, magnetic fluorescent, and electronic fluorescent
- Works with a single standard 3-way switch or up to 9 companion switches (MA-AS-XX, MSC-AS-XX, MA-AS-277-XX, or MSC-AS-277-XX**). Standard 3-way switch cannot be combined with companion switch. Total blue terminal wire length may be up to 150 ft (46 m).

** XX in model number represents color/finish code

Occupancy Sensing switch:

MS-OPS6M2N-DV-XX	Occupancy /vacancy single-pole /multi-location 120-277 V~	Auto-on /auto-off or manual-on /auto-off	6 A lighting (120-277 V~) 3 A fan (120 V~ only)
MS-VPS6M2N-DV-XX	Vacancy single-pole multi-location 120-277 V~	Manual-on / auto-off	6 A lighting (120-277 V~) 3 A fan (120 V~ only)

* For additional Maestro® Occupancy Sensing switch options, see Lutron P/N 369270 (model number: MS-OPS6M-DV) and P/N 369488 (MS-OPS2, MS-OPS5M, and MS-OPS6M2-DV).

Job Name:	Model Numbers:
Job Number:	

Colors and Finishes

Gloss Finishes

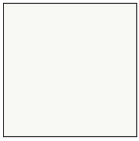

White
WH



Ivory
IV

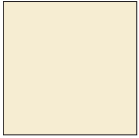

Almond
AL



Light
Almond
LA

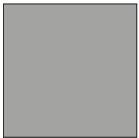

Gray
GR

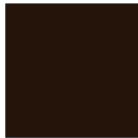

Brown
BR



Black
BL

Satin Finishes



Hot
HT



Merlot
MR



Plum
PL



Turquoise
TQ



Taupe
TP



Eggshell
ES



Biscuit
BI



Snow
SW



Palladium
PD



Midnight
MN



Sienna
SI

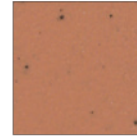

Terracotta
TC



Greenbriar
GB

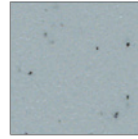

Bluestone
BG

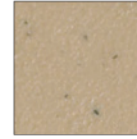

Mocha
Stone
MS

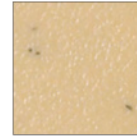

Goldstone
GS



Desert Stone
DS

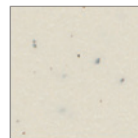

Stone
ST



Limestone
LS

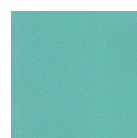

Sea Glass
SG

Due to printing limitations, colors and finishes shown cannot be guaranteed to perfectly match actual product colors.

Job Name:	Model Numbers:
Job Number:	

Load Type and Capacity

Control	Voltage	Load Type	Minimum Load	Maximum Load			Neutral Connection Required
				Not Ganged	End of Gang	Middle of Gang	
MS-OPS6M2N-DV MS-VPS6M2N-DV	120-277 V~	Lighting ^{1,2}	0 A	6 A	6 A	6 A	YES
	120 V~	Fan ²	0 A (0 HP)	3 A (1/10 HP)	3 A (1/10 HP)	3 A (1/10 HP)	YES

¹ Occupancy Sensing switch Load Type: designed for use with permanently installed incandescent, halogen, MLV, ELV, CFL, LED, magnetic fluorescent, and electronic fluorescent lighting loads.

² When controlling light and fan loads simultaneously, maximum load capacity is 3 A at 120 V~ only.

Additional Information

- For additional Maestro® Occupancy Sensing switch models, please see Lutron P/N 369270 (model number: MS-OPS6M-DV) and P/N 369488 (MS-OPS2, MS-OPS5M, and MS-OPS6M2-DV).
- For use with MA-AS or for control from more than two locations, please see Lutron P/N 048435.
- For more information on the model numbers in this document, please see www.lutron.com/occvacensors.
- Lutron Technical Hotline: 1.800.523.9466.

Job Name:	Model Numbers:
Job Number:	

Specifications

Regulatory Approvals

- UL Listed to U.S. and Canadian safety requirements.
- NOM Certification (pending).

Power

Operating voltage:
120-277 V~ 50/60 Hz

Key Design Features

- All lighting loads.
- Crush/tamper resistant lens.
- Smart ambient light detection. Lights turn on only if ambient light in the room is low. Automatically learns user's preferred setting.
- Adaptive switching algorithm for extended relay life.
- XCT™ Technology for fine motion detection.

Environment

- Ambient operating temperature: 32 °F to 104 °F (0 °C to 40 °C), 0%-90% humidity, non-condensing. Indoor use only.

Warranty

- 5 Year Limited Warranty.
For additional Warranty information, please visit http://www.lutron.com/TechnicalDocumentLibrary/Sensor_Warranty.pdf

Timeout Options

- 1 Minute
- 5 Minutes
- 15 Minutes
- 30 Minutes

Sensitivity Options

- High sensitivity
- Low sensitivity

Auto-On Options (MS-OPS models only)

- "Occupancy" – Auto-On/Auto-Off
- "Vacancy"* – Manual-On/Auto-Off
- "Low Light" – Lights turn on only if needed (if ambient light is below threshold)

* There is a 15-second grace period that begins when the lights are automatically turned off, during which the lights will automatically turn back on in response to motion. This grace period is provided as a safety and convenience feature in the event the lights turn off while the room is still occupied, so that the user does not need to manually turn the lights back on. After 15 seconds, the grace period expires and the lights must be manually turned on.

Manual Off While Occupied Options (MS-OPS models only)

ENABLED

(default setting for MS-OPS6M2N-DV)

- When the Occupancy Sensing switch is manually turned off, the Occupancy Sensing switch will not turn the lights back on automatically while the room is occupied.
- Once the room is vacated, the Auto-on feature returns to normal operation after the timeout period has expired.
- This may be the preference in conference rooms or classrooms while viewing presentations. This feature requires motion to keep the lights off.

DISABLED

- When the Occupancy Sensing switch is manually turned off, the Auto-on feature will return to normal operation after 25 seconds.
- This may be the preference if the user always wants the lights to turn on upon entering and the lights to turn off when the room is vacant.

Job Name:	Model Numbers:
Job Number:	

Beam Diagrams

Horizontal Beam Diagram

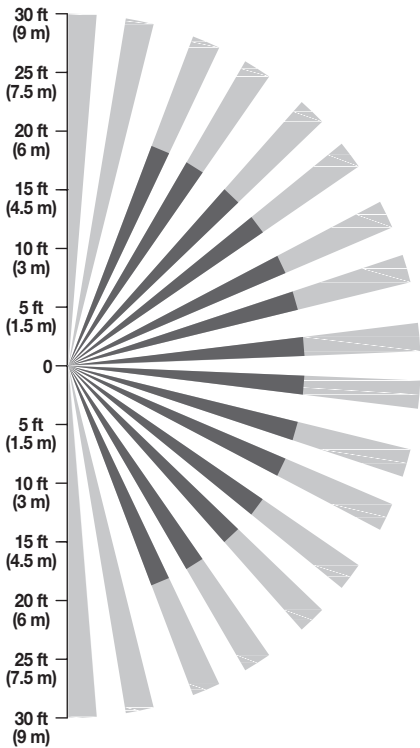

Vertical Beam Diagram

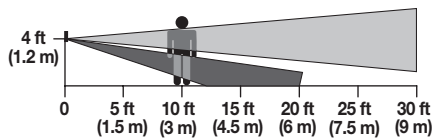

Tested Coverage Area

- Major Motion 900 ft² (81 m²) coverage
- Major Motion 400 ft² (36 m²) coverage

Compliant to NEMA WD7 test grid shown below

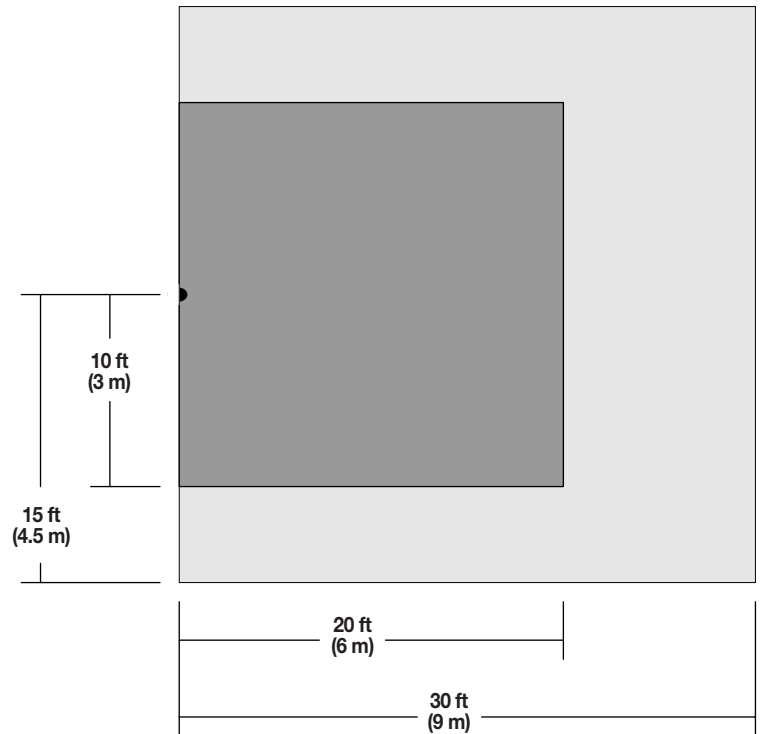

Occupancy Sensing switch Placement and Operation

- The ability of the Occupancy Sensing switch to detect motion requires line-of-sight of room occupants. The Occupancy Sensing switch must have an unobstructed view of the room.
- Hot objects and moving air currents can affect the performance of the Occupancy Sensing switch.
- The performance of the Occupancy Sensing switch depends on a temperature differential between the ambient room temperature and that of room occupants. Warmer rooms may reduce the ability of the Occupancy Sensing switch to detect occupants.

Job Name:	Model Numbers:
Job Number:	

Operation

Occupancy Sensing switch

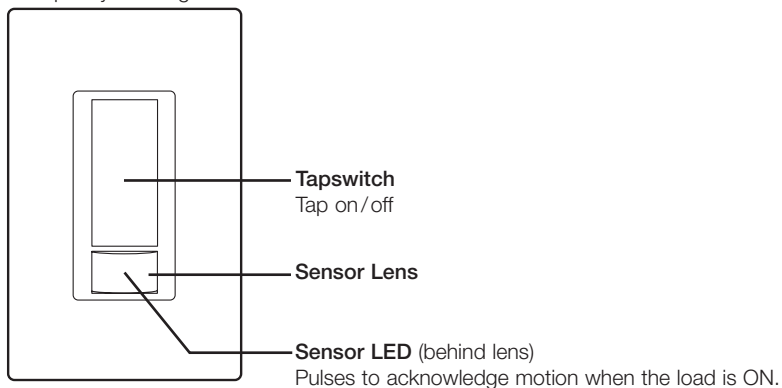

Mounting

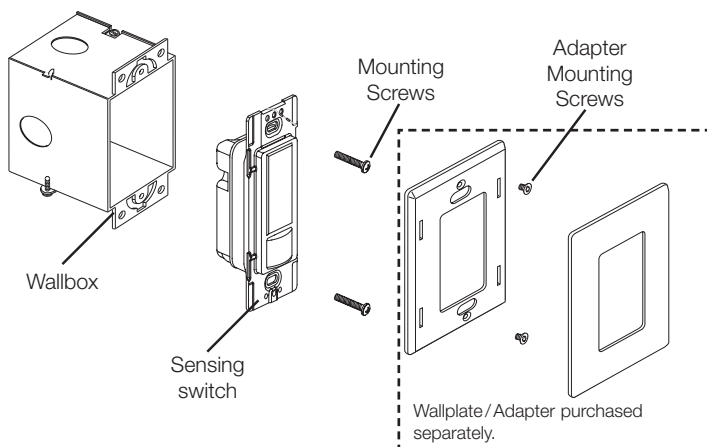

Job Name:	Model Numbers:
Job Number:	

Dimensions

Measurements shown as: in (mm)

Front View

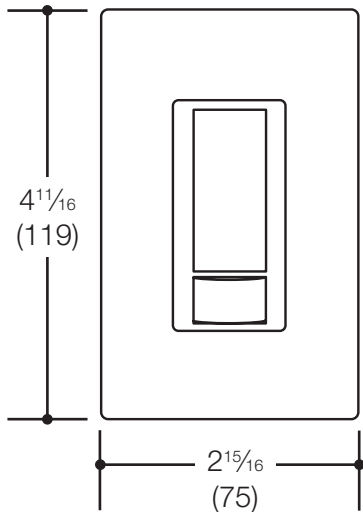

Side View

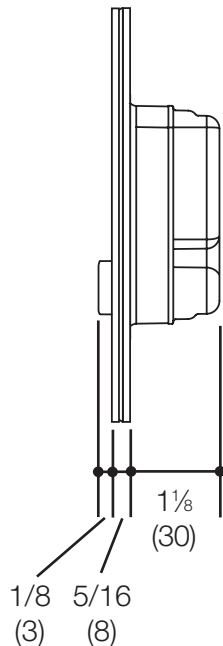

Ganging and Derating

Occupancy Sensing switches can be ganged without derating.

Job Name:	Model Numbers:
Job Number:	

Wiring Diagrams:

Wiring Diagram 1

Single Location Installation (120-277 V~)^{1,3}

-OPS6M2N-DV, -VPS6M2N-DV

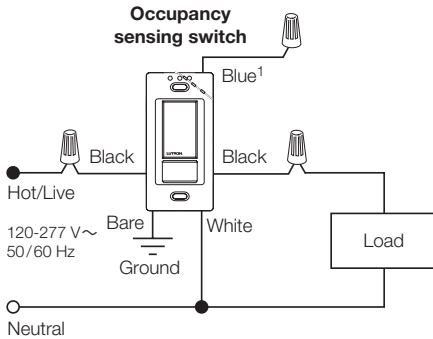

Wiring Diagram 2

3-way Installation with Standard Mechanical Switch (120 V~)^{2,4}

-OPS6M2N-DV, -VPS6M2N-DV

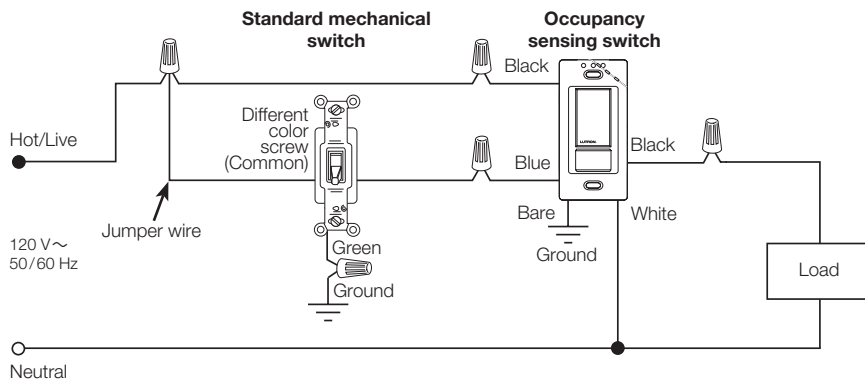

OR

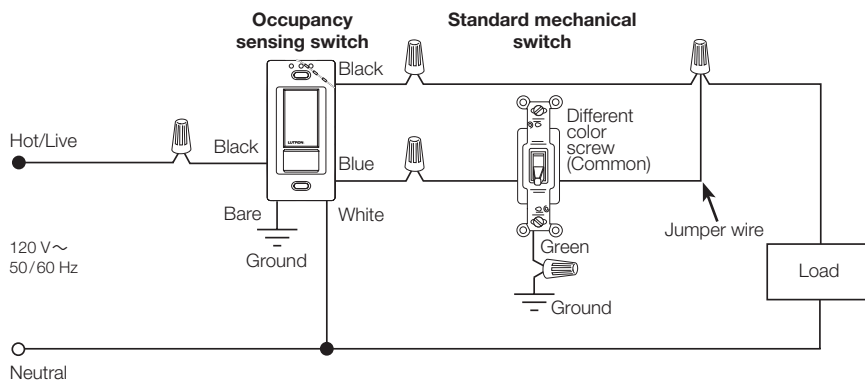

- 1 When using controls in single location installations, tighten the blue terminal or cap blue wire. **Do not** connect the blue terminal/wire to any other wire or to ground.
- 2 Only one Occupancy Sensing switch can be used per multi-location circuit.
- 3 Fan load applies to 120 V~ only (Not for 277 V~)
- 4 A single standard 3-way switch or up to 9 companion switches may be connected to an Occupancy Sensing switch. Standard 3-way switch cannot be combined with companion switch. Total blue terminal wire length may be up to 150 ft (46 m).

Job Name:	Model Numbers:
Job Number:	

Wiring Diagrams: (continued)

Wiring Diagram 3

3-way Installation with Standard Mechanical Switch (277 V~)^{1, 2, 3}

-OPS6M2N-DV, -VPS6M2N-DV

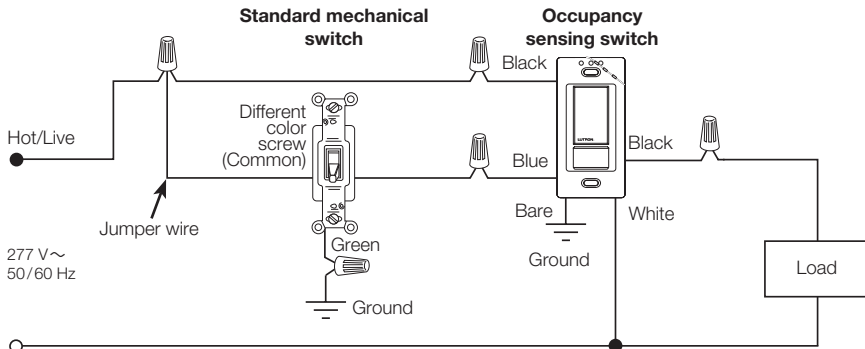

OR

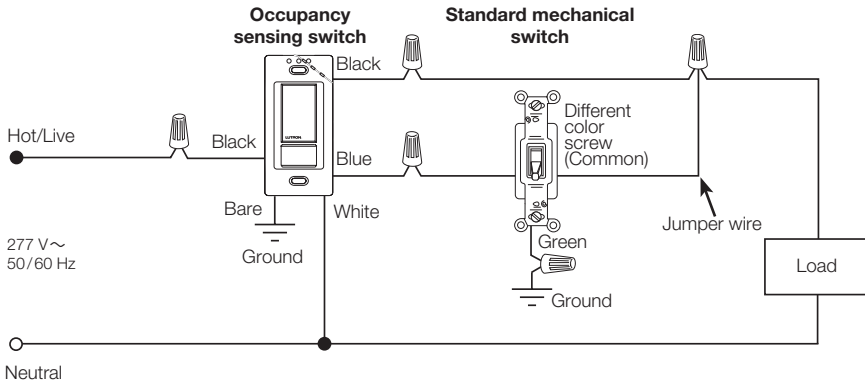

Wiring Diagram 4

Multi-Location Installation (120 V~)^{1, 2, 3, 4}

-OPS6M2N-DV, -VPS6M2N-DV with MA-AS or MSC-AS

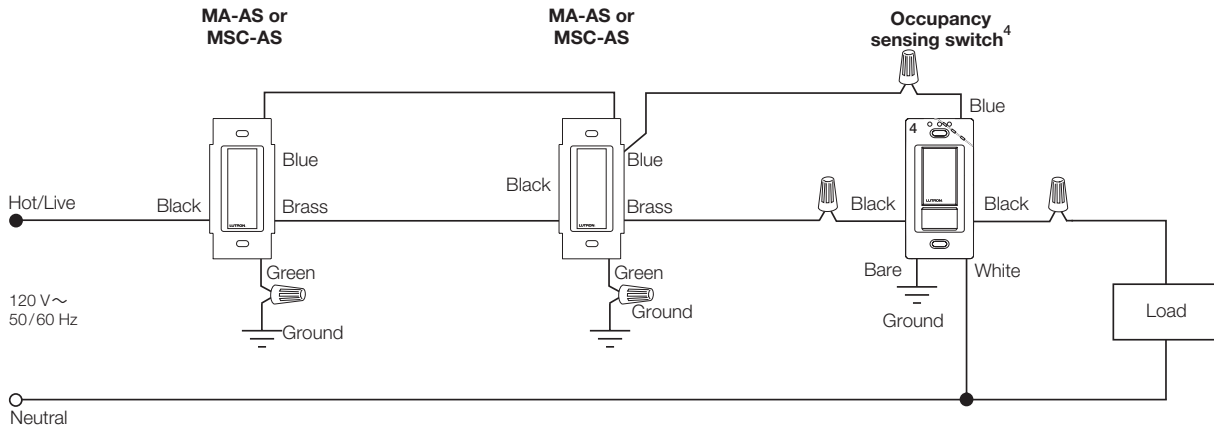

- 1 A single standard 3-way switch or up to 9 companion switches may be connected to an Occupancy Sensing switch. Standard 3-way switch cannot be combined with companion switch. Total blue terminal wire length may be up to 150 ft (46 m)
- 2 Only one Occupancy Sensing switch can be used per multi-location circuit.
- 3 Fan load applies to 120 V~ only (Not for 277 V~).
- 4 Note: Can be installed in any location.

Job Name:	Model Numbers:
Job Number:	

Wiring Diagram 5

Multi-Location Installation (277 V~)^{1, 2, 3, 4}

-OPS6M2N-DV, -VPS6M2N-DV with MA-AS-277 or MSC-AS-277

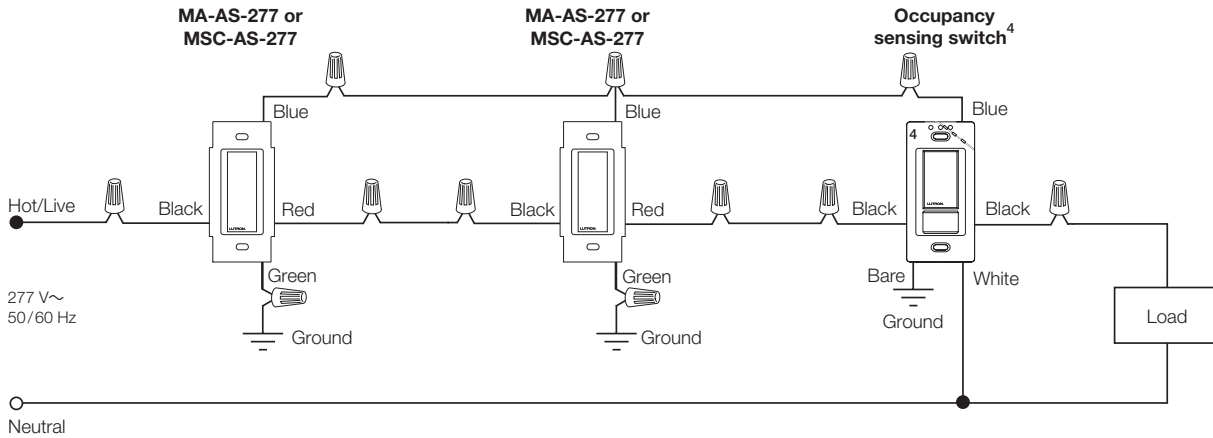

- 1 A single standard 3-way switch or up to 9 companion switches may be connected to an Occupancy Sensing switch. Standard 3-way switch cannot be combined with companion switch. Total blue terminal wire length may be up to 150 ft (46 m)
- 2 Only one Occupancy Sensing switch can be used per multi-location circuit.
- 3 Fan load applies to 120 V~ only (Not for 277 V~).
- 4 Note: Can be installed in any location.

Job Name:	Model Numbers:
Job Number:	