



Recessed Floor Boxes for Concrete

RFBA2C, RFBA4C, RFBA6C, RFBA10C

RFBA Series of Floor Boxes with round activations are versatile recessed activation solutions that provide power, communication and/or audio/video services to open space areas, or directly to workstations. The floor boxes come in various sizes and depths, including 2, 4, 6 and 10-gangs to best fit your specific application. The round activation boxes utilize existing Evolution™ series round covers and are designed to sit on top or flush with finished floor surfaces, such as carpet, tile, wood flooring, polished concrete or terrazzo. The RFBA series includes improved wire and cable routing, allowing for easier wire pulling in adjacent compartments and around corners.

The RFBA floor box is built for multiple applications and environments

Features & Benefits

- **Suitable for Various Applications.** Steel and on-grade (epoxy coated) to meet your specific installation requirements with support for installation in carpet, wood flooring, tile, terrazzo and polished concrete.
- **Various Gang and Depth Options Available.** Choose from either 2, 4, 6 or 10-gang boxes to fit your application. The 2 and 4-gang options are available in either a shallow (3.25") depth or standard (3.75") depth box.
- **Common Mounting Plates.** All models share the same mounting plates, allowing for easier configuration and specification.
- **Numerous Conduit Knockouts.** Features knockouts on all sides and bottom of box to allow for greater installation flexibility to work within your environment.
- **Utilizes Evolution™ Series Round Covers.** Choose from a wide range of die-cast aluminum cover assemblies, available in powder coated finishes of black, gray and bronze, as well as durable finishes with brushed aluminum, satin brass plated and satin nickel plated.
- **Improved Cable Management.** Internal compartments feature improved wire and cable routing for easier wire pulling in adjacent compartments and around corners.
- **Post-Pour Features:** Allows for adjustment post-pour and features removable dividers that can be installed or removed before or after the concrete pour.

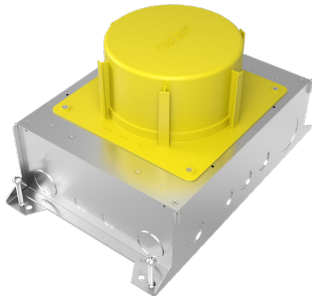

Round extension ring can be used to extend height of box up to 4 inches

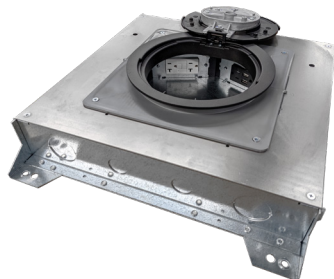

All models share eight (8) common device plates, allowing for data and power within the same box



Compatible with existing Evolution Series die-cast aluminum covers. Choose from powder coated finishes or durable finishes.

Compliance



cULus Listed: Metallic Outlet Boxes for tile, terrazzo, carpet and wood floors.
File E2961 Guide QCIT

RFBA Series Round Activation Floor Boxes Ordering Information

Box Model	Box Type	Box Capacity	Box Depth	Conduit Size	Cover Style
RFBA2C25	Above Grade	2-Gang	3.25"	¾" - 1 ¼"	Evolution 6" Round Covers
RFBA2C25OG	On-Grade	2-Gang	3.25"	¾" - 1 ¼"	Evolution 6" Round Covers
RFBA2C30	Above Grade	2-Gang	3.75"	¾" - 2"*	Evolution 6" Round Covers
RFBA2C30OG	On-Grade	2-Gang	3.75"	¾" - 2"*	Evolution 6" Round Covers
RFBA4C25	Above Grade	4-Gang	3.25"	¾" - 1 ½"	Evolution 6" Round Covers
RFBA4C25OG	On-Grade	4-Gang	3.25"	¾" - 1 ½"	Evolution 6" Round Covers
RFBA4C30	Above Grade	4-Gang	3.75"	¾" - 2"*	Evolution 6" Round Covers
RFBA4C30OG	On-Grade	4-Gang	3.75"	¾" - 2"*	Evolution 6" Round Covers
RFBA6C30	Above Grade	6-Gang	3.75"	¾" - 2"*	Evolution 8" Round Covers
RFBA6C30OG	On-Grade	6-Gang	3.75"	¾" - 2"*	Evolution 8" Round Covers
RFBA10C55	Above Grade	10-Gang	6.25"	¾" - 2"	Evolution 8" Round Covers
RFBA10C55OG	On-Grade	10-Gang	6.25"	¾" - 2"	Evolution 8" Round Covers

* Additional 2HUB accessory is needed on the 2, 4 and 6-gang boxes if using a 2" conduit feed to the box. Largest knockout without the 2HUB accessory on the 2, 4 and 6-gang boxes is 1 ¼".

RFBA Series Round Activation Floor Boxes Ordering Information

RFBA2C25

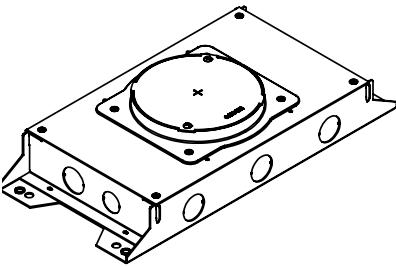

RFBA 2-Gang Round Floor Box, Shallow 3.25" Depth – Steel floor box designed for above grade installations. Features 2-gangs of box capacity with at least 3 ⅙" available behind device plates. Fully adjustable before and after concrete pour. Designed for carpet, wood flooring, tile, terrazzo and polished concrete and applications. Use with Evolution™ Series 6" round covers. When ordering device plates for box, 2 blank device plates (Cat. No. RFBAB) must also be ordered to seal of wire and cable routing passageways.

Concrete Pour: Minimum concrete pour is 3.25"

Sold Separately:

- Evolution™ Series 6CTC & 6CT Round Covers
- Device Plates

RFBA2C25OG

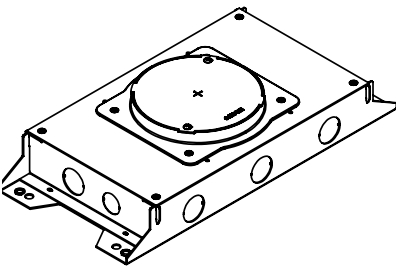

RFBA 2-Gang On-Grade Round Floor Box, Shallow 3.25" Depth – Steel floor box designed for on-grade installations with a fusion-bonded epoxy for use on metal reinforcement bar and related accessories before encapsulating in concrete. Features 2-gangs of box capacity with at least 3 ⅙" available behind device plates. Fully adjustable before and after concrete pour. Designed for carpet, wood flooring, tile, terrazzo and polished concrete applications. Use with Evolution™ Series 6" round covers. When ordering device plates for box, 2 blank device plates (Cat. No. RFBAB) must also be ordered to seal of wire and cable routing passageways.

Concrete Pour: Minimum concrete pour is 3.25"

Sold Separately:

- Evolution™ Series 6CTC & 6CT Round Covers
- Device Plates

Dimensions:

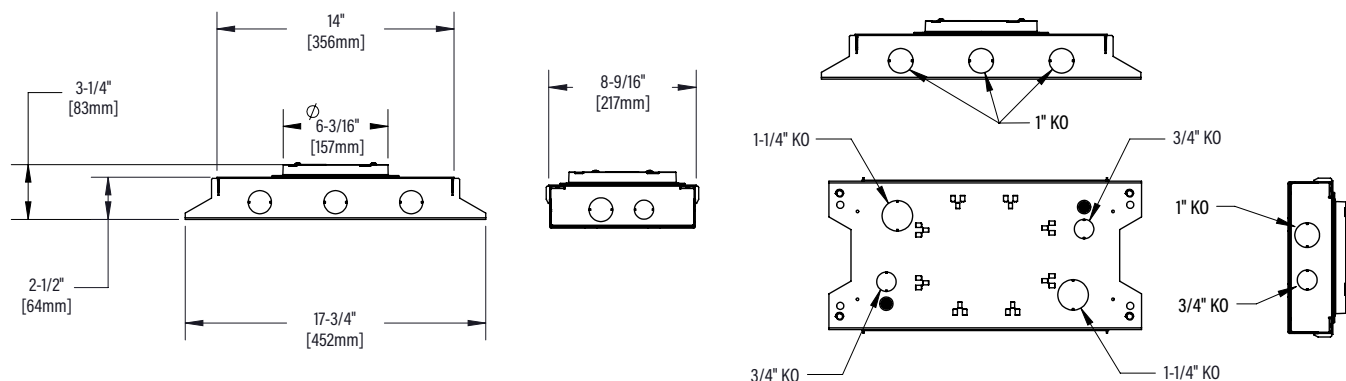

RFBA Series Round Activation Floor Boxes Ordering Information

RFBA2C30

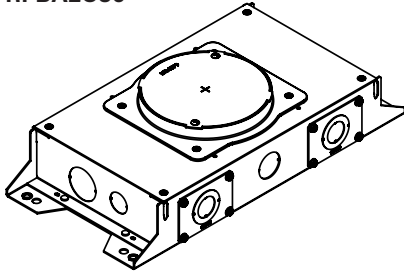

RFBA 2-Gang Round Floor Box, Standard 3.75" Depth – Steel floor box designed for above grade installations. Features 2-gangs of box capacity with at least 3 1/16" available behind device plates. Fully adjustable before and after concrete pour. Designed for carpet, wood flooring, tile, terrazzo and polished concrete applications. Use with Evolution™ Series 6" round covers. When ordering device plates for box, 2 blank device plates (Cat. No. RFBAB) must also be ordered to seal of wire and cable routing passageways.

Concrete Pour: Minimum concrete pour is 3.75"

Sold Separately:

- Evolution™ Series 6CTC & 6CT Round Covers
- Device Plates

RFBA2C30OG RFBA2C30OG-NA*

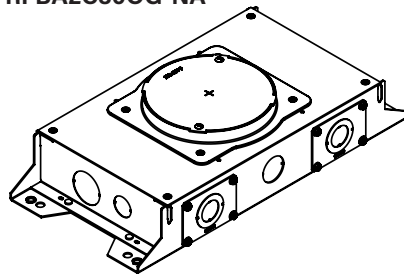

RFBA 2-Gang On-Grade Round Floor Box, Standard 3.75" Depth – Steel floor box designed for on-grade installations with a fusion-bonded epoxy for use on metal reinforcement bar and related accessories before encapsulating in concrete. Features 2-gangs of box capacity with at least 3 1/16" available behind device plates. Fully adjustable before and after concrete pour. Designed for carpet, wood flooring, tile, terrazzo and polished concrete applications. Use with Evolution™ Series 6" round covers. When ordering device plates for box, 2 blank device plates (Cat. No. RFBAB) must also be ordered to seal of wire and cable routing passageways.

Concrete Pour: Minimum concrete pour is 3.75"

Sold Separately:

- Evolution™ Series 6CTC & 6CT Round Covers
- Device Plates

*OG version available as BAA compliant product by adding -NA

Dimensions:

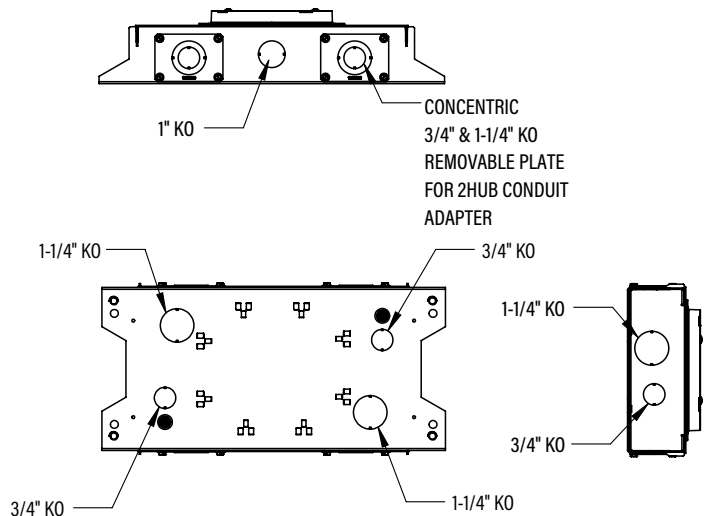
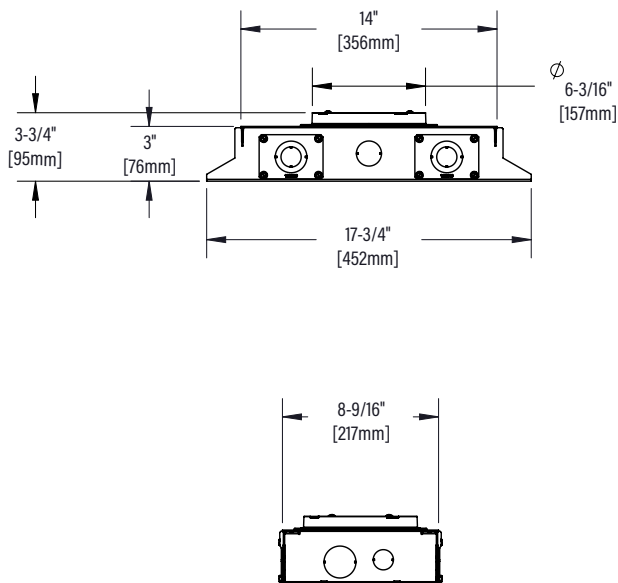

RFBA Series Round Activation Floor Boxes Ordering Information

RFBA4C25

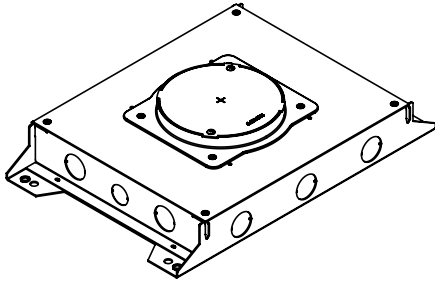

RFBA 4-Gang Round Floor Box, Shallow 3.25" Depth - Steel floor box designed for above grade installations. Features 4-gangs of box capacity with at least 2 9/16" available behind device plates. Fully adjustable before and after concrete pour. Designed for carpet, wood flooring, tile, terrazzo and polished concrete applications. Use with Evolution™ Series 6" round covers.

Concrete Pour: Minimum concrete pour is 3.25"

Sold Separately:

- Evolution™ Series 6CTC & 6CT Round Covers
- Device Plates

RFBA4C25OG

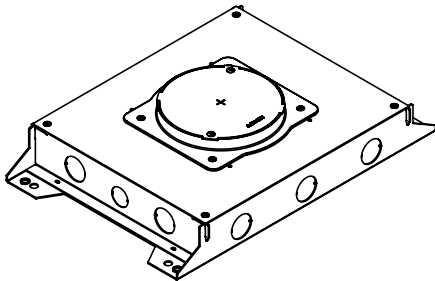

RFBA 4-Gang On-Grade Round Floor Box, Shallow 3.25" Depth - Steel floor box designed for on-grade installations with a fusion-bonded epoxy for use on metal reinforcement bar and related accessories before encapsulating in concrete. Features 4-gangs of box capacity with at least 2 9/16" available behind device plates. Fully adjustable before and after concrete pour. Designed for carpet, wood flooring, tile, terrazzo and polished concrete applications. Use with Evolution™ Series 6" round covers.

Concrete Pour: Minimum concrete pour is 3.25"

Sold Separately:

- Evolution™ Series 6CTC & 6CT Round Covers
- Device Plates

Dimensions:

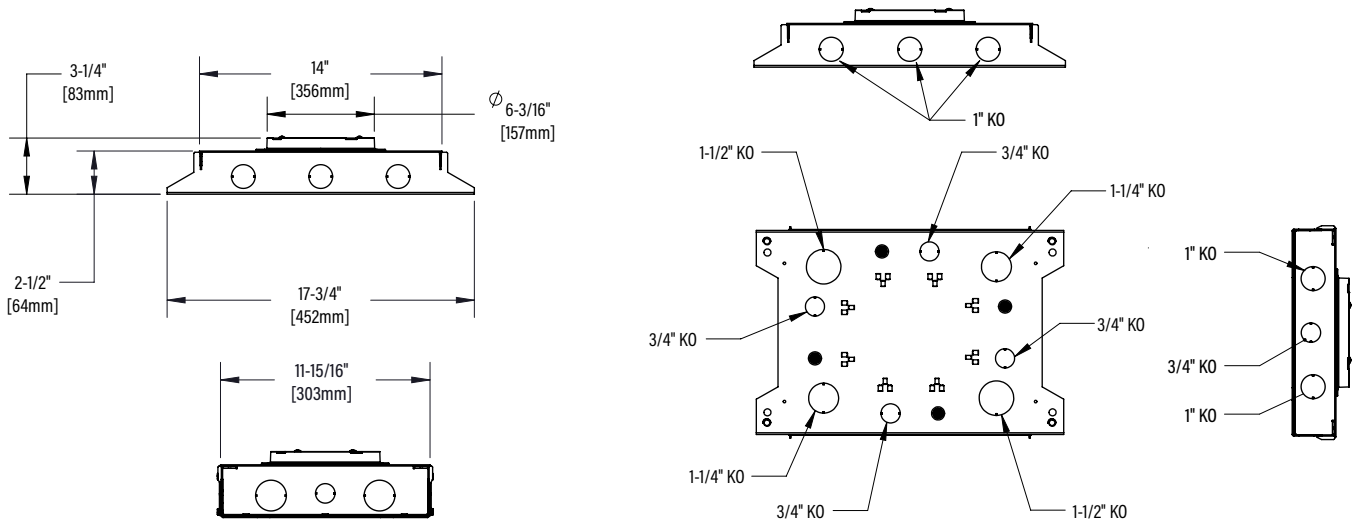

RFBA Series Round Activations Floor Boxes Ordering Information

RFBA4C30

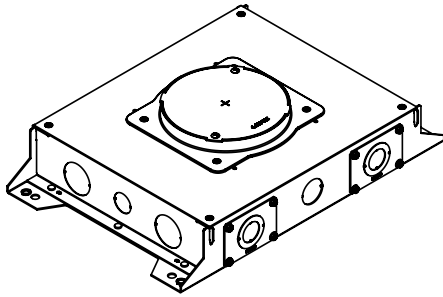

RFBA 4-Gang Round Floor Box, Standard 3.75" Depth - Steel floor box designed for above grade installations. Features 4-gangs of box capacity with at least 2 9/16" available behind device plates. Fully adjustable before and after concrete pour. Designed for carpet, wood flooring, tile, terrazzo and polished concrete applications. Use with Evolution™ Series 6" round covers.

Concrete Pour: Minimum concrete pour is 3.75"

Sold Separately:

- Evolution™ Series 6CTC & 6CT Round Covers
- Device Plates

RFBA4C30OG RFBA4C30OG-NA*

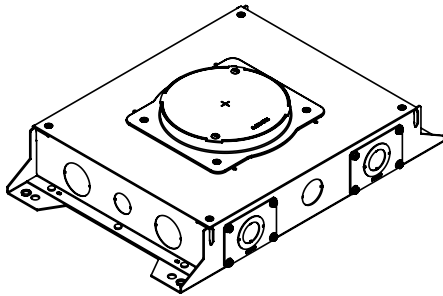

RFBA 4-Gang On-Grade Round Floor Box, Standard 3.75" Depth - Steel floor box designed for on-grade installations with a fusion-bonded epoxy for use on metal reinforcement bar and related accessories before encapsulating in concrete. Features 4-gangs of box capacity with at least 2 9/16" available behind device plates. Fully adjustable before and after concrete pour. Designed for carpet, wood flooring, tile, terrazzo and polished concrete applications. Use with Evolution™ Series 6" round covers.

Concrete Pour: Minimum concrete pour is 3.75"

Sold Separately:

- Evolution™ Series 6CTC & 6CT Round Covers
- Device Plates

*OG version available as BAA compliant product by adding -NA

Dimensions:

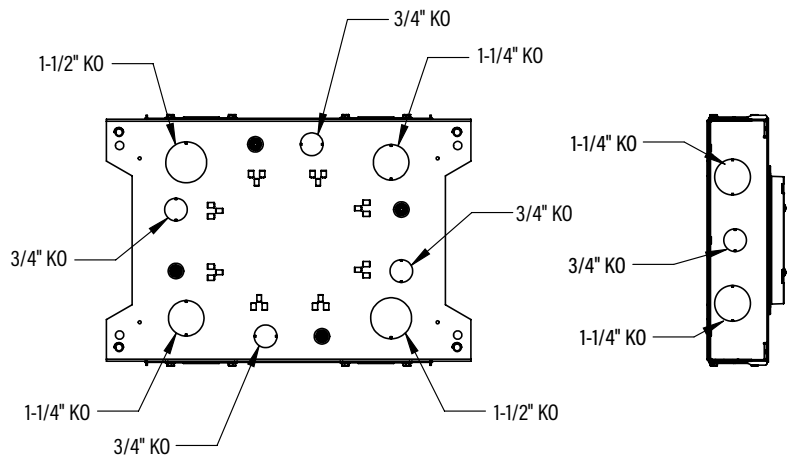
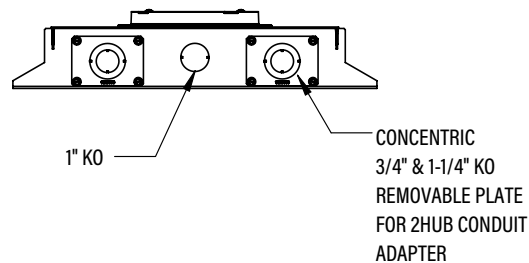
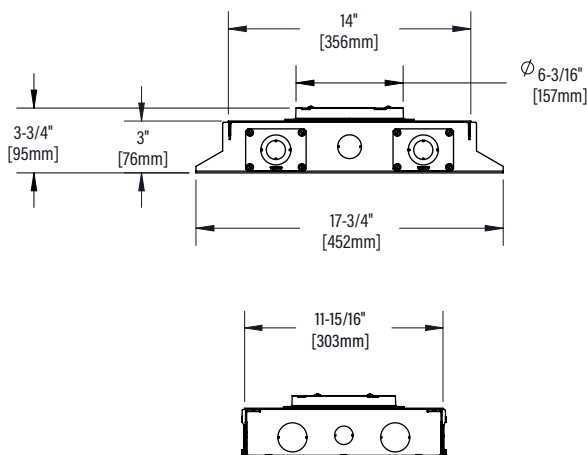

RFBA Series Round Activation Floor Boxes Ordering Information

RFBA6C30

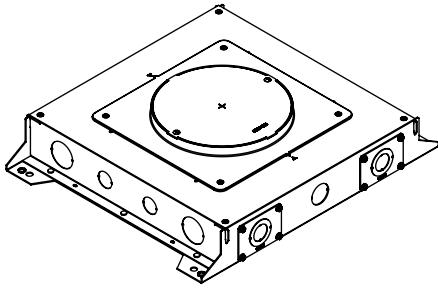

RFBA 6-Gang Round Floor Box, Standard 3.75" Depth - Steel floor box designed for above grade installations. Features 6-gangs of box capacity with at least 2 9/16" available behind device plates. Fully adjustable before and after concrete pour. Designed for carpet, wood flooring, tile, terrazzo and polished concrete applications. Use with Evolution™ Series 8" round covers.

Concrete Pour: Minimum concrete pour is 3.75"

Sold Separately:

- Evolution™ Series 8CTC & 8CT Round Covers
- Device Plates

RFBA6C30OG
RFBA6C30OG-NA*

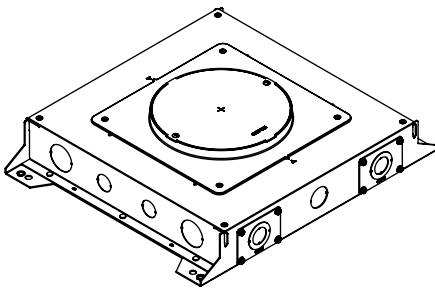

RFBA 6-Gang Round On-Grade Floor Box, Standard 3.75" Depth - Steel floor box designed for on-grade installations with a fusion-bonded epoxy for use on metal reinforcement bar and related accessories before encapsulating in concrete. Features 6-gangs of box capacity with at least 2 9/16" available behind device plates. Fully adjustable before and after concrete pour. Designed for carpet, wood flooring, tile, terrazzo and polished concrete applications. Use with Evolution™ Series 8" round covers.

Concrete Pour: Minimum concrete pour is 3.75"

Sold Separately:

- Evolution™ Series 8CTC & 8CT Round Covers
- Device Plates

*OG version available as BAA compliant product by adding -NA

Dimensions:

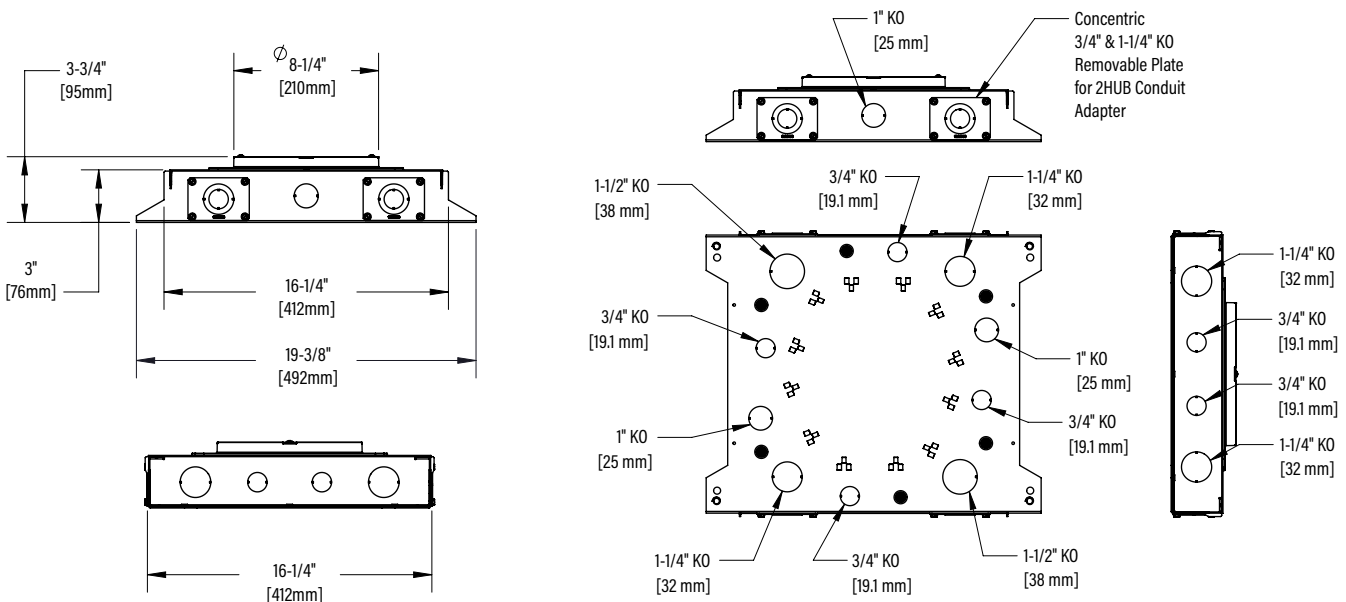

RFBA Series Round Activation Floor Boxes Ordering Information

RFBA10C55

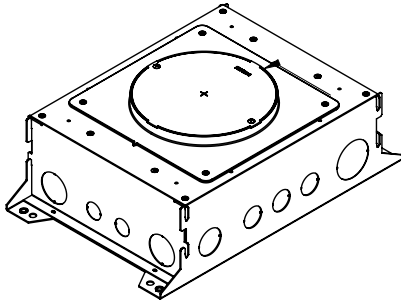

RFBA 10-Gang Round Floor Box, 6.25" Depth - Steel floor box designed for above grade installations. Features 10-gangs of box capacity with at least 2 1/2" available behind device plates. Fully adjustable before and after concrete pour. Designed for carpet, wood flooring, tile, terrazzo and polished concrete applications. Use with Evolution™ Series 8" round covers.

Sold Separately:

- Evolution™ Series 8CTC & 8CT Round Covers
- Device Plates

RFBA10C55OG RFBA10C55OG-NA*

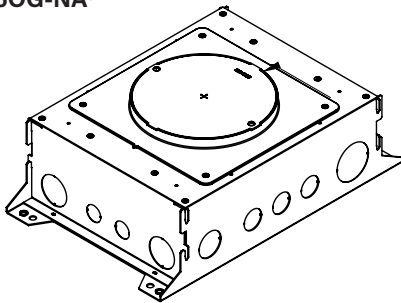

RFBA 10-Gang Round On-Grade Floor Box, 6.25" Depth - Steel floor box designed for on-grade installations with a fusion-bonded epoxy for use on metal reinforcement bar and related accessories before encapsulating in concrete. Features 10-gangs of box capacity with at least 2 1/2" available behind device plates. Fully adjustable before and after concrete pour. Designed for carpet, wood flooring, tile, terrazzo and polished concrete applications. Use with Evolution™ Series 8" round covers.

Concrete Pour: Minimum concrete pour is 6.25"

Sold Separately:

- Evolution™ Series 8CTC & 8CT Round Covers
- Device Plates

*OG version available as BAA compliant product by adding -NA

Dimensions:

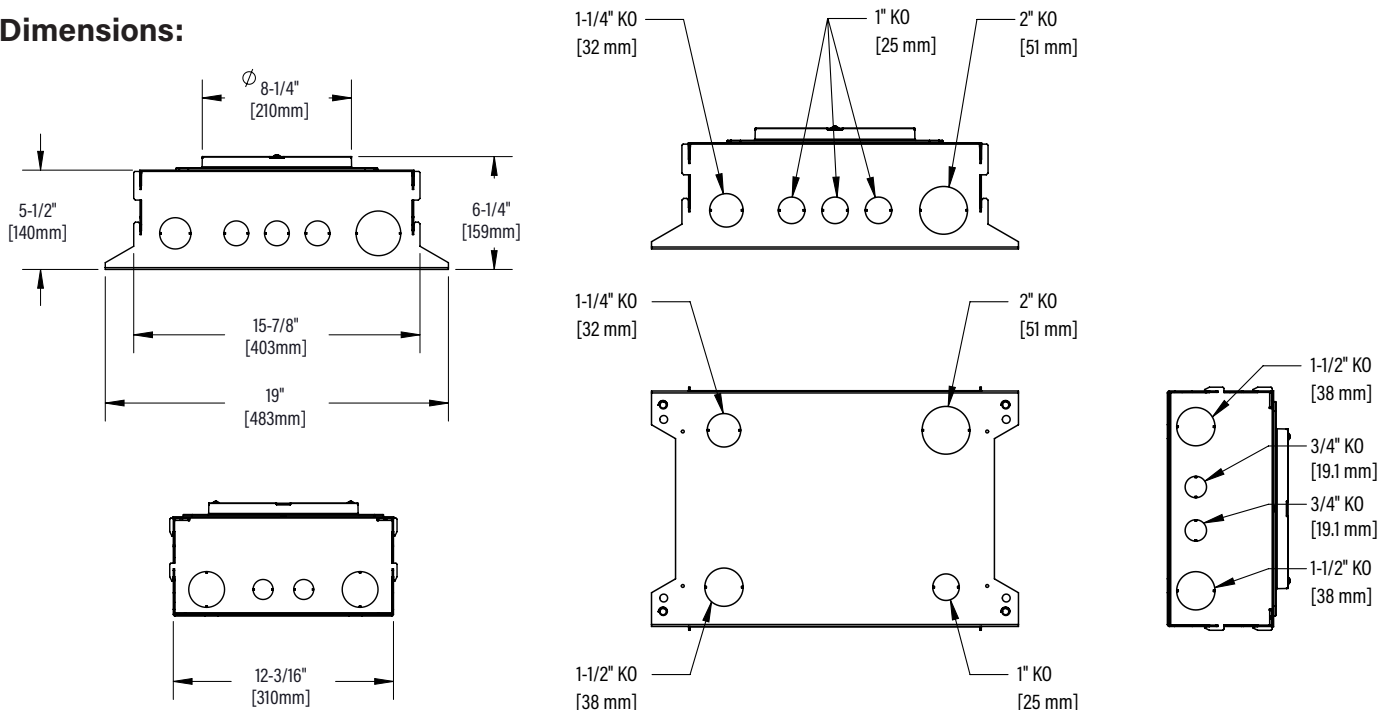

RFBA Series Round Activation Floor Boxes Accessories Ordering Information

RFBAB

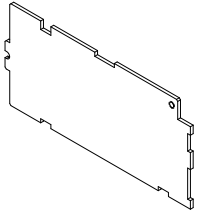

Blank Device Plate - Closes off unused gangs.

RFBAS2

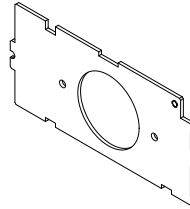

1.59" Single Device Plate - Receptacle opening 1 9/16" (40mm)

RFBADP

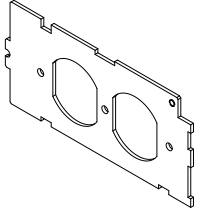

Duplex Device Plate - Accepts standard 15 Amp & 20 Amp Duplex Receptacles.

RFBA6A

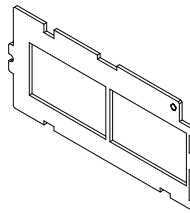

Communications Plate - Accepts bezels for common communications devices. Including TracJack, Series II, Keystone, Lucent

RFBADP20TR

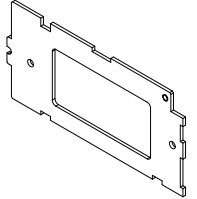

Decorator Device Plate - Accepts Decorator Style Receptacles, Communication or A/V Devices.

RFBA6AAP

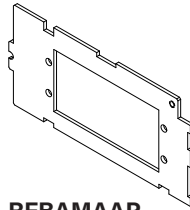

AAP Device Plate - Accepts Extron® Electronics AAP devices (sold separately)

RFBADEC

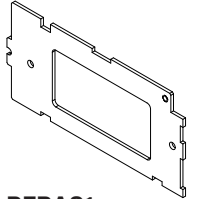

Decorator Device Plate - Accepts Decorator Style Receptacles, Communication or A/V Devices.

RFBAMAAP

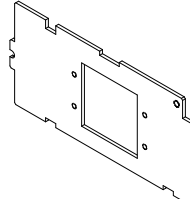

MAAP Device Plate - Accepts two (2) Legrand AVIP or Extron® Electronics MAAP Series Devices (sold separately)

RFBAS1

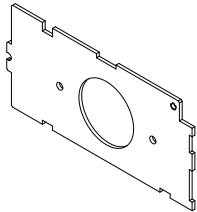

1.39" Single Device Plate - Receptacle opening 1 3/8" (35mm)

RFBA610C4EXT

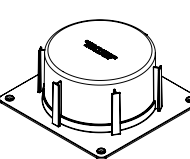

4" Round Extension Ring for 6/10-gang Floor Boxes - Used to extend height of floor box. Cut to desired level after concrete pour.

RFBA24C4EXT

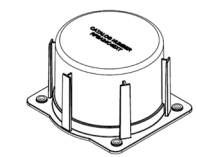

4" Round Extension Ring for 2/4-gang Floor Boxes - Used to extend height of floor box. Cut to desired level after concrete pour.

RFBAC24FF

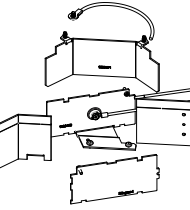

Furniture Feed Barrier Kit for 2 and 4-Gang Boxes - Used to separate power and communication services. Used in combination with 6" Evolution Series Furniture Feed Covers (6CFFTC). Covers sold separately

2HUB

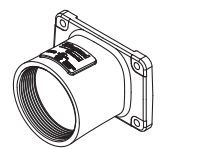

2" Conduit Transition Hub - Trade size 2" die cast zinc conduit fitting allows for 2" conduit to transition into a shallow box design. Includes: die cast fitting, gasket, and mounting screws.

RFBADJ4LB

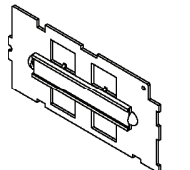

Device Mounting Plate - Accepts 4 jacks of data and includes removable label holder and labels

RFBA10-2G

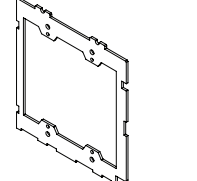

2-Gang Adapter Plate for 10-Gang Box

RFBA10-3G

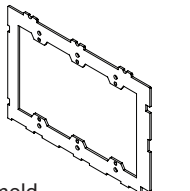

3-Gang Adapter Plate for 10-Gang Box

Evolution Series 6" Cover Assemblies Ordering Information - Use with 2 and 4-Gang RFBAC

Catalog No./Item	Description/Specifications	Catalog No./Item	Description/Specifications
<p>Powder Coat Finishes 6CTC2BK 6CTC2GY 6CTC2BZ</p> <p>Durable Finishes 6CTC2AA* 6CTC2SB* 6CTC2SN*</p> <p>*NOTE: Durable finishes are available as BAA product with -NA suffix.</p>	<p>Surface Style Cover Assembly - Low profile cover designed to attach to the 2 and 4-gang RFBA round activation floor boxes. Each cover is made from die-cast aluminum materials and equipped with a durable hinge which allows the cover to rotate open 180°, two (2) slide egress doors that lock in the open position and auto-close around the cables when the covers are closed, and an 8° beveled edge that meets ADA guidelines and reduces tripping hazards. These covers are designed to sit on top of finished floor surfaces such as: carpet, tile, wood, polished concrete, and terrazzo. Available in three (3) aesthetic powder coated finishes: black (BK), gray (GY), bronze (BZ) and three durable finishes: brushed aluminum (AA), satin brass plated (SB), and satin nickel plated (SN).</p>	<p>Powder Coat Finishes 6CTC2BKTR 6CTC2GYTR 6CTC2BZTR</p> <p>Durable Finishes 6CTC2AATR* 6CTC2SBTR* 6CTC2SNTR*</p> <p>*NOTE: Durable finishes are available as BAA product with -NA suffix.</p>	<p>Tamper-Resistant Surface Style Cover Assembly - Low profile cover designed to attach to the 2 and 4-gang RFBA round activation floor boxes. Each cover is made from die-cast aluminum materials and equipped with a durable hinge which allows the cover to rotate open 180°, two (2) slide egress doors that lock in the open position and auto-close around the cables when the covers are closed, and an 8° beveled edge that meets ADA guidelines and reduces tripping hazards. These covers are designed to sit on top of finished floor surfaces such as: carpet, tile, wood, polished concrete, and terrazzo. Available in three (3) aesthetic powder coated finishes: black (BK), gray (GY), bronze (BZ) and three durable finishes: brushed aluminum (AA), satin brass plated (SB), and satin nickel plated (SN).</p>

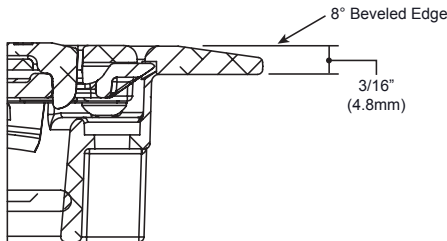
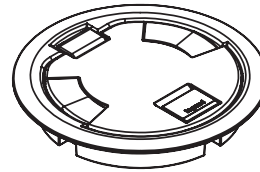
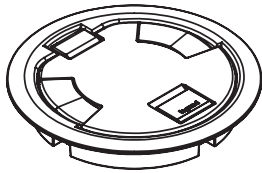

<p>Powder Coat Finishes 6CFFTCBK 6CFFTCGY 6CFFTCBZ</p> <p>Durable Finishes 6CFFTCAA 6CFFTCSB 6CFFTCSN</p>	<p>Furniture Feed Cover Assembly - Surface style, die-cast aluminum cover assembly, with one (1) 3/4" trade size screw plug opening, and one (1) concentric 2"-1 1/4" trade size screw plug opening and one (1) divider to separate services. Cover assembly is available in three (3) powder coated finishes: black (BK), gray(GY), bronze (BZ) and also available in three (3) durable finishes: brushed aluminum (AA), satin brass plated (SB) and satin nickel plated (SN). 6CFFTC Series Cover Assemblies designed for use 2 and 4-gang RFBA round activation floor boxes.</p>
---	--

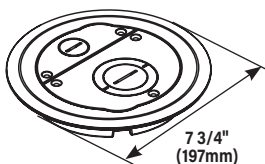

Evolution Series 6" Cover Assemblies Ordering Information - Use with 2 and 4-Gang RFBAC

Catalog No./Item	Description/Specifications	Catalog No./Item	Description/Specifications
6CT-CTR	6" Terrazzo Ring - Nonmetallic ring for use on terrazzo floor applications. Compatible with the 2 and 4-gang RFBA round activation floor boxes.	6TS	Tile Shim - Used for floor coverings greater than 3/16" (4.8mm). The 6TS will allow the top surface of the cover to be flush with the finished floor. Includes: six (6) 1/16" (1.6mm) thick sjims. Up to a total of 3/8" (9.5mm) of adjustment.

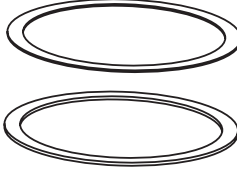
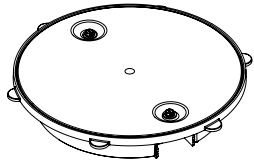

Catalog No./Item	Description/Specifications	Catalog No./Item	Description/Specifications
Powder Coat Finishes 6CT2BK 6CT2GY 6CT2BZ Durable Finishes 6CT2AA* 6CT2SB* 6CT2SN*	Flush Style Cover Assembly - Low profile cover designed to attach to the 2 and 4-gang RFBA round activation floor boxes. Each cover is made from die-cast aluminum materials and equipped with a durable hinge which allows the cover to rotate open 180°, two (2) slide egress doors that lock in the open position and auto-close around the cables when the covers are closed. These covers are designed to sit flush with finished floor covers such as: carpet, tile, and wood. Available in three (3) aesthetic powder coated finishes: black (BK), gray (GY), bronze (BZ) and three durable finishes: brushed aluminum (AA), satin brass plated (SB), and satin nickel plated (SN).	Powder Coat Finishes 6CT2BKTR 6CT2GYTR 6CT2BZTR Durable Finishes 6CT2AATR* 6CT2SBTR* 6CT2SNTR*	Tamper-Resistant Flush Style Cover Assembly - Low profile cover designed to attach to the 2 and 4-gang RFBA round activation floor boxes. Each cover is made from die-cast aluminum materials and equipped with a tamper-resistant screw to keep out unauthorized personnel, a durable hinge which allows the cover to rotate open 180°, two (2) slide egress doors that lock in the open position and auto-close around the cables when the covers are closed. These covers are designed to sit flush with finished floor surfaces such as: carpet, tile, wood, polished concrete, and terrazzo. Available in three (3) aesthetic powder coated finishes: black (BK), gray (GY), bronze (BZ) and three durable finishes: brushed aluminum (AA), satin brass plated (SB), and satin nickel plated (SN).

***NOTE:** Durable finishes are available as BAA product with -NA suffix.

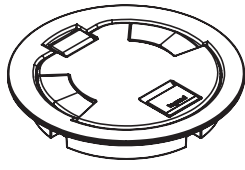

***NOTE:** Durable finishes are available as BAA product with -NA suffix.

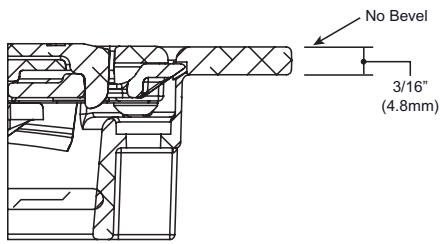
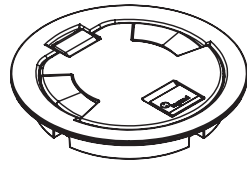

NOTE: INCLUDED 6TS TILE SHIM

NOTE: Pricing varies depending on country of origin. Consult your local sales representative for more information.

Evolution Series 8" Cover Assemblies Ordering Information - Use with 6 and 10-Gangs RFBAC

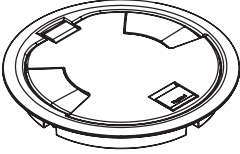
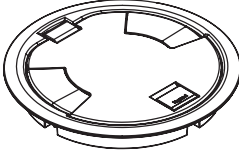
Catalog No./Item	Description/Specifications	Catalog No./Item	Description/Specifications
<p>Powder Coat Finishes 8CTC2BK 8CTC2GY 8CTC2BZ</p> <p>Durable Finishes 8CTC2AA* 8CTC2SB* 8CTC2SN*</p> <p>*NOTE: Durable finishes are available as BAA product with -NA suffix.</p> 	<p>Surface Style Cover Assembly - Low profile cover designed to attach to the 6 and 10-gang RFBA round activation floor boxes. Each cover is made from die-cast aluminum materials and equipped with a durable hinge which allows the cover to rotate open 180°, two (2) slide egress doors that lock in the open position and auto-close around the cables when the covers are closed, and an 8° beveled edge that meets ADA guidelines and reduces tripping hazards. These covers are designed to sit on top of finished floor surfaces such as: carpet, tile, wood, polished concrete, and terrazzo. Available in three (3) aesthetic powder coated finishes: black (BK), gray (GY), bronze (BZ) and three durable finishes: brushed aluminum (AA), satin brass plated (SB), and satin nickel plated (SN).</p>	<p>Powder Coat Finishes 8CTC2BKTR 8CTC2GYTR 8CTC2BZTR</p> <p>Durable Finishes 8CTC2AATR* 8CTC2SBTR* 8CTC2SNTR*</p> <p>*NOTE: Durable finishes are available as BAA product with -NA suffix.</p> 	<p>Tamper-Resistant Surface Style Cover Assembly - Low profile cover designed to attach to the 6 and 10-gang RFBA round activation floor boxes. Each cover is made from die-cast aluminum materials and equipped with a durable hinge which allows the cover to rotate open 180°, two (2) slide egress doors that lock in the open position and auto-close around the cables when the covers are closed, and an 8° beveled edge that meets ADA guidelines and reduces tripping hazards. These covers are designed to sit on top of finished floor surfaces such as: carpet, tile, wood, polished concrete, and terrazzo. Available in three (3) aesthetic powder coated finishes: black (BK), gray (GY), bronze (BZ) and three durable finishes: brushed aluminum (AA), satin brass plated (SB), and satin nickel plated (SN).</p>

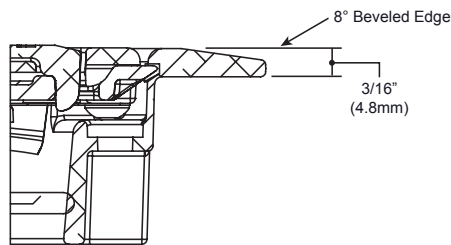

Evolution Series 8" Cover Assemblies Ordering Information - Use with 6 and 10-Gang RFBAC

Catalog No./Item	Description/Specifications	Catalog No./Item	Description/Specifications
8CT-CTR	8" Terrazzo Ring - Nonmetallic ring for use on terrazzo floor applications. Compatible with the 6 and 10-gang RFBA round activation floor boxes.	8TS	Tile Shim - Used for floor coverings greater than 3/16" (4.8mm). The 8TS will allow the top surface of the cover to be flush with the finished floor. Includes: six (6) 1/16" (1.6mm) thick sjims. Up to a total of 3/8" (9.5mm) of adjustment.
Powder Coat Finishes 8CT2BK 8CT2GY 8CT2BZ	Flush Style Cover Assembly - Low profile cover designed to attach to the 6 and 10-gang RFBA round activation floor boxes. Each cover is made from die-cast aluminum materials and equipped with a durable hinge which allows the cover to rotate open 180°, two (2) slide egress doors that lock in the open position and auto-close around the cables when the covers are closed. These covers are designed to sit flush with finished floor covers such as: carpet, tile, and wood. Available in three (3) aesthetic powder coated finishes: black (BK), gray (GY), bronze (BZ) and three durable finishes: brushed aluminum (AA), satin brass plated (SB), and satin nickel plated (SN).	Powder Coat Finishes 8CT2BKTR 8CT2GYTR 8CT2BZTR	Tamper-Resistant Flush Style Cover Assembly - Low profile cover designed to attach to the 6 and 10-gang RFBA round activation floor boxes. Each cover is made from die-cast aluminum materials and equipped with a tamper-resistant screw to keep out unauthorized personnel, a durable hinge which allows the cover to rotate open 180°, two (2) slide egress doors that lock in the open position and auto-close around the cables when the covers are closed. These covers are designed to sit flush with finished floor surfaces such as: carpet, tile, wood, polished concrete, and terrazzo. Available in three (3) aesthetic powder coated finishes: black (BK), gray (GY), bronze (BZ) and three durable finishes: brushed aluminum (AA), satin brass plated (SB), and satin nickel plated (SN).
Durable Finishes 8CT2AA* 8CT2SB* 8CT2SN*		Durable Finishes 8CT2AATR* 8CT2SBTR* 8CT2SNTR*	
*NOTE: Durable finishes are available as BAA product with -NA suffix.		*NOTE: Durable finishes are available as BAA product with -NA suffix.	

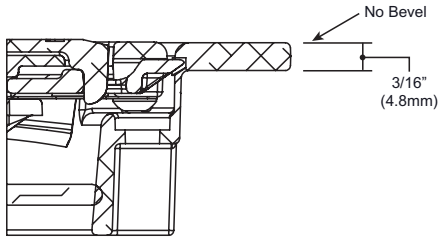

NOTE: INCLUDED 8TS TILE SHIM

NOTE: All brand and product names referenced in this document are registered trademarks or trademarks of their respective holders.



Recessed Floor Boxes for Concrete

RFBA2C, RFBA4C, RFBA6C, RFBA10C

RFBA Series of Floor Boxes with round activations are versatile recessed activation solutions that provide power, communication and/or audio/video services to open space areas, or directly to workstations. The floor boxes come in various sizes and depths, including 2, 4, 6 and 10-gangs to best fit your specific application. The round activation boxes utilize existing Evolution™ series round covers and are designed to sit on top or flush with finished floor surfaces, such as carpet, tile, wood flooring, polished concrete or terrazzo. The RFBA series includes improved wire and cable routing, allowing for easier wire pulling in adjacent compartments and around corners.

The RFBA floor box is built for multiple applications and environments

Features & Benefits

- **Suitable for Various Applications.** Steel and on-grade (epoxy coated) to meet your specific installation requirements with support for installation in carpet, wood flooring, tile, terrazzo and polished concrete.
- **Various Gang and Depth Options Available.** Choose from either 2, 4, 6 or 10-gang boxes to fit your application. The 2 and 4-gang options are available in either a shallow (3.25") depth or standard (3.75") depth box.
- **Common Mounting Plates.** All models share the same mounting plates, allowing for easier configuration and specification.
- **Numerous Conduit Knockouts.** Features knockouts on all sides and bottom of box to allow for greater installation flexibility to work within your environment.
- **Utilizes Evolution™ Series Round Covers.** Choose from a wide range of die-cast aluminum cover assemblies, available in powder coated finishes of black, gray and bronze, as well as durable finishes with brushed aluminum, satin brass plated and satin nickel plated.
- **Improved Cable Management.** Internal compartments feature improved wire and cable routing for easier wire pulling in adjacent compartments and around corners.
- **Post-Pour Features:** Allows for adjustment post-pour and features removable dividers that can be installed or removed before or after the concrete pour.

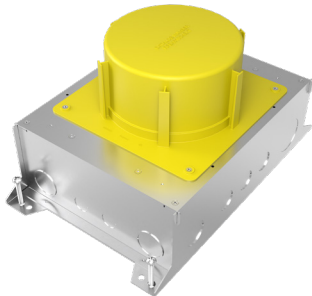

Round extension ring can be used to extend height of box up to 4 inches

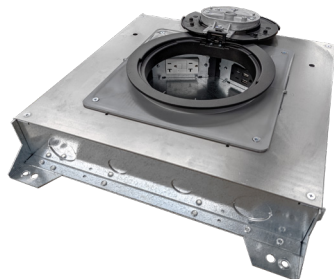

All models share eight (8) common device plates, allowing for data and power within the same box



Compatible with existing Evolution Series die-cast aluminum covers. Choose from powder coated finishes or durable finishes.

Compliance



cULus Listed: Metallic Outlet Boxes for tile, terrazzo, carpet and wood floors.
File E2961 Guide QCIT

RFBA Series Round Activation Floor Boxes Ordering Information

Box Model	Box Type	Box Capacity	Box Depth	Conduit Size	Cover Style
RFBA2C25	Above Grade	2-Gang	3.25"	¾" - 1 ¼"	Evolution 6" Round Covers
RFBA2C25OG	On-Grade	2-Gang	3.25"	¾" - 1 ¼"	Evolution 6" Round Covers
RFBA2C30	Above Grade	2-Gang	3.75"	¾" - 2"*	Evolution 6" Round Covers
RFBA2C30OG	On-Grade	2-Gang	3.75"	¾" - 2"*	Evolution 6" Round Covers
RFBA4C25	Above Grade	4-Gang	3.25"	¾" - 1 ½"	Evolution 6" Round Covers
RFBA4C25OG	On-Grade	4-Gang	3.25"	¾" - 1 ½"	Evolution 6" Round Covers
RFBA4C30	Above Grade	4-Gang	3.75"	¾" - 2"*	Evolution 6" Round Covers
RFBA4C30OG	On-Grade	4-Gang	3.75"	¾" - 2"*	Evolution 6" Round Covers
RFBA6C30	Above Grade	6-Gang	3.75"	¾" - 2"*	Evolution 8" Round Covers
RFBA6C30OG	On-Grade	6-Gang	3.75"	¾" - 2"*	Evolution 8" Round Covers
RFBA10C55	Above Grade	10-Gang	6.25"	¾" - 2"	Evolution 8" Round Covers
RFBA10C55OG	On-Grade	10-Gang	6.25"	¾" - 2"	Evolution 8" Round Covers

* Additional 2HUB accessory is needed on the 2, 4 and 6-gang boxes if using a 2" conduit feed to the box. Largest knockout without the 2HUB accessory on the 2, 4 and 6-gang boxes is 1 ¼".

RFBA Series Round Activation Floor Boxes Ordering Information

RFBA2C25

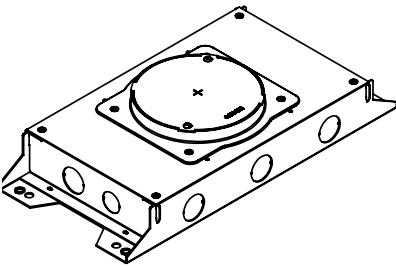

RFBA 2-Gang Round Floor Box, Shallow 3.25" Depth – Steel floor box designed for above grade installations. Features 2-gangs of box capacity with at least 3 ⅛" available behind device plates. Fully adjustable before and after concrete pour. Designed for carpet, wood flooring, tile, terrazzo and polished concrete and applications. Use with Evolution™ Series 6" round covers. When ordering device plates for box, 2 blank device plates (Cat. No. RFBAB) must also be ordered to seal of wire and cable routing passageways.

Concrete Pour: Minimum concrete pour is 3.25"

Sold Separately:

- Evolution™ Series 6CTC & 6CT Round Covers
- Device Plates

RFBA2C25OG

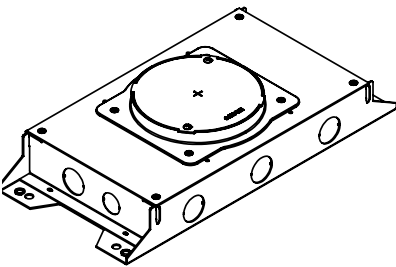

RFBA 2-Gang On-Grade Round Floor Box, Shallow 3.25" Depth – Steel floor box designed for on-grade installations with a fusion-bonded epoxy for use on metal reinforcement bar and related accessories before encapsulating in concrete. Features 2-gangs of box capacity with at least 3 ⅛" available behind device plates. Fully adjustable before and after concrete pour. Designed for carpet, wood flooring, tile, terrazzo and polished concrete applications. Use with Evolution™ Series 6" round covers. When ordering device plates for box, 2 blank device plates (Cat. No. RFBAB) must also be ordered to seal of wire and cable routing passageways.

Concrete Pour: Minimum concrete pour is 3.25"

Sold Separately:

- Evolution™ Series 6CTC & 6CT Round Covers
- Device Plates

Dimensions:

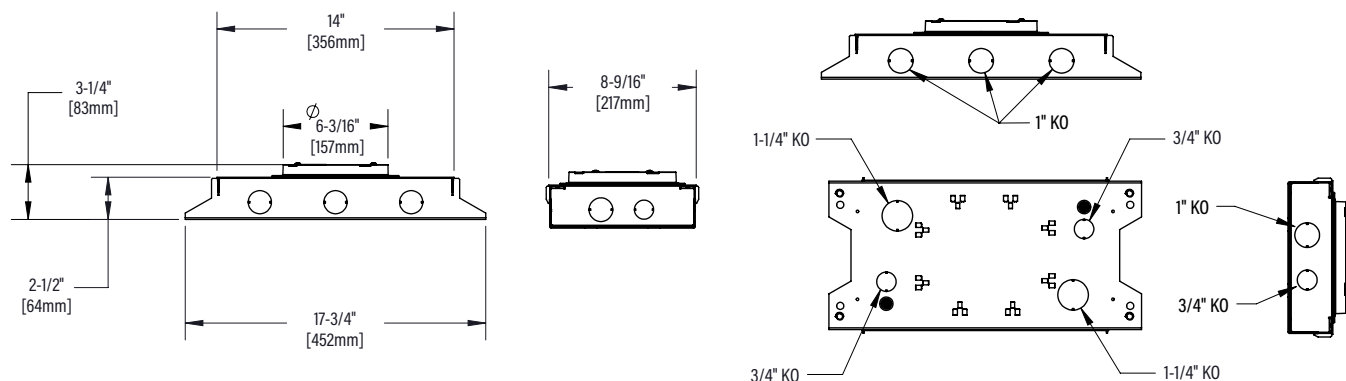

RFBA Series Round Activation Floor Boxes Ordering Information

RFBA2C30

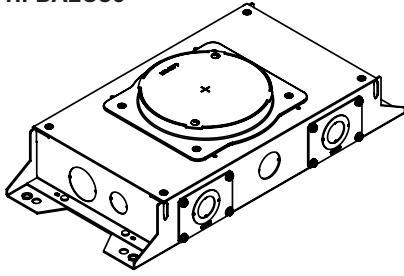

RFBA 2-Gang Round Floor Box, Standard 3.75" Depth – Steel floor box designed for above grade installations. Features 2-gangs of box capacity with at least 3 1/16" available behind device plates. Fully adjustable before and after concrete pour. Designed for carpet, wood flooring, tile, terrazzo and polished concrete applications. Use with Evolution™ Series 6" round covers. When ordering device plates for box, 2 blank device plates (Cat. No. RFBAB) must also be ordered to seal of wire and cable routing passageways.

Concrete Pour: Minimum concrete pour is 3.75"

Sold Separately:

- Evolution™ Series 6CTC & 6CT Round Covers
- Device Plates

RFBA2C30OG RFBA2C30OG-NA*

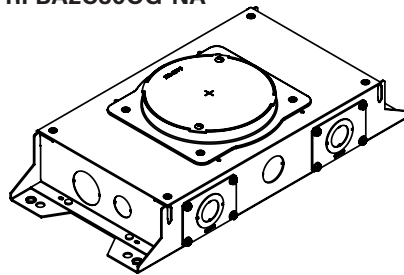

RFBA 2-Gang On-Grade Round Floor Box, Standard 3.75" Depth – Steel floor box designed for on-grade installations with a fusion-bonded epoxy for use on metal reinforcement bar and related accessories before encapsulating in concrete. Features 2-gangs of box capacity with at least 3 1/16" available behind device plates. Fully adjustable before and after concrete pour. Designed for carpet, wood flooring, tile, terrazzo and polished concrete applications. Use with Evolution™ Series 6" round covers. When ordering device plates for box, 2 blank device plates (Cat. No. RFBAB) must also be ordered to seal of wire and cable routing passageways.

Concrete Pour: Minimum concrete pour is 3.75"

Sold Separately:

- Evolution™ Series 6CTC & 6CT Round Covers
- Device Plates

*OG version available as BAA compliant product by adding -NA

Dimensions:

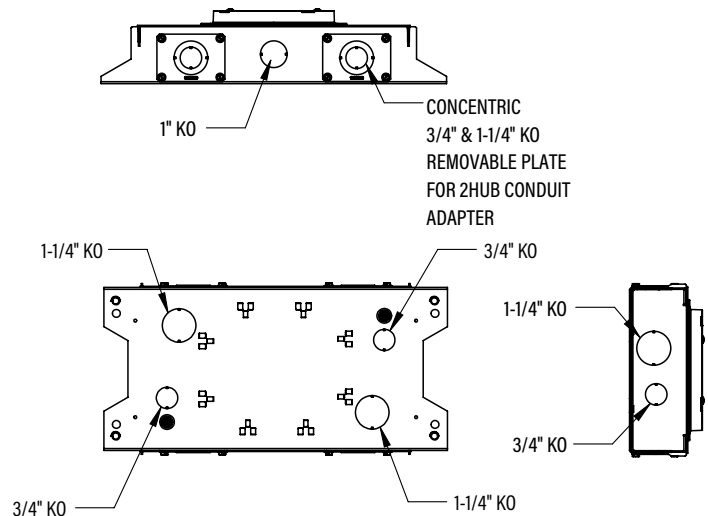
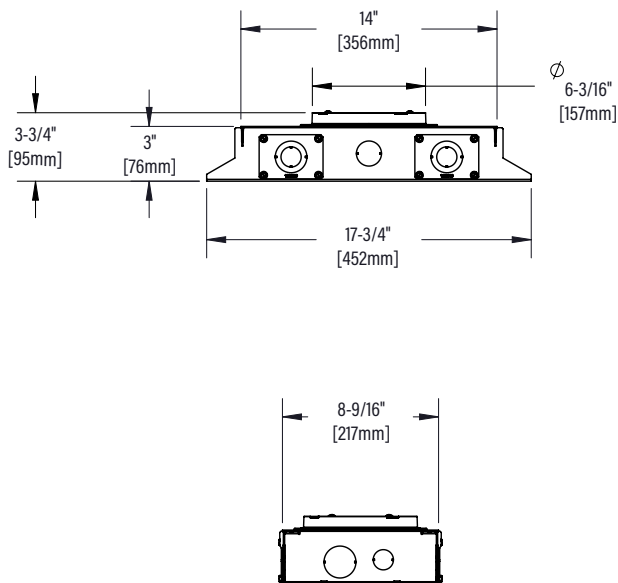

RFBA Series Round Activation Floor Boxes Ordering Information

RFBA4C25

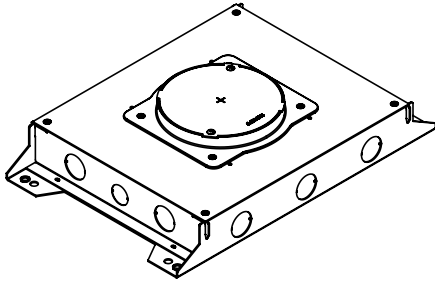

RFBA 4-Gang Round Floor Box, Shallow 3.25" Depth - Steel floor box designed for above grade installations. Features 4-gangs of box capacity with at least 2 9/16" available behind device plates. Fully adjustable before and after concrete pour. Designed for carpet, wood flooring, tile, terrazzo and polished concrete applications. Use with Evolution™ Series 6" round covers.

Concrete Pour: Minimum concrete pour is 3.25"

Sold Separately:

- Evolution™ Series 6CTC & 6CT Round Covers
- Device Plates

RFBA4C25OG

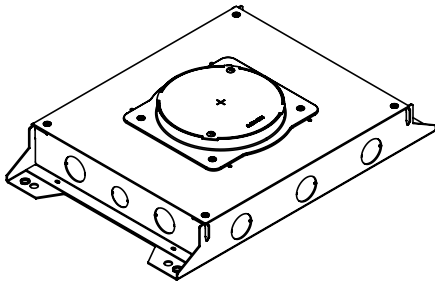

RFBA 4-Gang On-Grade Round Floor Box, Shallow 3.25" Depth - Steel floor box designed for on-grade installations with a fusion-bonded epoxy for use on metal reinforcement bar and related accessories before encapsulating in concrete. Features 4-gangs of box capacity with at least 2 9/16" available behind device plates. Fully adjustable before and after concrete pour. Designed for carpet, wood flooring, tile, terrazzo and polished concrete applications. Use with Evolution™ Series 6" round covers.

Concrete Pour: Minimum concrete pour is 3.25"

Sold Separately:

- Evolution™ Series 6CTC & 6CT Round Covers
- Device Plates

Dimensions:

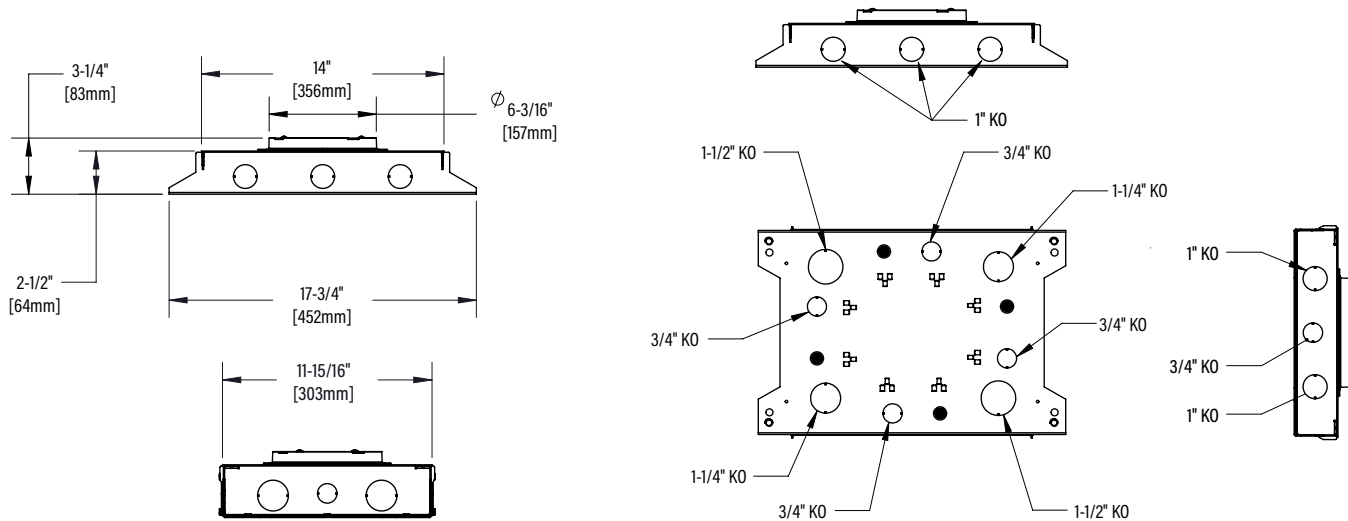

RFBA Series Round Activations Floor Boxes Ordering Information

RFBA4C30

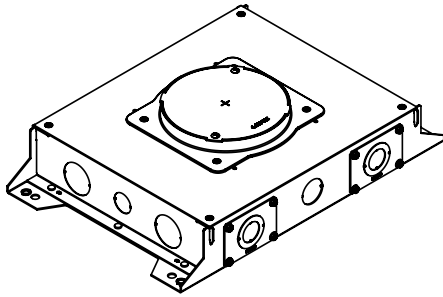

RFBA 4-Gang Round Floor Box, Standard 3.75" Depth - Steel floor box designed for above grade installations. Features 4-gangs of box capacity with at least 2 9/16" available behind device plates. Fully adjustable before and after concrete pour. Designed for carpet, wood flooring, tile, terrazzo and polished concrete applications. Use with Evolution™ Series 6" round covers.

Concrete Pour: Minimum concrete pour is 3.75"

Sold Separately:

- Evolution™ Series 6CTC & 6CT Round Covers
- Device Plates

RFBA4C30OG RFBA4C30OG-NA*

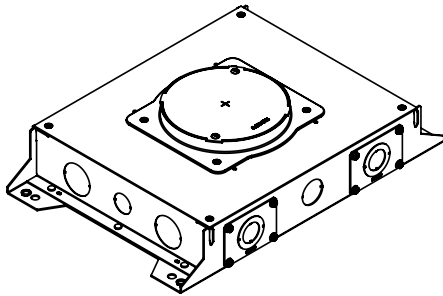

RFBA 4-Gang On-Grade Round Floor Box, Standard 3.75" Depth - Steel floor box designed for on-grade installations with a fusion-bonded epoxy for use on metal reinforcement bar and related accessories before encapsulating in concrete. Features 4-gangs of box capacity with at least 2 9/16" available behind device plates. Fully adjustable before and after concrete pour. Designed for carpet, wood flooring, tile, terrazzo and polished concrete applications. Use with Evolution™ Series 6" round covers.

Concrete Pour: Minimum concrete pour is 3.75"

Sold Separately:

- Evolution™ Series 6CTC & 6CT Round Covers
- Device Plates

*OG version available as BAA compliant product by adding -NA

Dimensions:

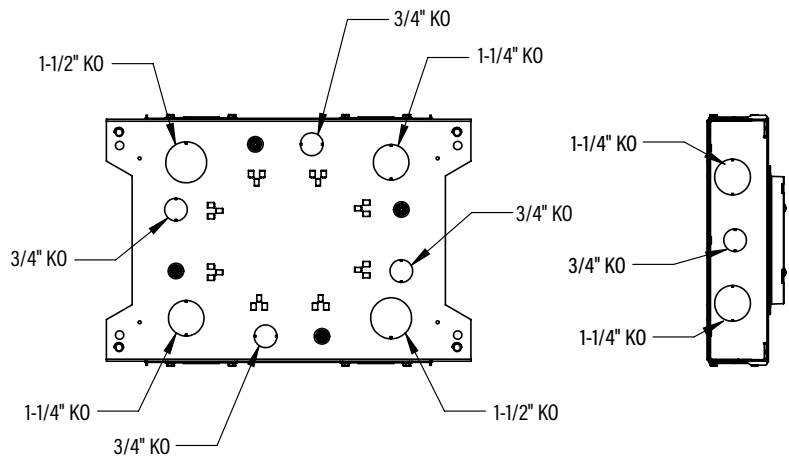
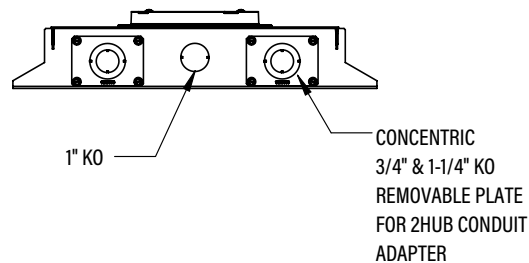
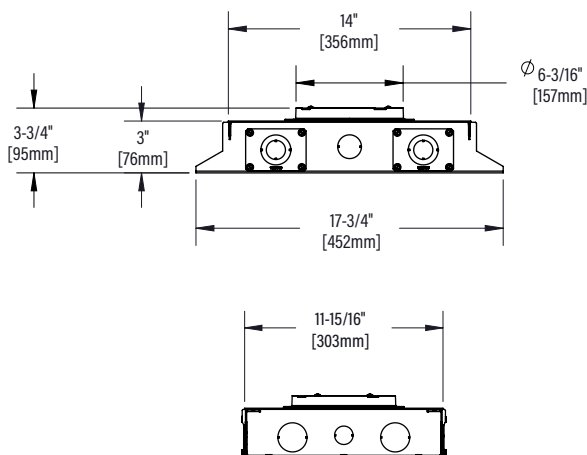

RFBA Series Round Activation Floor Boxes Ordering Information

RFBA6C30

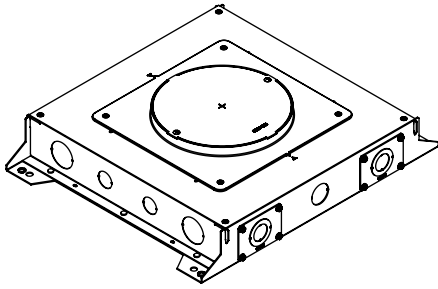

RFBA 6-Gang Round Floor Box, Standard 3.75" Depth - Steel floor box designed for above grade installations. Features 6-gangs of box capacity with at least 2 9/16" available behind device plates. Fully adjustable before and after concrete pour. Designed for carpet, wood flooring, tile, terrazzo and polished concrete applications. Use with Evolution™ Series 8" round covers.

Concrete Pour: Minimum concrete pour is 3.75"

Sold Separately:

- Evolution™ Series 8CTC & 8CT Round Covers
- Device Plates

RFBA6C30OG
RFBA6C30OG-NA*

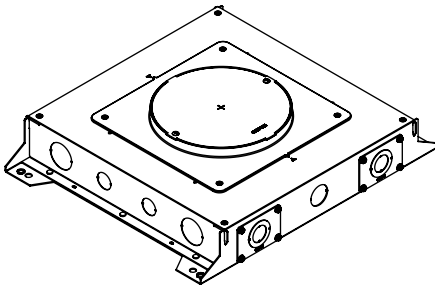

RFBA 6-Gang Round On-Grade Floor Box, Standard 3.75" Depth - Steel floor box designed for on-grade installations with a fusion-bonded epoxy for use on metal reinforcement bar and related accessories before encapsulating in concrete. Features 6-gangs of box capacity with at least 2 9/16" available behind device plates. Fully adjustable before and after concrete pour. Designed for carpet, wood flooring, tile, terrazzo and polished concrete applications. Use with Evolution™ Series 8" round covers.

Concrete Pour: Minimum concrete pour is 3.75"

Sold Separately:

- Evolution™ Series 8CTC & 8CT Round Covers
- Device Plates

*OG version available as BAA compliant product by adding -NA

Dimensions:

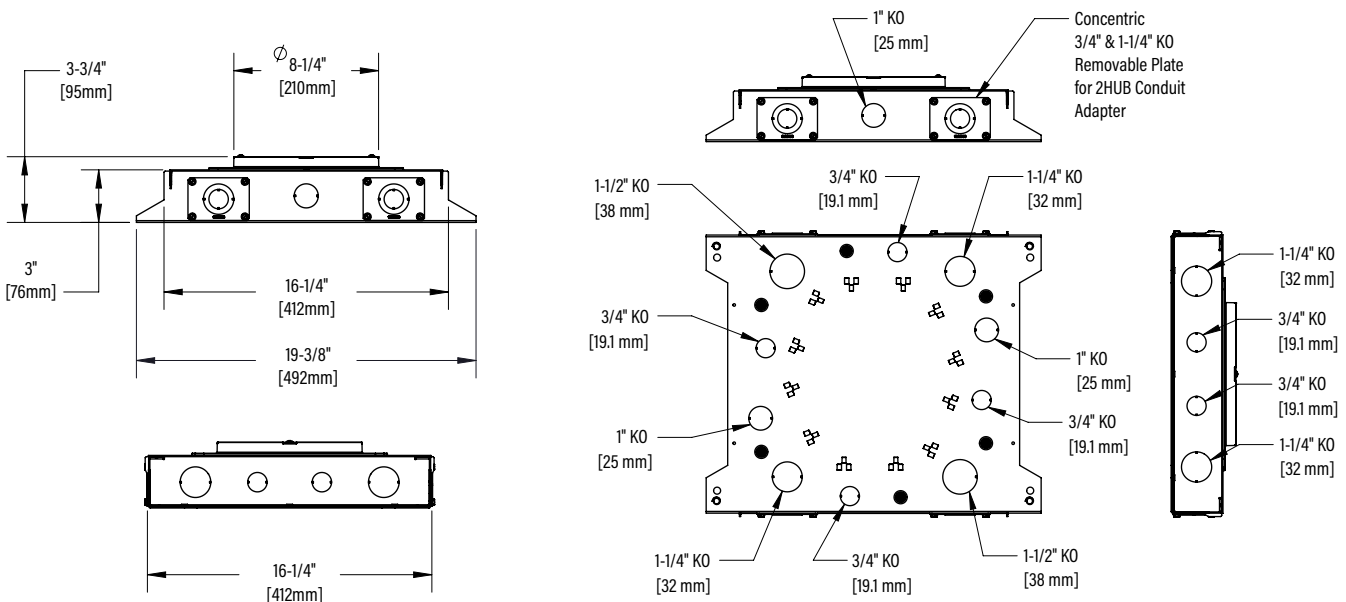

RFBA Series Round Activation Floor Boxes Ordering Information

RFBA10C55

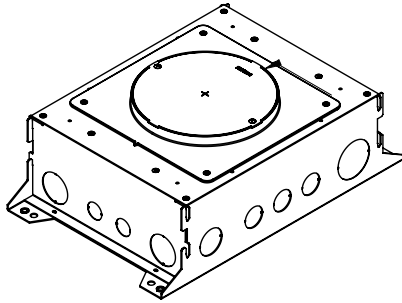

RFBA 10-Gang Round Floor Box, 6.25" Depth - Steel floor box designed for above grade installations. Features 10-gangs of box capacity with at least 2 1/2" available behind device plates. Fully adjustable before and after concrete pour. Designed for carpet, wood flooring, tile, terrazzo and polished concrete applications. Use with Evolution™ Series 8" round covers.

Sold Separately:

- Evolution™ Series 8CTC & 8CT Round Covers
- Device Plates

RFBA10C55OG RFBA10C55OG-NA*

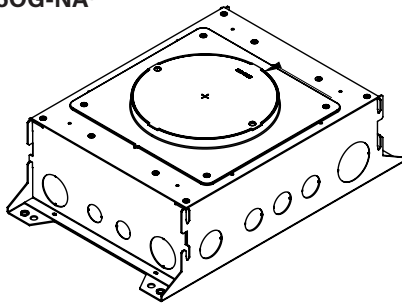

RFBA 10-Gang Round On-Grade Floor Box, 6.25" Depth - Steel floor box designed for on-grade installations with a fusion-bonded epoxy for use on metal reinforcement bar and related accessories before encapsulating in concrete. Features 10-gangs of box capacity with at least 2 1/2" available behind device plates. Fully adjustable before and after concrete pour. Designed for carpet, wood flooring, tile, terrazzo and polished concrete applications. Use with Evolution™ Series 8" round covers.

Concrete Pour: Minimum concrete pour is 6.25"

Sold Separately:

- Evolution™ Series 8CTC & 8CT Round Covers
- Device Plates

*OG version available as BAA compliant product by adding -NA

Dimensions:

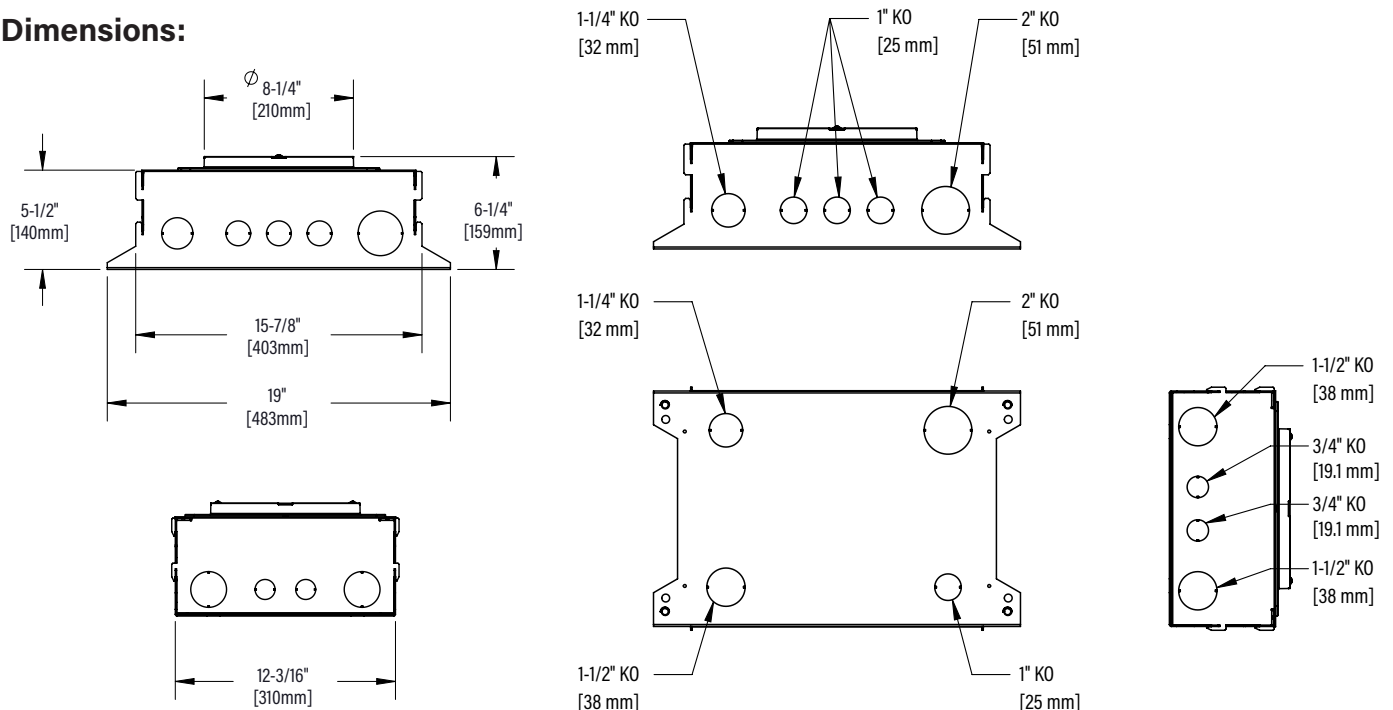

RFBA Series Round Activation Floor Boxes Accessories Ordering Information

RFBAB

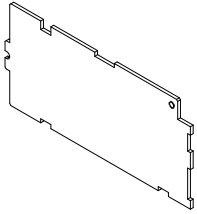

Blank Device Plate - Closes off unused gangs.

RFBAS2

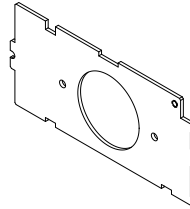

1.59" Single Device Plate - Receptacle opening 1 9/16" (40mm)

RFBADP

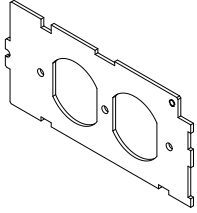

Duplex Device Plate - Accepts standard 15 Amp & 20 Amp Duplex Receptacles.

RFBA6A

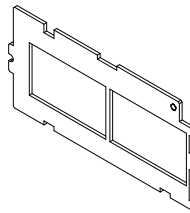

Communications Plate - Accepts bezels for common communications devices. Including TracJack, Series II, Keystone, Lucent

RFBADP20TR

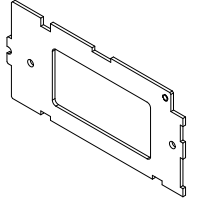

Decorator Device Plate - Accepts Decorator Style Receptacles, Communication or A/V Devices.

RFBAAAP

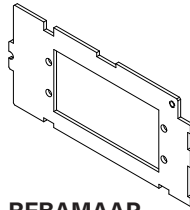

AAP Device Plate - Accepts Extron® Electronics AAP devices (sold separately)

RFBADEC

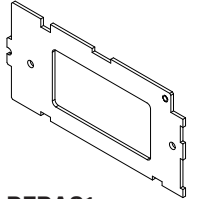

Decorator Device Plate - Accepts Decorator Style Receptacles, Communication or A/V Devices.

RFBAMAAP

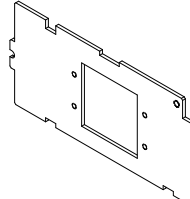

MAAP Device Plate - Accepts two (2) Legrand AVIP or Extron® Electronics MAAP Series Devices (sold separately)

RFBAS1

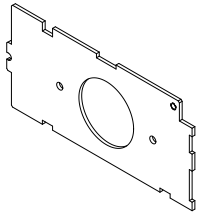

1.39" Single Device Plate - Receptacle opening 1 3/8" (35mm)

RFBA610C4EXT

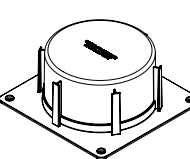

4" Round Extension Ring for 6/10-gang Floor Boxes - Used to extend height of floor box. Cut to desired level after concrete pour.

RFBA24C4EXT

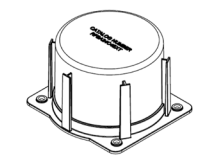

4" Round Extension Ring for 2/4-gang Floor Boxes - Used to extend height of floor box. Cut to desired level after concrete pour.

RFBAC24FF

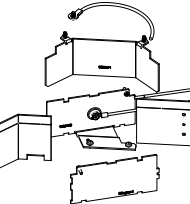

Furniture Feed Barrier Kit for 2 and 4-Gang Boxes - Used to separate power and communication services. Used in combination with 6" Evolution Series Furniture Feed Covers (6CFFTC). Covers sold separately

2HUB

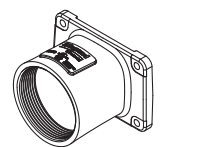

2" Conduit Transition Hub - Trade size 2" die cast zinc conduit fitting allows for 2" conduit to transition into a shallow box design. Includes: die cast fitting, gasket, and mounting screws.

RFBADJ4LB

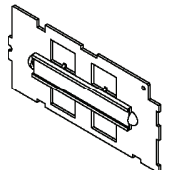

Device Mounting Plate - Accepts 4 jacks of data and includes removable label holder and labels

RFBA10-2G

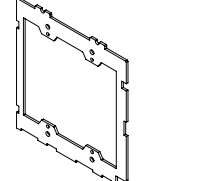

2-Gang Adapter Plate for 10-Gang Box

RFBA10-3G

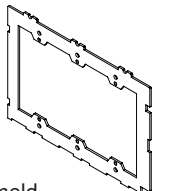

3-Gang Adapter Plate for 10-Gang Box

Evolution Series 6" Cover Assemblies Ordering Information - Use with 2 and 4-Gang RFBAC

Catalog No./Item	Description/Specifications	Catalog No./Item	Description/Specifications
<p>Powder Coat Finishes 6CTC2BK 6CTC2GY 6CTC2BZ</p> <p>Durable Finishes 6CTC2AA* 6CTC2SB* 6CTC2SN*</p> <p>*NOTE: Durable finishes are available as BAA product with -NA suffix.</p>	<p>Surface Style Cover Assembly - Low profile cover designed to attach to the 2 and 4-gang RFBA round activation floor boxes. Each cover is made from die-cast aluminum materials and equipped with a durable hinge which allows the cover to rotate open 180°, two (2) slide egress doors that lock in the open position and auto-close around the cables when the covers are closed, and an 8° beveled edge that meets ADA guidelines and reduces tripping hazards. These covers are designed to sit on top of finished floor surfaces such as: carpet, tile, wood, polished concrete, and terrazzo. Available in three (3) aesthetic powder coated finishes: black (BK), gray (GY), bronze (BZ) and three durable finishes: brushed aluminum (AA), satin brass plated (SB), and satin nickel plated (SN).</p>	<p>Powder Coat Finishes 6CTC2BKTR 6CTC2GYTR 6CTC2BZTR</p> <p>Durable Finishes 6CTC2AATR* 6CTC2SBTR* 6CTC2SNTR*</p> <p>*NOTE: Durable finishes are available as BAA product with -NA suffix.</p>	<p>Tamper-Resistant Surface Style Cover Assembly - Low profile cover designed to attach to the 2 and 4-gang RFBA round activation floor boxes. Each cover is made from die-cast aluminum materials and equipped with a durable hinge which allows the cover to rotate open 180°, two (2) slide egress doors that lock in the open position and auto-close around the cables when the covers are closed, and an 8° beveled edge that meets ADA guidelines and reduces tripping hazards. These covers are designed to sit on top of finished floor surfaces such as: carpet, tile, wood, polished concrete, and terrazzo. Available in three (3) aesthetic powder coated finishes: black (BK), gray (GY), bronze (BZ) and three durable finishes: brushed aluminum (AA), satin brass plated (SB), and satin nickel plated (SN).</p>

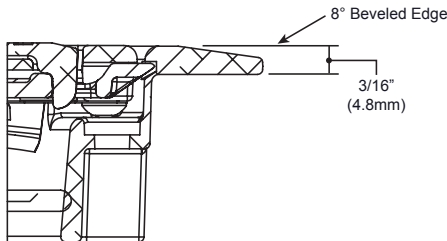
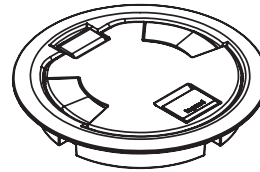
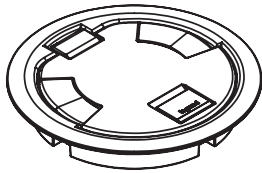

<p>Powder Coat Finishes 6CFFTCBK 6CFFTCGY 6CFFTCBZ</p> <p>Durable Finishes 6CFFTCAA 6CFFTCSB 6CFFTCSN</p>	<p>Furniture Feed Cover Assembly - Surface style, die-cast aluminum cover assembly, with one (1) 3/4" trade size screw plug opening, and one (1) concentric 2"-1 1/4" trade size screw plug opening and one (1) divider to separate services. Cover assembly is available in three (3) powder coated finishes: black (BK), gray(GY), bronze (BZ) and also available in three (3) durable finishes: brushed aluminum (AA), satin brass plated (SB) and satin nickel plated (SN). 6CFFTC Series Cover Assemblies designed for use 2 and 4-gang RFBA round activation floor boxes.</p>
---	--

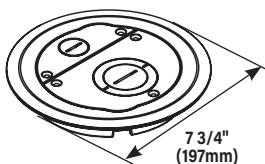

Evolution Series 6" Cover Assemblies Ordering Information - Use with 2 and 4-Gang RFBAC

Catalog No./Item	Description/Specifications	Catalog No./Item	Description/Specifications
6CT-CTR	6" Terrazzo Ring - Nonmetallic ring for use on terrazzo floor applications. Compatible with the 2 and 4-gang RFBA round activation floor boxes.	6TS	Tile Shim - Used for floor coverings greater than 3/16" (4.8mm). The 6TS will allow the top surface of the cover to be flush with the finished floor. Includes: six (6) 1/16" (1.6mm) thick shims. Up to a total of 3/8" (9.5mm) of adjustment.

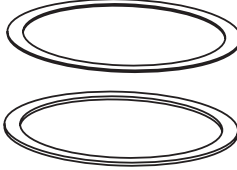
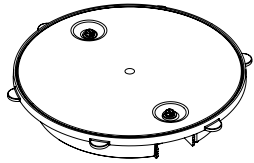

Catalog No./Item	Description/Specifications	Catalog No./Item	Description/Specifications
Powder Coat Finishes 6CT2BK 6CT2GY 6CT2BZ Durable Finishes 6CT2AA* 6CT2SB* 6CT2SN*	Flush Style Cover Assembly - Low profile cover designed to attach to the 2 and 4-gang RFBA round activation floor boxes. Each cover is made from die-cast aluminum materials and equipped with a durable hinge which allows the cover to rotate open 180°, two (2) slide egress doors that lock in the open position and auto-close around the cables when the covers are closed. These covers are designed to sit flush with finished floor covers such as: carpet, tile, and wood. Available in three (3) aesthetic powder coated finishes: black (BK), gray (GY), bronze (BZ) and three durable finishes: brushed aluminum (AA), satin brass plated (SB), and satin nickel plated (SN).	Powder Coat Finishes 6CT2BKTR 6CT2GYTR 6CT2BZTR Durable Finishes 6CT2AATR* 6CT2SBTR* 6CT2SNTR*	Tamper-Resistant Flush Style Cover Assembly - Low profile cover designed to attach to the 2 and 4-gang RFBA round activation floor boxes. Each cover is made from die-cast aluminum materials and equipped with a tamper-resistant screw to keep out unauthorized personnel, a durable hinge which allows the cover to rotate open 180°, two (2) slide egress doors that lock in the open position and auto-close around the cables when the covers are closed. These covers are designed to sit flush with finished floor surfaces such as: carpet, tile, wood, polished concrete, and terrazzo. Available in three (3) aesthetic powder coated finishes: black (BK), gray (GY), bronze (BZ) and three durable finishes: brushed aluminum (AA), satin brass plated (SB), and satin nickel plated (SN).

***NOTE:** Durable finishes are available as BAA product with -NA suffix.

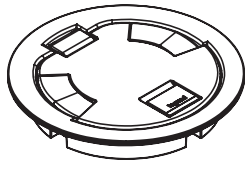

***NOTE:** Durable finishes are available as BAA product with -NA suffix.

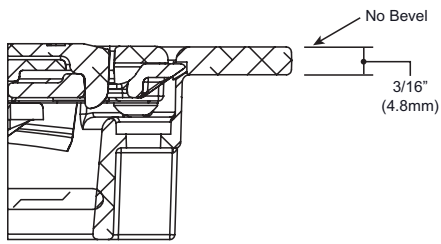
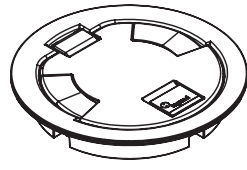

NOTE: INCLUDED 6TS TILE SHIM

NOTE: Pricing varies depending on country of origin. Consult your local sales representative for more information.

Evolution Series 8" Cover Assemblies Ordering Information - Use with 6 and 10-Gangs RFBAC

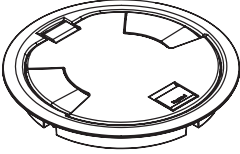
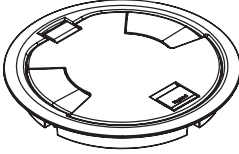
Catalog No./Item	Description/Specifications	Catalog No./Item	Description/Specifications
<p>Powder Coat Finishes 8CTC2BK 8CTC2GY 8CTC2BZ</p> <p>Durable Finishes 8CTC2AA* 8CTC2SB* 8CTC2SN*</p> <p>*NOTE: Durable finishes are available as BAA product with -NA suffix.</p> 	<p>Surface Style Cover Assembly - Low profile cover designed to attach to the 6 and 10-gang RFBA round activation floor boxes. Each cover is made from die-cast aluminum materials and equipped with a durable hinge which allows the cover to rotate open 180°, two (2) slide egress doors that lock in the open position and auto-close around the cables when the covers are closed, and an 8° beveled edge that meets ADA guidelines and reduces tripping hazards. These covers are designed to sit on top of finished floor surfaces such as: carpet, tile, wood, polished concrete, and terrazzo. Available in three (3) aesthetic powder coated finishes: black (BK), gray (GY), bronze (BZ) and three durable finishes: brushed aluminum (AA), satin brass plated (SB), and satin nickel plated (SN).</p>	<p>Powder Coat Finishes 8CTC2BKTR 8CTC2GYTR 8CTC2BZTR</p> <p>Durable Finishes 8CTC2AATR* 8CTC2SBTR* 8CTC2SNTR*</p> <p>*NOTE: Durable finishes are available as BAA product with -NA suffix.</p> 	<p>Tamper-Resistant Surface Style Cover Assembly - Low profile cover designed to attach to the 6 and 10-gang RFBA round activation floor boxes. Each cover is made from die-cast aluminum materials and equipped with a durable hinge which allows the cover to rotate open 180°, two (2) slide egress doors that lock in the open position and auto-close around the cables when the covers are closed, and an 8° beveled edge that meets ADA guidelines and reduces tripping hazards. These covers are designed to sit on top of finished floor surfaces such as: carpet, tile, wood, polished concrete, and terrazzo. Available in three (3) aesthetic powder coated finishes: black (BK), gray (GY), bronze (BZ) and three durable finishes: brushed aluminum (AA), satin brass plated (SB), and satin nickel plated (SN).</p>

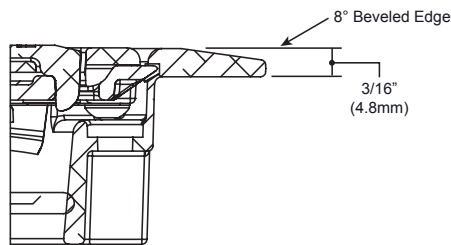

Evolution Series 8" Cover Assemblies Ordering Information - Use with 6 and 10-Gang RFBAC

Catalog No./Item	Description/Specifications	Catalog No./Item	Description/Specifications
8CT-CTR	8" Terrazzo Ring - Nonmetallic ring for use on terrazzo floor applications. Compatible with the 6 and 10-gang RFBA round activation floor boxes.	8TS	Tile Shim - Used for floor coverings greater than 3/16" (4.8mm). The 8TS will allow the top surface of the cover to be flush with the finished floor. Includes: six (6) 1/16" (1.6mm) thick sjims. Up to a total of 3/8" (9.5mm) of adjustment.
Powder Coat Finishes 8CT2BK 8CT2GY 8CT2BZ	Flush Style Cover Assembly - Low profile cover designed to attach to the 6 and 10-gang RFBA round activation floor boxes. Each cover is made from die-cast aluminum materials and equipped with a durable hinge which allows the cover to rotate open 180°, two (2) slide egress doors that lock in the open position and auto-close around the cables when the covers are closed. These covers are designed to sit flush with finished floor covers such as: carpet, tile, and wood. Available in three (3) aesthetic powder coated finishes: black (BK), gray (GY), bronze (BZ) and three durable finishes: brushed aluminum (AA), satin brass plated (SB), and satin nickel plated (SN).	Powder Coat Finishes 8CT2BKTR 8CT2GYTR 8CT2BZTR	Tamper-Resistant Flush Style Cover Assembly - Low profile cover designed to attach to the 6 and 10-gang RFBA round activation floor boxes. Each cover is made from die-cast aluminum materials and equipped with a tamper-resistant screw to keep out unauthorized personnel, a durable hinge which allows the cover to rotate open 180°, two (2) slide egress doors that lock in the open position and auto-close around the cables when the covers are closed. These covers are designed to sit flush with finished floor surfaces such as: carpet, tile, wood, polished concrete, and terrazzo. Available in three (3) aesthetic powder coated finishes: black (BK), gray (GY), bronze (BZ) and three durable finishes: brushed aluminum (AA), satin brass plated (SB), and satin nickel plated (SN).
Durable Finishes 8CT2AA* 8CT2SB* 8CT2SN*		Durable Finishes 8CT2AATR* 8CT2SBTR* 8CT2SNTR*	
*NOTE: Durable finishes are available as BAA product with -NA suffix.		*NOTE: Durable finishes are available as BAA product with -NA suffix.	

NOTE: INCLUDED 8TS TILE SHIM

NOTE: All brand and product names referenced in this document are registered trademarks or trademarks of their respective holders.