

Project		Catalog #		Type	
Prepared by		Notes		Date	



HALO

SMD6 Series

6" Round and Square Surface Mount Downlight
SMD6R & SMD6S

Typical Applications
Residential

Interactive Menu

- Order Information [page 2](#)
- Product Specifications [page 4](#)
- Photometric Data [page 5](#)
- Product Warranty

Product Certification



Refer to ENERGY STAR® Certified Products List.
Can be used to comply with California Title 24 High Efficacy requirements.
Certified to California Appliance Efficiency Database under JAB.

Product Features



Top Product Features

- Ultra-low profile surface luminaire with wide distribution
- Ceiling or wall mounting in compatible junction boxes
- 600 & 1200 lumen; 2700K, 3000K, 3500K, 4000K or 5000K field selectable CCT; 90 CRI
- 120V only and Universal Voltage 120V – 277V options
- Dimmable with 120V dimmers

Dimensional and Mounting Details

SMD6RXXXWH

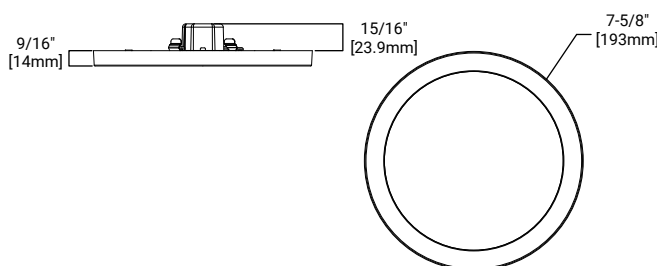

SMD6SXXXWH

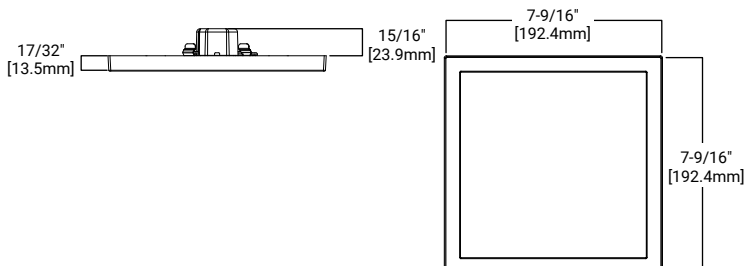

[additional product diagrams](#)

Dimensional and Mounting Details (continued)

SMD12RXXXWH
SMD12RXXXWHE

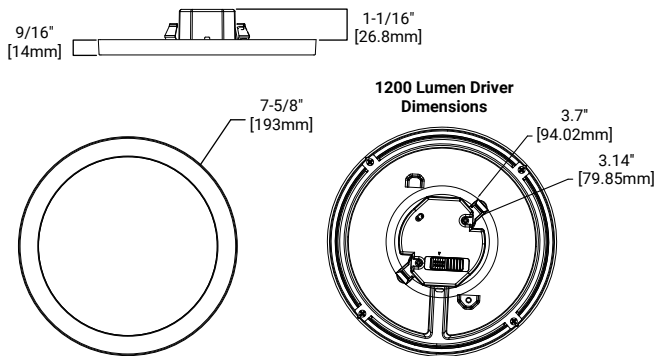

SMD12SXXXWH
SMD12SXXXWHE

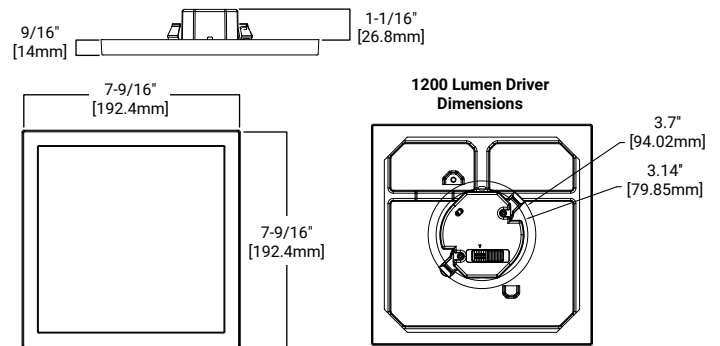

Note: Ensure junction box (provided by others) internal dimension supports driver dimension.

Ordering Information

SAMPLE NUMBER: **SMD6R69SWH** = 6" Round Surface Mount Downlight, 600 lumen, 90CRI, Selectable CCT, White, 120V

Junction Box Installation: Order junction box separately, as supplied by others, to complete installation.

Recessed Installation: Order HALO recessed housing and SMD6ACCKIT separately to complete installation.

Models	Lumens	CRI/CCT	Finish	Voltage
Models	Lumens	CRI/CCT	Finish	Voltage
SMD6R = 6" Round Surface Mount Downlight SMD6S = 6" Square Surface Mount Downlight	6 = 600 lumen series (120V only) 12 = 1200 lumen series ⁽¹⁾	9S = 90CRI, 2700K - 5000K Field Selectable CCT	WH = Matte White	Blank = 120V standard E = UNV Universal 120-277V ⁽²⁾
Notes	Notes	Notes	Notes	Notes
	(1) 1200 lumen series requires use of 4" square junction box or similar to support driver.			(2) UNV voltage configuration is offered only in the 1200 lumen series

Accessories

Accessories
<p>Designer Trims</p> <p>SMD6RTRMSN = 6" Round SMD Satin Nickel SMD6RTRMTBZ = 6" Round SMD Tuscan Bronze SMD6RTRMWH = 6" Round SMD White (paintable) SMD6STRMSN = 6" Square SMD Satin Nickel SMD6STRMTBZ = 6" Square SMD Tuscan Bronze SMD6STRMWH = 6" Square SMD White (paintable)</p> <p>T24HWKIT = Title 24 Cable harness kit used to convert incandescent and low voltage housings to LED</p> <p>SMD6ACCKIT = SMD6 accessory kit includes friction clips, torsion springs and a Edison screwbase adapter for recessed housing installation.</p>
Notes

Accessories

Designer Trims



SMD6RTRMWH
round, white (paintable)



SMD6RTRMSN
round, satin nickel



SMD6RTRMTBZ
round, tuscan bronze

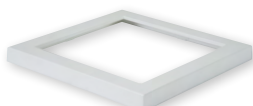

SMD6STRMWH
square, white (paintable)

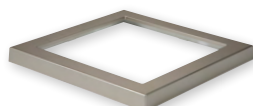

SMD6STRMSN
square, satin nickel



SMD6STRMTBZ
square, tuscan bronze

JUNCTION BOX COMPATIBILITY

***Note:** SMD 1200 lumen 120V configuration is only compatible with junction boxes 4" x 2-1/8" deep. Square junction box is required for 1200 lumen version.



TP316*
for non-metallic cable
4" x 4" x 2-1/8"
(102mm x 102mm x 54mm)



TP317*
for metal clad cable
4" x 4" x 2-1/8"
(102mm x 102mm x 54mm)



4" octagon light fixture/fan steel box*
4" x 4" x 2-1/8"
(102mm x 102mm x 54mm)



4" octagon steel box
4" x 4" x 1-1/2"
(102mm x 102mm x 38mm)



4" square deep steel box*
4" x 4" x 2-1/8"
(102mm x 102mm x 54mm)



4" square standard steel box
4" x 4" x 1-1/2"
(102mm x 102mm x 38mm)



4" round new work non-metallic light fixture/fan box
4" diameter x 2-3/16"
(102mm x 56mm)



3-1/2" round new work non-metallic ceiling box
3-1/2" diameter x 2-3/4"
(89mm x 70mm)



4" round surface mount box
4" diameter x 1-1/2"
(102mm x 38mm)
Requires SLD6RAD adapter



4" round new work non-metallic box with hanger bar assembly
4" diameter x 2-3/16" (102mm x 56mm)

This is a representative list of compatible junction boxes only. Information contained in this literature about other manufacturers' products is from published information made available by the manufacturer and is deemed to be reliable, but has not been verified. Cooper Lighting Solutions makes no specific recommendation on product selection and there are no warranties of performance or compatibility implied. Installer must determine that site conditions are suitable to allow proper installation of the mounting bracket in the box.

Product Specifications

Housing

- Non-electrically conductive polycarbonate frame.
- High impact diffuse polystyrene lens provides shielding to the light guide with no pixilation
- Stamped aluminum housing provides thermal cooling achieving L70 at 50,000 hours in IC and non-IC applications

Gaskets

- Closed cell gasket achieves restrictive airflow and wet location requirements without additional caulking

Optics

- Precision acrylic light guide organizes source flux into wide distribution with 1.2 – 1.4 spacing criteria useful for general area illumination

LED

- Mid power LED array provide a uniform source with high efficiency and long life
- Available in 90 CRI minimum, R9 greater than 50 and color accuracy within 3 SDCM provide color accuracy and uniformity

Driver

SMD 120V

- Integral 120V 50/60Hz constant current driver provides noise free operation
- Continuous, flicker-free dimming from 100% to 5% with select leading or trailing edge 120V phase cut dimmers
- Dimming to 5% is best assured using dimmers with low end trim adjustment. Consult dimmer manufacturer for compatibility and conditions of use. (Note some dimmers require a neutral in the wallbox.)
- Inline electrical quick connect and E26 adapter (provided) provides mains connections

SMD 120-277V

- Integrated 120-277V 60Hz constant current driver provides noise free operation
- SMD Universal Voltage (120-277V) configurations are recommended for use with compatible 0-10V DC
- low voltage dimmers only

Mounting/Retention

- Adjustable spider plate allows for quick installation into both junction boxes and recessed housings
- Torsion springs and friction blades included

Electrical Junction Box Mounting

- The SMD may be used in compatible electrical junction boxes in direct contact with insulation including spray foam insulation
- Suitable for installation in many 3-1/2" and 4" square, octagon, and round electrical junction boxes
Note: SMD120-277V UNV is only compatible with junction boxes that provide minimum depth of 2-1/8"
- Installer must ensure compatibility of fit, wiring and proper mounting in the electrical junction box. This includes all applicable national and local electrical and building coded

Recessed Housing Mounting

Note: Use the SMDACCKIT which includes torsion springs and Edison base adapter. (SOLD SEPERATELY)

- May be installed in IC recessed housings in direct contact with insulation

Note: Not for use in recessed housing in direct contact with spray foam insulation. Refer to NEMA LSD 57-2013

Designer Skins (Sold Separately)

- SMD skins are accessory rings in both round and square. These skins attach to the SMD for a permanent finish. Refer to the SMD accessories specification sheet for details
 - Matte White (Paintable)
 - Satin Nickel
 - Tuscan Bronze

Compliance

- cULus Certified for use with Halo housings and for use with other's housings, , when used with SMDACCKIT (Sold Separately) see instruction sheet for conditions of acceptability
- Wet and Damp Location listed, airtight per ASTM-E283
- Suitable for use in closets, compliant with NFPA® 70, NEC® Section 410.16 (A)(3) and 410.16 (C)(5)
- EMI/RFI emissions per FCC 47CFR Part 15B
- Contains no mercury or lead and RoHS compliant.
- Photometric testing in accordance with IES LM-79-08
- Lumen maintenance projections in accordance with IES LM-80-08 and TM-21-11
- Can be used for State of California Title 24 high efficacy luminaire compliance, reference the California Energy Commission Title 20 Appliance Efficiency Database for current listings
- Can be used for International Energy Conservation Code (IECC) and high efficiency luminaire compliance
- ENERGY STAR® listed, reference database for current listings

Warranty

- Five year limited warranty, consult website for details. www.cooperlighting.com/legal

Energy Data

SMD6R6 / SMD6S6

	Round	Square
Lumens (5000K models)	777	800
Input Power	9 W	9 W
Input Current	0.085 A	0.085 A
Efficiency	86 lm/W	85 lm/W
THDi	8	8
Input Voltage	120V	
Frequency	60 Hz	
CRI	90 CRI	
Power Factor	0.98	
T Ambient	-30 - +40°C	
Sound Rating	Class A	

SMD6R12 / SMD6S12

	Round	Square
Lumens (5000K models)	1271	1345
Input Power	15	15
Input Current	0.129 A	0.129 A
Efficiency	85 lm/W	88 lm/W
THDi	12.6	12.6
Input Voltage	120V	
Frequency	60 Hz	
CRI	90 CRI	
Power Factor	0.98	
T Ambient	-30 - +40°C	
Sound Rating	Class A	

SMD6R12-E / SMD6S12-E

	Round	Square
Lumens (5000K models)	1357	1364
Input Power	14.5	14.5
Input Current	0.125 A (120V) 0.058 A (277V)	0.125 A (120V) 0.058 A (277V)
Efficiency	94 lm/W	94 lm/W
THDi	12.8	12.8
Input Voltage	120 - 277V	
Frequency	60 Hz	
CRI	90 CRI	
Power Factor	0.99 (120V) 0.94 (277V)	
T Ambient	-30 - +40°C	
Sound Rating	Class A	

Photometric Data

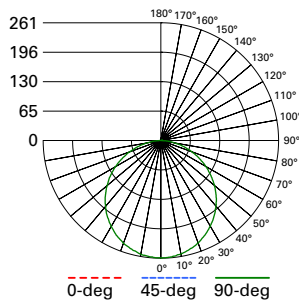

SMD6R69SWH - 3000K.IES
 Spacing criterion: (0-180) 1.26
 (90-270) 1.26
 (Diagonal) 1.38
 Beam Angle: 112°
 Lumens: 757
 Input Watts: 8.9 W
 Efficacy: 85 LPW
 Test Report:
 SMD6R69SWH - 3000K.IES

Zonal Lumen	Lumens	% Lumens
0-30	201	26.6
0-40	330	43.6
0-60	585	77.4
0-90	752	99.4

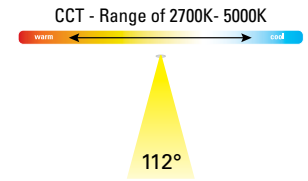

SMD6R69SWH	CCT	Watts	Lumens	LPW	CRI
600 Lumen 6" Round Selectable CCT	2700K	9.2	704	76.6	93
	3000K	9.2	716	77.8	93
	3500K	9.2	729	79.2	94
	4000K	9.2	742	80.5	94
	5000K	9.2	756	82.0	93

PRODUCT SPECIFICATIONS

Lumens	716
Watts	9.2
Lumens Per Watt (Efficacy)	77.8
Color Accuracy (CRI)	93
Light Color (CCT) <small>Correlated Color Temperature (CCT)</small>	3000K

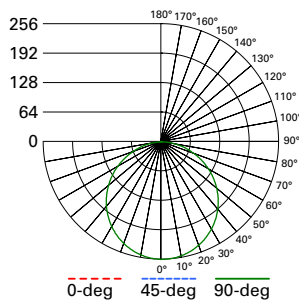

SMD6S69SWH - 3000K.IES
 Spacing criterion: (0-180) 1.28
 (90-270) 1.28
 (Diagonal) 1.40
 Beam Angle: 113°
 Lumens: 752
 Input Watts: 9.2 W
 Efficacy: 82 LPW
 Test Report:
 SMD6S69SWH - 3000K.IES

Zonal Lumen	Lumens	% Lumens
0-30	199	26.4
0-40	326	43.4
0-60	580	77.2
0-90	748	99.5

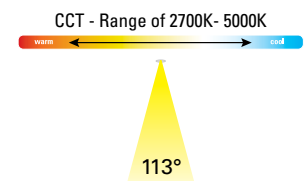

SMD6S69SWH	CCT	Watts	Lumens	LPW	CRI
600 Lumen 6" Square Selectable CCT	2700K	9.6	720	75.3	93
	3000K	9.6	735	76.7	93
	3500K	9.6	750	78.2	94
	4000K	9.6	764	79.5	94
	5000K	9.6	774	80.7	92

PRODUCT SPECIFICATIONS

Lumens	735
Watts	9.6
Lumens Per Watt (Efficacy)	76.6
Color Accuracy (CRI)	93
Light Color (CCT) <small>Correlated Color Temperature (CCT)</small>	3000K

Photometric Data

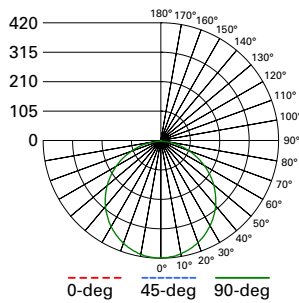

SMD6R129SWH - 3000K.IES
 Spacing criterion: (0-180) 1.26
 (90-270) 1.26
 (Diagonal) 1.38
 Beam Angle: 112°
 Lumens: 1221
 Input Watts: 14.9 W
 Efficacy: 82 LPW
 Test Report:
 SMD6R129SWH - 3000K.IES

Zonal Lumen	Lumens	% Lumens
0-30	325	26.6
0-40	533	43.6
0-60	945	77.4
0-90	1215	99.5

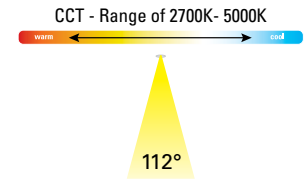

SMD6R129SWH	CCT	Watts	Lumens	LPW	CRI
1200 Lumen 6" Round Selectable CCT	2700K	15.2	1135	74.7	92
	3000K	15.2	1156	76.1	93
	3500K	15.2	1178	77.5	94
	4000K	15.2	1198	78.8	95
	5000K	15.2	1226	80.7	93

PRODUCT SPECIFICATIONS

Lumens	1156
Watts	15.2
Lumens Per Watt (Efficacy)	76.1
Color Accuracy (CRI)	93
Light Color (CCT) <small>Correlated Color Temperature (CCT)</small>	3000K

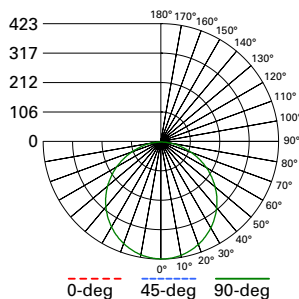

SMD6S129SWH - 3000K.IES
 Spacing criterion: (0-180) 1.26
 (90-270) 1.26
 (Diagonal) 1.40
 Beam Angle: 113°
 Lumens: 1241
 Input Watts: 14.9 W
 Efficacy: 83 LPW
 Test Report:
 SMD6S129SWH - 3000K.IES

Zonal Lumen	Lumens	% Lumens
0-30	329	26.5
0-40	539	43.5
0-60	960	77.3
0-90	1237	99.6

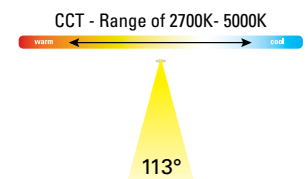

SMD6S129SWH	CCT	Watts	Lumens	LPW	CRI
1200 Lumen 6" Square Selectable CCT	2700K	15.5	1153	74.4	92
	3000K	15.5	1177	75.9	93
	3500K	15.5	1206	77.8	95
	4000K	15.5	1224	79.0	95
	5000K	15.4	1256	81.6	93

PRODUCT SPECIFICATIONS

Lumens	1177
Watts	15.5
Lumens Per Watt (Efficacy)	75.9
Color Accuracy (CRI)	93
Light Color (CCT) <small>Correlated Color Temperature (CCT)</small>	3000K

Photometric Data

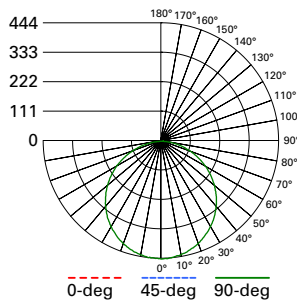

SMD6R129SWHE - 3000K.IES
 Spacing criterion: (0-180) 1.24
 (90-270) 1.24
 (Diagonal) 1.38
 Beam Angle: 112°
 Lumens: 1289
 Input Watts: 14.5 W
 Efficacy: 89 LPW
 Test Report:
 SMD6R129SWHE - 3000K.IES

Zonal Lumen	Lumens	% Lumens
0-30	343	26.6
0-40	562	43.6
0-60	997	77.3
0-90	1282	99.5

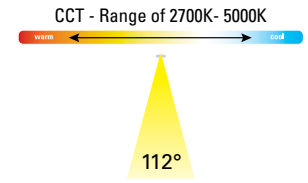

SMD6R129SWHE	CCT	Watts	Lumens	LPW	CRI
1200 Lumen 6" Round Selectable CCT 120-277V	2700K	14.7	1237	84.1	92
	3000K	14.7	1262	85.9	93
	3500K	14.7	1289	87.7	95
	4000K	14.7	1311	89.2	95
	5000K	14.7	1306	88.8	93

PRODUCT SPECIFICATIONS

Lumens	1262
Watts	14.7
Lumens Per Watt (Efficacy)	85.9
Color Accuracy (CRI)	93
Light Color (CCT) Correlated Color Temperature (CCT)	3000K

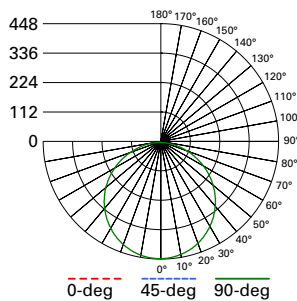

SMD6S129SWHE - 3000K.IES
 Spacing criterion: (0-180) 1.26
 (90-270) 1.26
 (Diagonal) 1.40
 Beam Angle: 114°
 Lumens: 1312
 Input Watts: 14.7 W
 Efficacy: 89 LPW
 Test Report:
 SMD6S129SWHE - 3000K.IES

Zonal Lumen	Lumens	% Lumens
0-30	348	26.5
0-40	570	43.5
0-60	1014	77.3
0-90	1307	99.6

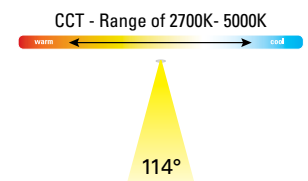

SMD6S129SWHE	CCT	Watts	Lumens	LPW	CRI
1200 Lumen 6" Square Selectable CCT 120-277V	2700K	15.1	1225	81.1	92
	3000K	15.1	1251	82.8	93
	3500K	15.1	1277	84.6	95
	4000K	15.1	1299	86.0	95
	5000K	15.1	1327	87.9	93

PRODUCT SPECIFICATIONS

Lumens	1251
Watts	15.1
Lumens Per Watt (Efficacy)	82.8
Color Accuracy (CRI)	93
Light Color (CCT) Correlated Color Temperature (CCT)	3000K