



ELLIOTT ELECTRIC SUPPLY

We Deliver...Lower Cost, Quality Products, & Personal Service

3804 South Street
75964-7263, TX Nacogdoches
Phone: 936-569-7941
Fax: 936-560-4685



ST75 3/4 STR Liq-Tite Conn *Appleton/Oz Gedney*

Catalog Number	ST75
Manufacturer	Appleton/Oz Gedney
Description	Liquid Tight Straight Connector, 3/4 In Trade Size, Zinc Electroplated, Straight Connection Orientation, 1.5 In Length, 1.5 In Diameter, Insulated, 3/4 In NPT Thread Size, Threaded Connection, 22 LB/100
Weight per unit	0.2400 (lbs/each)
Product Category	Liquid Tight Fittings

Features

connection	Threaded X Compression
------------	------------------------

Dimensions and Weight

Size	3/4 in
------	--------

Descriptions

Description	3/4 STR LIQ-TITE CONN
-------------	-----------------------

Manufacturer Information

Brand	APPLETON
GTIN	00781381679251
UPC	781381679251

Taxonomies, Classifications, and Categories

Category Description	METALLIC FITTINGS
Type	ST Series Straight Liquidtight Connector With Plain Throat

Packaging

Carton	25
Package	50
Weight Per each	0.24

Uses, Certifications, and Standards

standard	Class I, Division 2; UL 514B, E14814, CSA C22.2 No. 18.3, 065178, NEMA FB-1
----------	---

Liquidtight ST Series Plain Throat and STB Series Insulated Throat Connectors

For Liquidtight Flexible Metal Conduit

Suitable for use in Class I, Division 2

Applications

- Provides a dependable connection for liquidtight flexible metal conduit.

Features

- ST Series has plain throat.
- STB Series has insulated throat to protect against wire damage.
- Seals out oil, water, dust, dirt and fumes.
- Unique long ferrule with more pronounced threads provides over four times UL pull-out requirements.
- Ferrule provides maximum surface contact for better sealing and a continuous, permanent, positive metal-to-metal ground.
- Polypropylene sealing ring with locknut standard.
- Liquidtight/raintight/oiltight.
- Suitable for wet locations.
- Full, machined tapered threads (NPT).
- Compact design with small turning radius.
- Straight, 45° and 90° styles available in trade sizes 3/8" thru 4"

Standard Material/Finish

- 3/8" thru 1" straight: steel body and compression nut
- 1-1/4" thru 4" straight: malleable iron body and compression nut
- 3/8" thru 4" 45° and 90°: malleable iron body
- 3/8" thru 1" 45° and 90° caps: steel
- 1-1/4" thru 4" 45° and 90° caps: malleable iron
- 3/8" thru 1" ferrule: steel
- 1-1/4" thru 4" ferrule: aluminum
- Steel: zinc electroplate
- Malleable iron: zinc electroplate, chromate and epoxy powder coat/zinc electroplate
- Sealing ring: polypropylene

Certifications and Compliances

- UL Standard: 514B
- UL Listed: E14814
- CSA Standard C22.2 No. 18.3
- CSA Certified: 065178
- NEMA: FB-1

STD Conduit Thread Size

Flexible Conduit Size (Inches)	NPT Size
3/8	1/2
1/2	1/2
3/4	3/4
1	1
1-1/4	1-1/4
1-1/2	1-1/2
2	2
2-1/2	2-1/2
3	3
3-1/2	3-1/2
4	4
5	5



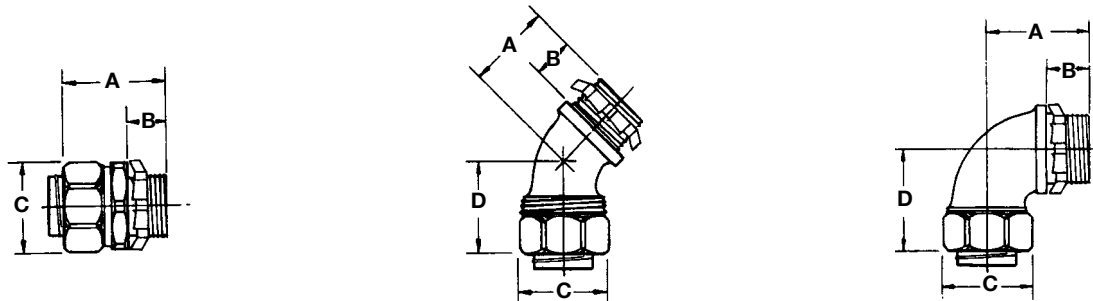

Dimensions



Liquidtight ST Series Plain Throat Connectors

For Liquidtight Flexible Metal Conduit

Suitable for use in Class I, Division 2

	Catalog Number	Conduit Size (Inches)	Dimensions in Inches/Millimeters				Weight Lbs./Kgs. Per 100
			A	B	C	D	
Straight							
	ST-38	3/8 flex, 1/2 hub	1.44/36.6	0.63/16.0	1.13/28.7	—	16.00/7.26
	ST-50	1/2	1.44/36.6	0.63/16.0	1.25/31.8	—	15.00/6.80
	ST-75	3/4	1.50/38.1	0.63/16.0	1.50/38.1	—	22.00/9.98
	ST-100	1	1.63/41.4	0.75/19.1	1.81/45.9	—	34.00/15.42
	ST-125	1-1/4	2.00/50.8	0.63/16.0	2.31/58.7	—	84.00/38.10
	ST-150	1-1/2	2.25/57.2	0.63/16.0	2.63/66.8	—	120.00/54.43
	ST-200	2	2.50/63.5	0.69/17.5	3.19/81.0	—	165.00/74.84
	ST-250	2-1/2	3.38/85.9	1.06/26.9	3.94/100.1	—	350.00/158.76
	ST-300	3	3.69/93.7	1.19/30.2	4.38/111.3	—	450.00/204.12
	ST-350	3-1/2	3.69/93.7	1.19/30.2	5.00/127.0	—	525.00/238.13
	ST-400	4	4.00/101.6	1.25/31.8	5.50/139.7	—	664.00/301.19
	45°						
	ST-4538	3/8 flex, 1/2 hub	0.88/22.4	0.63/16.0	1.13/28.7	1.13/28.7	19.00/8.62
	ST-4550	1/2	0.88/22.4	0.63/16.0	1.25/31.8	1.13/28.7	19.00/8.62
	ST-4575	3/4	1.13/28.7	0.63/16.0	1.50/38.1	1.25/31.8	32.00/14.51
	ST-45100	1	1.38/35.1	0.75/19.1	1.81/45.9	1.81/45.9	46.00/20.87
	ST-45125	1-1/4	1.63/41.4	0.63/16.0	2.31/58.7	1.81/45.9	103.00/46.72
	ST-45150	1-1/2	1.81/45.9	0.63/16.0	2.63/66.8	2.13/54.1	165.00/74.84
	ST-45200	2	2.00/50.8	0.69/17.5	3.19/81.0	2.38/60.5	245.00/111.13
	ST-45250	2-1/2	3.56/90.4	1.06/26.9	3.94/100.1	5.00/127.0	760.00/344.73
	ST-45300	3	4.31/109.5	1.19/30.2	4.38/111.3	5.81/147.6	962.00/436.36
	ST-45400	4	4.63/117.6	1.25/31.8	5.50/139.7	4.00/101.6	1512.00/685.83
90°							
	ST-9038	3/8 flex, 1/2 hub	1.25/31.8	0.63/16.0	1.13/28.7	1.50/38.1	22.80/10.34
	ST-9050	1/2	1.25/31.8	0.63/16.0	1.25/31.8	1.50/38.1	23.00/10.43
	ST-9075	3/4	1.44/36.6	0.63/16.0	1.50/38.1	1.56/39.6	39.00/17.69
	ST-90100	1	1.38/35.1	0.75/19.1	1.81/45.9	1.88/47.8	62.00/28.12
	ST-90125	1-1/4	1.81/45.9	0.63/16.0	2.31/58.7	2.38/60.5	114.00/51.71
	ST-90150	1-1/2	2.44/61.9	0.63/16.0	2.63/66.8	3.19/81.0	195.00/88.45
	ST-90200	2	2.63/66.8	0.69/17.5	3.19/81.0	3.56/90.4	290.00/131.54
	ST-90250	2-1/2	7.19/182.6	1.06/26.9	3.94/100.1	8.44/214.4	843.00/382.38
	ST-90300	3	8.63/219.2	1.19/30.2	4.38/111.3	10.13/257.3	1100.00/498.95
	ST-90400	4	11.25/285.8	1.25/31.8	5.50/139.7	12.81/325.4	2100.00/952.54



Commercial Products

COMMERCIAL PRODUCTS: LIQUIDTIGHT CONDUIT FITTINGS

Liquidtight STB Series Insulated Throat Connectors

For Liquidtight Flexible Metal Conduit

Suitable for use in Class I, Division 2

	Catalog Number	Conduit Size (Inches)	Dimensions in Inches/Millimeters				Weight Lbs./Kgs. Per 100
			A	B	C	D	
Straight							
	STB-38	3/8 flex, 1/2 hub	1.44/36.6	0.63/16.0	1.13/28.7	—	15.00/6.80
	STB-50	1/2	1.44/36.6	0.63/16.0	1.25/31.8	—	16.00/7.26
	STB-75	3/4	1.50/38.1	0.63/16.0	1.50/38.1	—	23.00/10.43
	STB-100	1	1.63/41.4	0.75/19.1	1.81/45.9	—	34.00/15.42
	STB-125	1-1/4	2.00/50.8	0.63/16.0	2.31/58.7	—	84.00/38.10
	STB-150	1-1/2	2.25/57.2	0.63/16.0	2.63/66.8	—	119.00/53.98
	STB-200	2	2.50/63.5	0.69/17.5	3.19/81.0	—	170.00/77.11
	STB-250	2-1/2	3.38/85.9	1.06/26.9	3.94/100.1	—	340.00/154.22
	STB-300	3	3.69/93.7	1.19/30.2	4.38/111.3	—	450.00/204.12
	STB-350	3-1/2	3.69/93.7	1.19/30.2	5.00/127.0	—	530.00/240.40
	STB-400	4	4.00/101.6	1.25/31.8	5.50/139.7	—	655.00/297.10
45°							
	STB-4538	3/8 flex, 1/2 hub	0.88/22.4	0.63/16.0	1.13/28.7	1.13/28.7	18.00/8.16
	STB-4550	1/2	0.88/22.4	0.63/16.0	1.25/31.8	1.13/28.7	18.00/8.16
	STB-4575	3/4	1.13/28.7	0.63/16.0	1.50/38.1	1.25/31.8	30.00/13.61
	STB-45100	1	1.38/35.1	0.75/19.1	1.81/45.9	1.81/45.9	49.00/22.23
	STB-45125	1-1/4	1.63/41.4	0.63/16.0	2.31/58.7	1.81/45.9	102.00/46.27
	STB-45150	1-1/2	1.81/45.9	0.63/16.0	2.63/66.8	2.13/54.1	160.00/72.57
	STB-45200	2	2.00/50.8	0.69/17.5	3.19/81.0	2.38/60.5	230.00/104.33
	STB-45250	2-1/2	3.56/90.4	1.06/26.9	3.94/100.1	5.00/127.0	760.00/344.73
	STB-45300	3	4.31/109.5	1.19/30.2	4.38/111.3	5.81/147.6	1000.00/453.59
	STB-45400	4	4.63/117.6	1.25/31.8	5.50/139.7	4.00/101.6	1800.00/816.47
90°							
	STB-9038	3/8 flex, 1/2 hub	1.25/31.8	0.63/16.0	1.13/28.7	1.50/38.1	23.00/10.43
	STB-9050	1/2	1.25/31.8	0.63/16.0	1.25/31.8	1.50/38.1	24.00/10.89
	STB-9075	3/4	1.44/36.6	0.63/16.0	1.50/38.1	1.56/39.6	38.00/17.24
	STB-90100	1	1.38/35.1	0.75/19.1	1.81/45.9	1.88/47.8	58.00/26.31
	STB-90125	1-1/4	1.81/45.9	0.63/16.0	2.31/58.7	2.38/60.5	116.00/52.62
	STB-90150	1-1/2	2.44/61.9	0.63/16.0	2.63/66.8	3.19/81.0	192.00/87.09
	STB-90200	2	2.63/66.8	0.69/17.5	3.19/81.0	3.56/90.4	282.00/127.91
	STB-90250	2-1/2	7.19/182.6	1.06/26.9	3.94/100.1	8.44/214.4	840.00/381.02
	STB-90300	3	8.63/219.2	1.19/30.2	4.38/111.3	10.13/257.3	1100.00/498.95
	STB-90400	4	11.25/285.8	1.25/31.8	5.50/139.7	12.81/325.4	2150.00/975.22

Commercial Products

COMMERCIAL PRODUCTS: LIQUIDTIGHT CONDUIT FITTINGS