



# ELLIOTT ELECTRIC SUPPLY

We Deliver...Lower Cost, Quality Products, & Personal Service

3804 South Street  
75964-7263, TX Nacogdoches  
Phone: 936-569-7941  
Fax: 936-560-4685



## TA42DU42 29-42A O.L. Relay

*Thomas&Betts-Abb Ins Prod*

Catalog Number	TA42DU42
Manufacturer	Thomas&Betts-Abb Ins Prod
Description	
Weight per unit	0.7700 (lbs/each)
Product Category	Overload Relays & Accessories

### Dimensions and Weight

Size	54x90x111mm
------	-------------

### Descriptions

Description	29-42A O.L. RELAY
Product Type	Relais Thermique 29...42a
Special Features	Degree of protection: IP20, IP10

### Manufacturer Information

Brand	ABB
GTIN	00662019885636
Manufacturers Part Number	TA42DU42
UPC	662019885636

### Taxonomies, Classifications, and Categories

Category Description	GENERAL PURPOSE RELAYS
Type	Overload relay

### Packaging

Carton	1
Weight Per each	0.77

### Uses, Certifications, and Standards

Application	Suitable for A30, A40, AL30, AL40
standard	RoHs, cUL, CE, GOST

# TA42DU thermal overload relays

## 18.0 ... 42.0 A

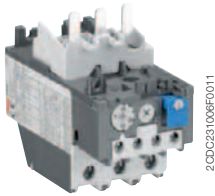

TA42DU-32

2CDC231006F0011

### Description

The TA42DU thermal overload relays are economic electromechanical protection devices for the main circuit. They offer reliable protection for motors in the event of overload or phase failure. The devices have trip class 10A.

The thermal overload relays are three pole relays with bimetal tripping elements. The motor current flows through the bimetal tripping elements and heats them directly and indirectly. In case of an overload (over current), the bimetal elements bent as a result of the heating. This leads to a release of the relay and a change of the contacts switching position (95-96 / 97-98).

- Manual or automatic reset selectable
- Phase loss sensitive acc. to IEC/EN 60947-4-1
- Two electrically isolated auxiliary contacts – 1 N.O. + 1 N.C.
- TEST and STOP function – Trip indication on the front
- Temperature compensation
- Suitable for three- and single-phase applications

### Ordering details

Setting range	Short-circuit protective device	Trip class	Type	Order code	Weight (1 pce) kg
A					
18 ... 25	63 A, Fuse type gG / 50 A aM	10A	TA42DU-25	1SAZ311201R1001	0.335
22 ... 32	80 A, Fuse type gG / 63 A aM	10A	TA42DU-32	1SAZ311201R1002	0.335
29 ... 42	100 A, Fuse type gG / 80 A aM	10A	TA42DU-42	1SAZ311201R1003	0.335

### Ordering details accessories

For thermal overload relays	Description	Type	Order code	Weight (1 pce) kg
TA42DU	Single mounting kit	DB80	1SAZ301110R0001	0.155

### Main dimensions mm, inches

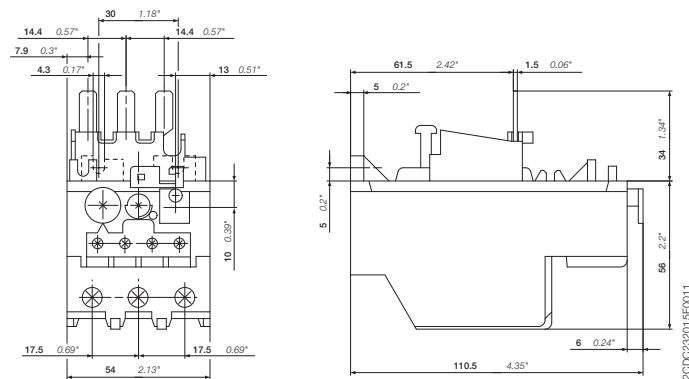

TA42DU

2CDC232015F0011

# TA42DU thermal overload relays

## Technical data

### Main circuit – Utilization characteristics according to IEC/EN

Type	TA42DU
Standards	IEC 60947-1 / 60947-4-1 and EN 60947-1 / 60947-4-1
Rated operational voltage $U_e$	690 V AC
Rated frequency	DC, 50/60 Hz
Trip class	10A
Number of poles	3
Duty time	100 %
Operating frequency without early tripping	Up to 15 operations/h, see "Technical diagram – Intermittent periodic duty"
Rated impulse withstand voltage $U_{imp}$	6 kV
Rated insulation voltage $U_i$	690 V AC

### Auxiliary circuit according to IEC/EN

Type	TA42DU
Rated operational voltage $U_e$	500 V AC, 440 V DC
Conventional free air thermal current $I_{th}$	N.C., 95-96 10 A N.O., 97-98 6 A
Rated frequency	DC, 50/60 Hz
Number of poles	1 N.O. + 1 N.C.
$I_e$ / Rated operational current AC-15 acc. to IEC/EN 60947-5-1 for utilization category	
110-120 V	N.C., 95-96 3.00 A N.O., 97-98 3.00 A
220-230-240 V	N.C., 95-96 3.00 A N.O., 97-98 3.00 A
440 V	N.C., 95-96 1.90 A N.O., 97-98 1.00 A
480-500 V	N.C., 95-96 1.00 A N.O., 97-98 1.00 A
$I_e$ / Rated operational current DC-13 acc. to IEC/EN 60947-5-1 for utilization category	
24 V	N.C., 95-96 1.25 A N.O., 97-98 1.25 A
60 V	N.C., 95-96 0.25 A N.O., 97-98 0.25 A
110-120-125 V	N.C., 95-96 0.25 A N.O., 97-98 0.25 A
250 V	N.C., 95-96 0.12 A N.O., 97-98 0.04 A
Minimum switching capacity	17 V / 3 mA
Short-circuit protective device	N.C., 95-96 10 A, Fuse type gG N.O., 97-98 6 A, Fuse type gG
Rated impulse withstand voltage $U_{imp}$	6 kV
Rated insulation voltage $U_i$	690 V

### Technical diagram – Intermittent periodic duty

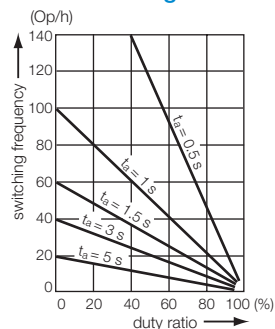

$t_s$ : Motor starting time

# TA42DU thermal overload relays

## Technical data

### Main circuit – Utilization characteristics according to UL/CSA

Type	TA42DU
Standards	UL 508, CSA 22.2 No. 14
Maximum operational voltage	600 V AC
Trip rating	125 % of FLA
Full load amps (FLA)	See table "Full load amps and short-circuit protective device"
Short-circuit rating RMS symmetrical	See table "Full load amps and short-circuit protective device"
Short-circuit protective device	See table "Full load amps and short-circuit protective device"

### Auxiliary circuit according to UL/CSA

Type	TA42DU
Contact rating	N.C., 95-96 C600 N.O., 97-98 B600
Conventional thermal current	5 A

### Full load amps and short-circuit protective device

Type	Full load amps (FLA)	Short-circuit protective device						
		480 / 600 V AC		Listed circuit breaker		Listed circuit breaker		Fuse type
		Short circuit rating RMS symmetrical	Fuse type	Listed circuit breaker	Short circuit rating RMS symmetrical	Listed circuit breaker	Short circuit rating RMS symmetrical	Fuse type
TA42DU-25	25 A	5 kA	80 A, K5/ RK5	80 A	35 / 18 kA	80 A	50 kA	100 A, Class J
TA42DU-32	32 A	5 kA	100 A, K5/ RK5	80 A	35 / 18 kA	80 A	50 kA	100 A, Class J
TA42DU-42	42 A	5 kA	150 A, K5/ RK5	80 A	35 / 18 kA	80 A	50 kA	200 A, Class J

# TA42DU thermal overload relays

## Technical data



### General technical data

Type	TA42DU	
Pollution degree	3	
Phase loss sensitive	Yes	
Ambient air temperature		
Operation	Open - compensated without derating	-25 ... +55 °C
	Open	-25 ... +55 °C
Storage	-40 ... +70 °C	
Ambient air temperature compensation	Continuous	
Maximum operating altitude permissible	2000 m	
Resistance to shock acc. to IEC 60068-2-27	12 g / 15 ms	
Mounting position	Position 1-6	
Mounting	Mount on the contactor and tighten the screws of the main circuit terminals or with single mounting kit on DIN rail (35 mm)	
Degree of protection	IP20	





### Electrical connection

6

#### Main circuit

Type	TA42DU	
Connecting capacity		
 Rigid	1 x	2.5 ... 25 mm <sup>2</sup>
	2 x	2.5 ... 16 mm <sup>2</sup>
 Flexible with insulated ferrule	1 x	2.5 ... 25 mm <sup>2</sup>
	2 x	2.5 ... 10 mm <sup>2</sup>
	1 x or 2 x	AWG 8-1
Stranded acc. to UL/CSA	1 x or 2 x	AWG 8-1
Flexible acc. to UL/CSA	1 x or 2 x	AWG 8-1
Stripping length	14 mm	
Tightening torques	4.5 Nm / 40 lb.in	
Connection screw	M6 (Pozi driv 2)	

#### Auxiliary circuit

Type	TA42DU	
Connecting capacity		
 Rigid	1 x or 2 x	0.75 ... 4 mm <sup>2</sup>
 Flexible with ferrule	1 x or 2 x	0.75 ... 2.5 mm <sup>2</sup>
 Flexible with insulated ferrule	1 x or 2 x	0.75 ... 2.5 mm <sup>2</sup>
 Flexible	1 x or 2 x	0.75 ... 2.5 mm <sup>2</sup>
	1 x or 2 x	AWG 18-14
Stranded acc. to UL/CSA	1 x or 2 x	AWG 18-14
Flexible acc. to UL/CSA	1 x or 2 x	AWG 18-14
Stripping length	9 mm	
Tightening torques	0.8 ... 1.3 Nm / 12 lb.in	
Connection screw	M3.5 (Pozi driv 2)	