



High performance, wall mount LED Vaporproof fixture. A classic design with cutting edge LED technology. Comes with die cast guard and frosted globe.

Color: Natural

Weight: 5.8 lbs

Project:	Type:
Prepared By:	Date:

Driver Info		LED Info	
Type	Constant Current	Watts	13W
120V	0.13A	Color Temp	5000K (Cool)
208V	0.08A	Color Accuracy	65 CRI
240V	0.07A	L70 Lifespan	100,000 Hours
277V	0.06A	Lumens	729
Input Watts	15.1W	Efficacy	48.3 lm/W

Technical Specifications

Performance

Lifespan:

100,000-Hour LED lifespan based on IES LM-80 results and TM-21 calculations

Construction

Globes and Guards:

Vaporproof LEDs are compatible with RAB Globes and Guards

Construction:

Die cast aluminum housing and door. Tether connects back housing halves for safety.

Cold Weather Starting:

Minimum starting temperature is -40°C (-40°F)

Ambient Temperature:

Suitable for use in up to 35°C (95°F)

Housing:

Die-cast aluminum housing and driver housing

Mounting:

Three 1/2" NPS conduit entry points

Guard and Globe:

Shot blasted guard with frosted globe

Reflector:

High quality hydroformed semi-specular aluminum

Gaskets:

High-temperature Silicone

Finish:

Natural shot blasted aluminum

Green Technology:

Mercury and UV free. RoHS-compliant components.

Electrical

Driver:

Multi-chip single 13W high output long life LED Driver. Constant Current, 100V-277V, 50/60 Hz., 100-240VAC. 3-.15 Amps 277VAC. 15 Amps. Will deliver 70% of its initial lumens at 100,000 hours based on LM-80 Tests.

Surge Protection:

4kV

Technical Specifications (continued)

Compliance

IESNA LM-79 & IESNA LM-80 Testing:

RAB LED luminaires and LED components have been tested by an independent laboratory in accordance with IESNA LM-79 and LM-80.

UL Listed:

UL Listed Suitable for Wet locations as a Downlight

LED Characteristics

Color Consistency:

3-step MacAdam Ellipse binning to achieve consistent fixture-to-fixture color

Color Stability:

LED color temperature is warranted to shift no more than 200K in color temperature over a 5-year period

Color Uniformity:

RAB's range of Correlated Color Temperature follows the guidelines of the American National Standard for Specifications for the Chromaticity of Solid State Lighting (SSL) Products, ANSI C78.377-2017.

Other

Warranty:

RAB warrants that our LED products will be free from defects in materials and workmanship for a period of five (5) years from the date of delivery to the end user, including coverage of light output, color stability, driver performance and fixture finish. RAB's warranty is subject to all terms and conditions found at rablighting.com/warranty.

Equivalency:

Equivalent to 26W CFL

Buy American Act Compliance:

RAB values USA manufacturing! Upon request, RAB may be able to manufacture this product to be compliant with the Buy American Act (BAA). Please contact customer service to request a quote for the product to be made BAA compliant.

Optical

BUG Rating:

B0 U3 G1

Dimensions

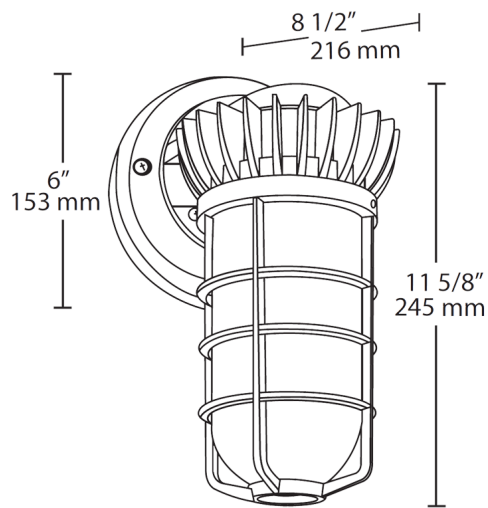

Features

- Vaporproof LED Wall Mount
- Superior Thermal Management (Patent Pending)
- All Die-Cast Aluminum Construction
- 100,000-hour life based on LM-80 results and TM-21 calculations
- Thermal Shock-Resistant Frosted Glass Globe
- Traditional Look, Cutting-Edge Technology
- 5-Year, No-Compromise Warranty