



XFIT



KT-WPLED55-M1-8CSB-VDIM

TRADITIONAL NON-CUTOFF LED WALL PACK

DESCRIPTION

Traditional 55W Non-Cutoff LED Wall Pack | 120–277V Input | 3000–5000K | Medium-Size Housing | Bronze Finish | Glass Lens

APPLICATION

Building mount for exterior illumination (perimeters, pathways, loading docks, and other general security lighting requirements)



5 YEAR
WARRANTY

PRODUCT FEATURES

- Keystone Color Select technology (3000/4000/5000K)
- Traditional design that matches appearance and light distribution pattern of legacy HID fixtures. Optimized for one-for-one replacements
- Heavy duty die cast aluminum housing with (5) 1/2" threaded conduit hubs: (1) on back and (1) on all four sides
- Powered by Keystone 0–10V dimming LED drivers
- Built-in dusk-to-dawn photocell behind translucent 3/4" threaded plug with anti-yellowing agent
- Borosilicate glass lens diffuses light source and provides uniform distribution
- Covers footprint of mid-size HID wallpacks
- Ambient operating temperature: –40°C/–40°F to 50°C/122°F
- UL Certified for wet locations; IP65 rated
- Fixture impact rating IK06
- Power Factor: >0.95
- THD: <20%
- LED chip lifetime: L70 >100,000 hrs @ 25°C/77°F ambient fixture temperature
- Meets FCC Part 15, Part B, Class A standards for conducted and radiated emissions
- **Compatible with Keystone LED Emergency Backups. See Accessories page for more details**

PRODUCT SPECIFICATIONS

Catalog Number	Wattage	Selectable CCT*	Lumens	Lumens Below 90°	Efficacy	Input Voltage	Dimming	CRI	Rated Life	Legacy Equivalent	Housing Color
KT-WPLED55-M1-8CSB-VDIM	55W	3000K	7200	6480	131 lm/W	120–277V	0–10V	>80	50,000 hrs	175–250W MH	Bronze
		4000K	7690	6895	140 lm/W						
		5000K	7450	6705	135 lm/W						

* Color Uniformity: CCT (Correlated Color Temperature) range as per guidelines outlined in ANSI C78.377-2017



KT-WPLED55-M1-8CSB-VDIM

TRADITIONAL NON-CUTOFF LED WALL PACK

PHYSICAL SPECIFICATIONS

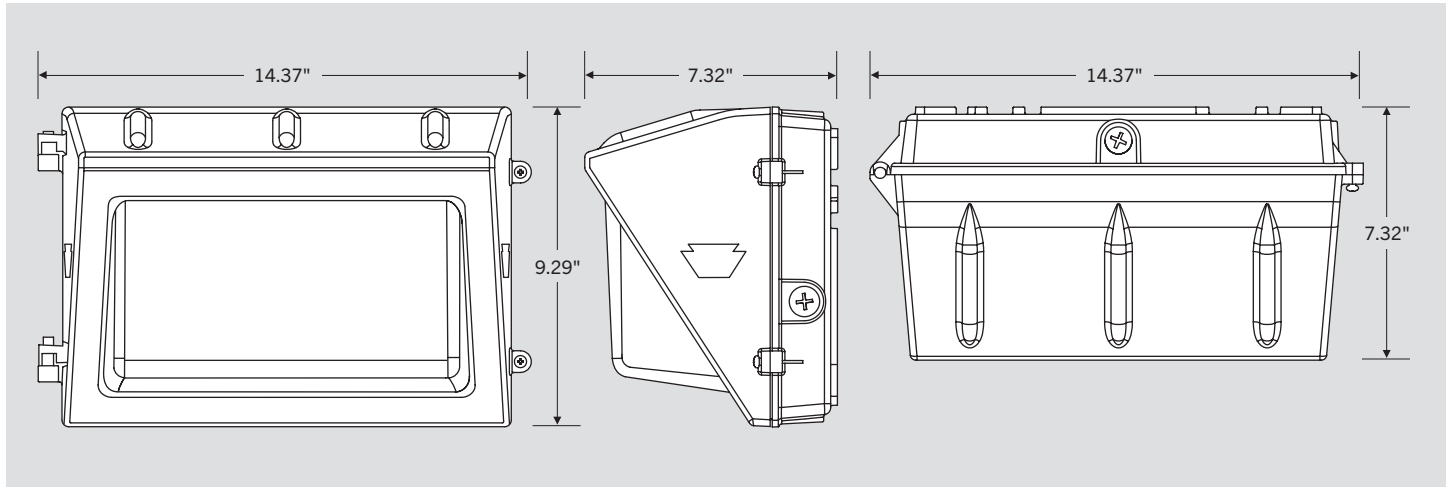

GENERAL SETUP INSTRUCTIONS

GENERAL WIRING DIAGRAM

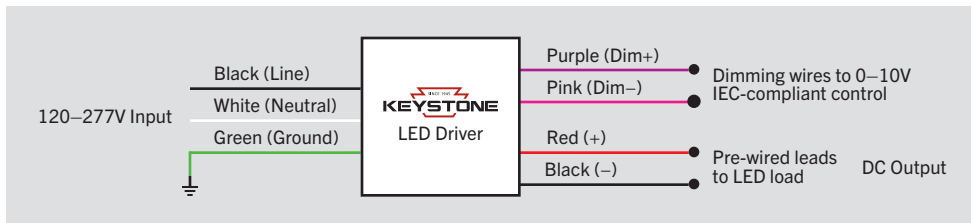

Caution: Before installing, make certain that AC power to the fixture is off.

Caution: The electrical rating of this product is 120–277V. Installer must confirm that there is 120–277V at the fixture before installation.

PHOTOCELL ENABLE/DISABLE

This fixture is equipped with a dusk-to-dawn photocell behind the translucent knock-out (KO) cover. Adjust the dip switch to enable (ON) or disable (OFF) the photocell function (see illustrations to the right). Fixture comes pre-set with photocell enabled unless otherwise noted.

COLOR SELECT (CCT) ADJUSTMENT

This fixture is equipped with Color Select technology. There is an adjustable dip switch behind the translucent knock-out (KO) cover to change CCT between 5000K, 4000K, and 3000K (see illustrations to the right). Fixture comes preset at 5000K unless otherwise noted.

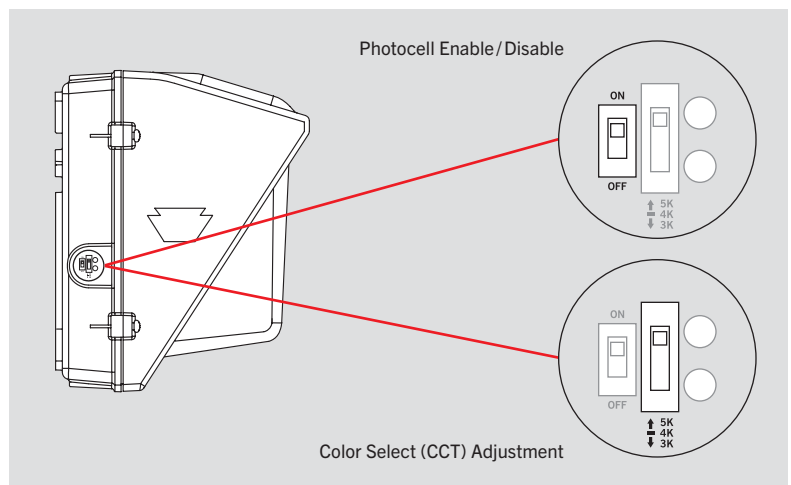

KT-WPLED55-M1-8CSB-VDIM

TRADITIONAL NON-CUTOFF LED WALL PACK

PHOTOMETRIC SPECIFICATIONS

ISOCANDELA PLOT

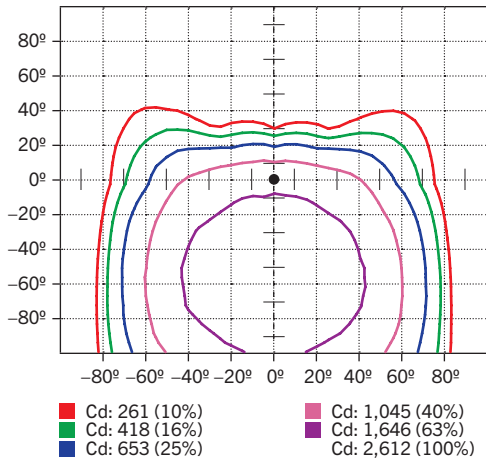

LUMINOUS INTENSITY DISTRIBUTION

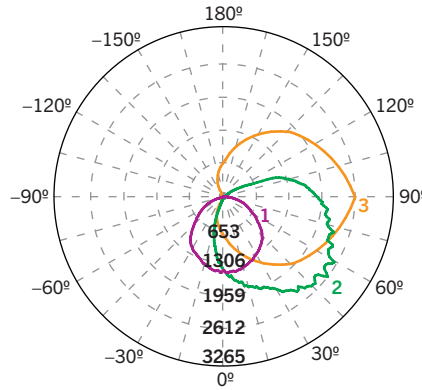

Average diffuse angle (50%): 109.9°

1 Violet C0 – C180

2 Green C90 – C270

3 Orange G52

Unit: cd

FLUX DISTRIBUTION

Zone	Lumens	% Luminaire
Forward Light	6,006 lm	81.9%
0°–30°	734 lm	10.0%
30°–60°	2,633 lm	35.9%
60°–80°	1,981 lm	27.0%
80°–90°	658 lm	9.0%
Back Light	629 lm	8.6%
0°–30°	241 lm	3.3%
30°–60°	294 lm	4.0%
60°–80°	80 lm	1.1%
80°–90°	15 lm	0.2%
Up Light	691 lm	9.5%
90°–100°	313 lm	4.3%
100°–180°	378 lm	5.2%

BUG* Rating

Asymmetrical Luminaire Types

Type I, II, III, IV B1 U3 G4

Quadrilateral Symmetrical Luminaire Types

Type V, Area Light B1 U3 G4

* Backlight, Uplight, Glare

MOUNTING

Side view

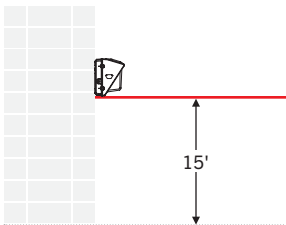

LIGHT DISTRIBUTION PATTERN

Isometric view from above; Luminaire mounted at 15'

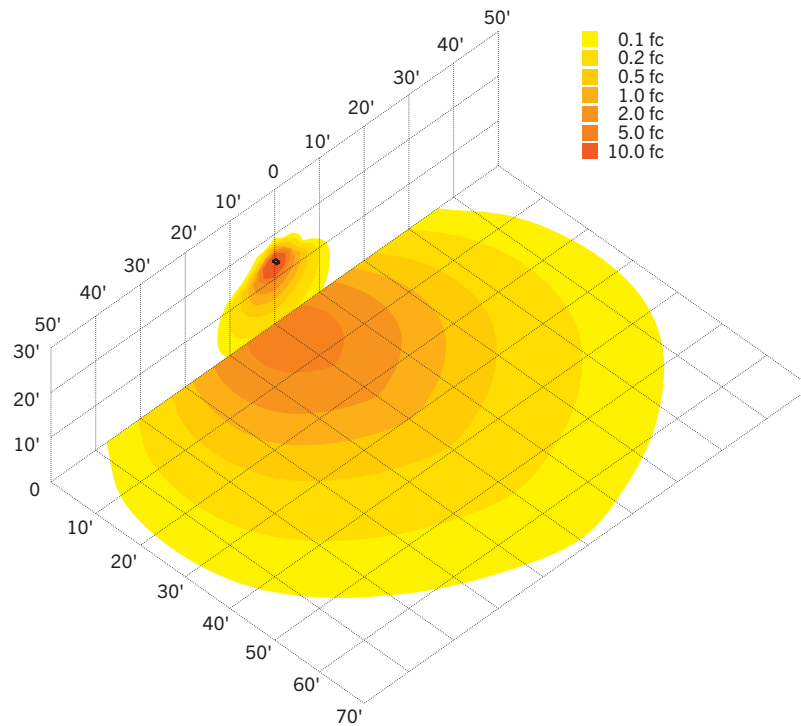

KT-WPLED55-M1-8CSB-VDIM

TRADITIONAL NON-CUTOFF LED WALL PACK

ACCESSORIES

SENSORS

Factory-Installable OR Field-Installable (field-installable purchased separately)

✓	SUFFIX*	CATALOG NUMBER	DESCRIPTION	UPC	EASY CODE
	/MW3	KTS-MW3-UV-KO-K1	Microwave Sensor Kit, Includes 120-277V input to 12V DC convertor & 12V input sensor head, IP65. Bi-Level Control with Adjustable Hold Time, Dim Level and Standby Time. Installs via standard 1/2in KO	843654134147	BKG-51



* For factory installation of accessory, add suffix to fixture part number (see ordering examples and instructions on last page of spec sheet).

CORD SETS

Factory-Installable OR Field-Installable (field-installable purchased separately)

✓	SUFFIX*	CATALOG NUMBER	DESCRIPTION	UPC	EASY CODE
	/515P6	KT-CS-515P-6-18/3	Cord set for high bay; 125V NEMA 5-15P; straight blade plug; 6' SJTOW cable; 18/3 wire	843654140124	UKH-26
	/L515P6	KT-CS-L515P-6-16/3	Cord set for high bays; 250V NEMA L5-15P; twist lock plug; 6' SJTOW cable; 16/3 wire	843654140186	POC-82

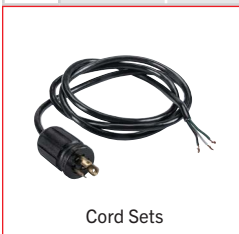

* For factory installation of accessory, add suffix to fixture part number (see ordering examples and instructions on last page of spec sheet).
Note: For cord sets not listed here, please contact your Keystone sales rep.

EMERGENCY BACKUP

Factory-Installable OR Field-Installable (field-installable purchased separately)

✓	SUFFIX*	CATALOG NUMBER	DESCRIPTION	UPC	EASY CODE
	/EM12	KT-EMRG-LED-12C-1200	LED Emergency Back-Up, 12W Constant Wattage Design. Approx 1200 Lumens. 120-277V Input. Remote Compact Battery Pack. CEC T20 Compliant.	843654103112	OJQ-32
	-	KT-EMRG-LED2-TS-IP65	IP65 Rated Wet Location Test Switch for 5W and 12W CEC Compliant LED Emergency Packs	843654130019	MDB-29

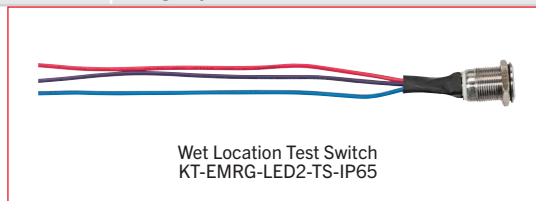

* For factory installation of accessory, add suffix to fixture part number (see ordering examples and instructions on last page of spec sheet).
† Factory installation of emergency backup units will automatically include any relevant mounting bracket.

(Accessories continued on next page)



KT-WPLED55-M1-8CSB-VDIM

TRADITIONAL NON-CUTOFF LED WALL PACK

ACCESSORIES (continued)

MOUNTS AND BRACKETS

Field-Installable / Field-Use ONLY (purchased separately)

✓	SUFFIX*	CATALOG NUMBER	DESCRIPTION	UPC	EASY CODE
	-	KT-WPLED-BP-M	Back Plate for Medium Size Wallpacks, Covers Legacy Style Large HID Housing Dimensions. Standard Bronze Color.	843654130613	CCJ-21



Back Plate
KT-WPLED-BP-M

* For factory installation of accessory, add suffix to fixture part number (see ordering examples and instructions on last page of spec sheet).
Note: This is needed with EM - will be added when factory installing EM

SURGE PROTECTORS

Factory-Installable OR Field-Installable (field-installable purchased separately)

✓	SUFFIX*	CATALOG NUMBER	DESCRIPTION	UPC	EASY CODE
	/10KV	KTSP-10KV-C	External Surge Protector, compact design. Parallel Wiring, 120-277V Input, Max Peak Protection (10KV, 10KA)	843654129204	BUU-26



External Surge Protector
KTSP-10KV-C

* For factory installation of accessory, add suffix to fixture part number (see ordering examples and instructions on last page of spec sheet).



KT-WPLED55-M1-8CSB-VDIM

TRADITIONAL NON-CUTOFF LED WALL PACK

ORDERING INFORMATION

CATALOG NUMBER	PACK QTY.	UPC	EASY CODE	DLC PRODUCT ID
KT-WPLED55-M1-8CSB-VDIM	1	843654129020	BYJ-72	PAGLBR8W

CATALOG NUMBER BREAKDOWN

KT-WPLED55-M1-8CSB-VDIM

1	2	3	4	5	6	7	8	9	10	11
1 Keystone Technologies	2 Fixture Type	3 LED Lamp	4 Wattage	5 Size	6 Style	7 CRI	8 Color	9 Color Select Designation	10 Dimming	11 Accessories (see below for details)
	WP Wallpack			M Medium	1 Non-Cutoff	8 >80	CS Color Select	B 3000/4000/5000K		
						VDIM 0-10V				

ORDERING EXAMPLES

FIXTURE WITH MULTIPLE FACTORY-INSTALLED ACCESSORIES*
KT-WPLED55-M1-8CSB-VDIM /MW3/515P6/EM12

FIXTURE WITH SINGLE FACTORY-INSTALLED ACCESSORY
KT-WPLED55-M1-8CSB-VDIM /MW3

FIXTURE WITH NO FACTORY-INSTALLED ACCESSORIES
KT-WPLED55-M1-8CSB-VDIM

* When ordering more than one factory-installed accessory, use multiple suffixes as shown in the ordering examples above.
 Note: All accessories can also be ordered separately for field installation using just their regular Catalog Number, UPC, or Easy Code.

KEYSTONE FIXTURE	
CATALOG NUMBER	
	KT-WPLED55-M1-8CSB-VDIM

SENSORS	
✓ SUFFIX	CATALOG NUMBER
/MW3	KTS-MW3-UV-KO-K1

CORD SETS	
✓ SUFFIX	CATALOG NUMBER
/515P6	KT-CS-515P-6-18/3

EMERGENCY BACKUP	
✓ SUFFIX	CATALOG NUMBER
/EM12	KT-EMRG-LED-12C-1200