

# WPTS70

HPS "Tall" Wallpack. Vandal resistant polycarbonate housing. Heavy die-cast aluminum back plate with 1/2" bottom and back conduit knockout. Factory installed 120V photocell with bypass cap included. Glare shield included. Lamp supplied.

Color: Bronze

Weight: 6.2 lbs

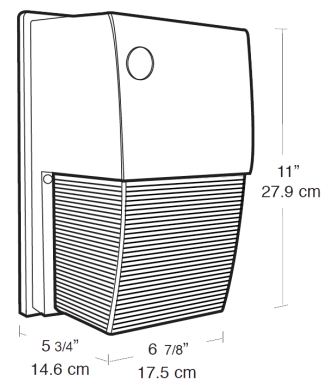

## Lamp Info

Type: ED17  
 Watts: 70W  
 Shape/Size: N/A  
 Base: N/A  
 ANSI: N/A  
 Hours: 24,000  
 Lamp Lumens: 6,300  
 Efficacy: 73 LPW

## Ballast Info

Type: R-NPF 120V  
 120V: 2.1/1.6A  
 208V: N/A  
 240V: N/A  
 277V: N/A  
 Input Watts: 86W  
 Efficiency: 81%

## Technical Specifications

### UL Listing:

Suitable for wet locations.

### Reflector:

Die formed aluminum for wide light distribution.  
 Moveable Glare Shield for field adjustable light control  
 slanted slightly downward for more light on the job.

### Ballast Housing:

Stamped steel painted white.

### Back Plate:

Heavy die cast aluminum. 1/2" bottom conduit knockout.  
 Knockouts for mounting to 3" or 4" junction boxes.

### Housing and Refractor:

Vandal resistant polycarbonate molded refractor. Die cast aluminum back plate.

### Patents:

The unique RAB Tallpack is protected by U.S. Patent D569,029; China Patent ZL200730149211.2; Taiwan Patent D124,864 and Canada Patent D121,993.